

Top Floor

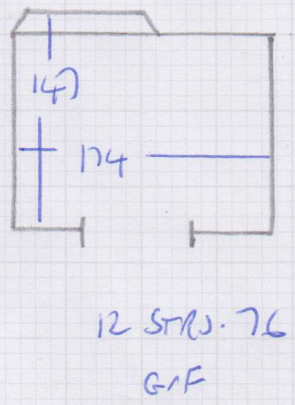

Job No: R17864
 Name: MCCLEAN
 Address: 130-132 TALBOT ROAD
 W11 1JA
 Tel: _____
 Sheet: _____ of: _____

GROUND FLOOR HALL
 F10

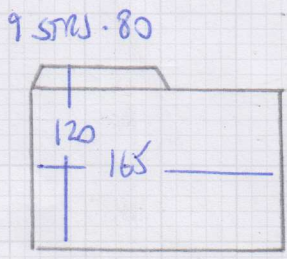
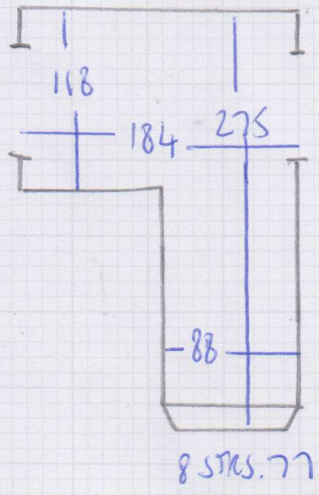
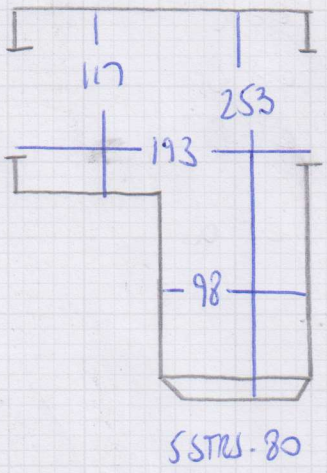
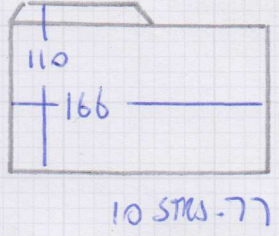
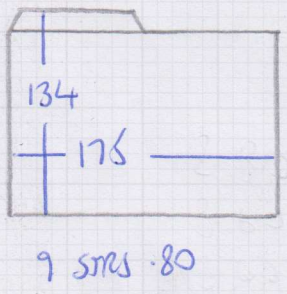
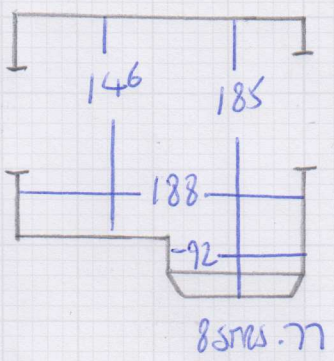
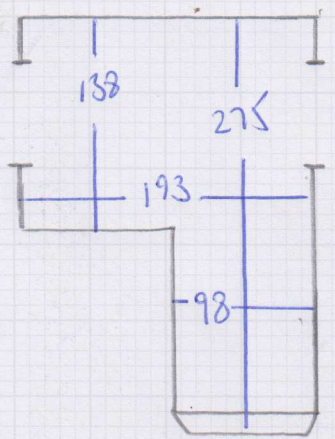

FATS TO KEEP OWN F10 BAYS?
 EXISTING CARPET ON OIL BASE
 THINK IT IS WOODEN FLOOR.