

Job No: F 23390
 Name: O'MAHONY
 Address: FAT A
 15 MURKIN AVE
 Tel: W14 8UJ
 Sheet: 1 of 4

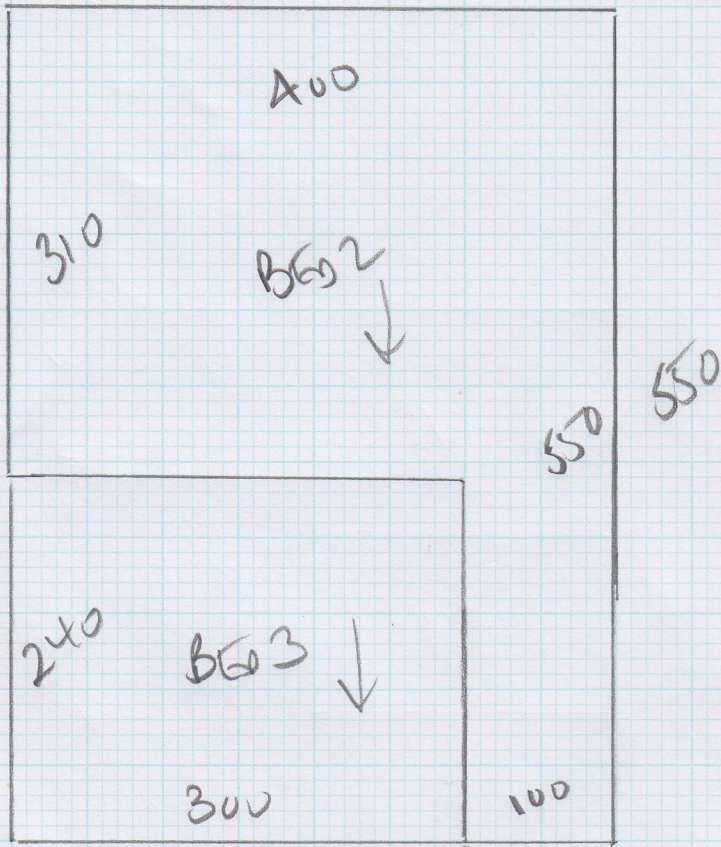

HANOI BB36

BED 1 A00 x A00

PLAN 550 x A00

9.90 x A00

39.60m²

Job No: F23390

Name: OMATHUNJ

Address:

Tel:

Sheet: 2 of 4

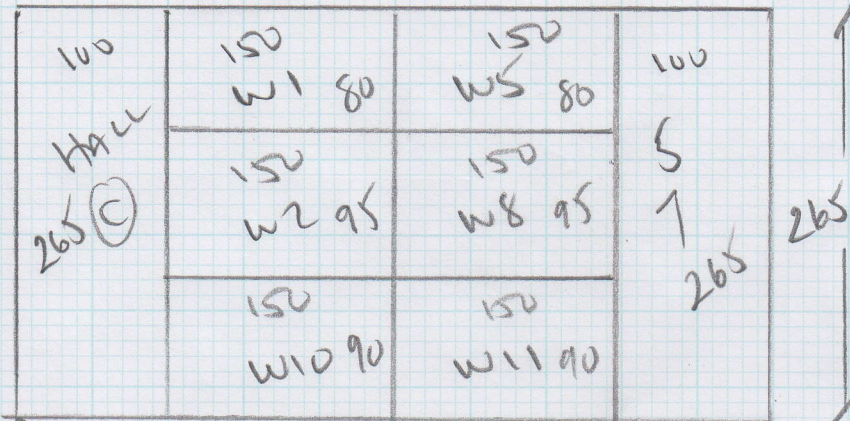

SAVANNAH
CORAL 199

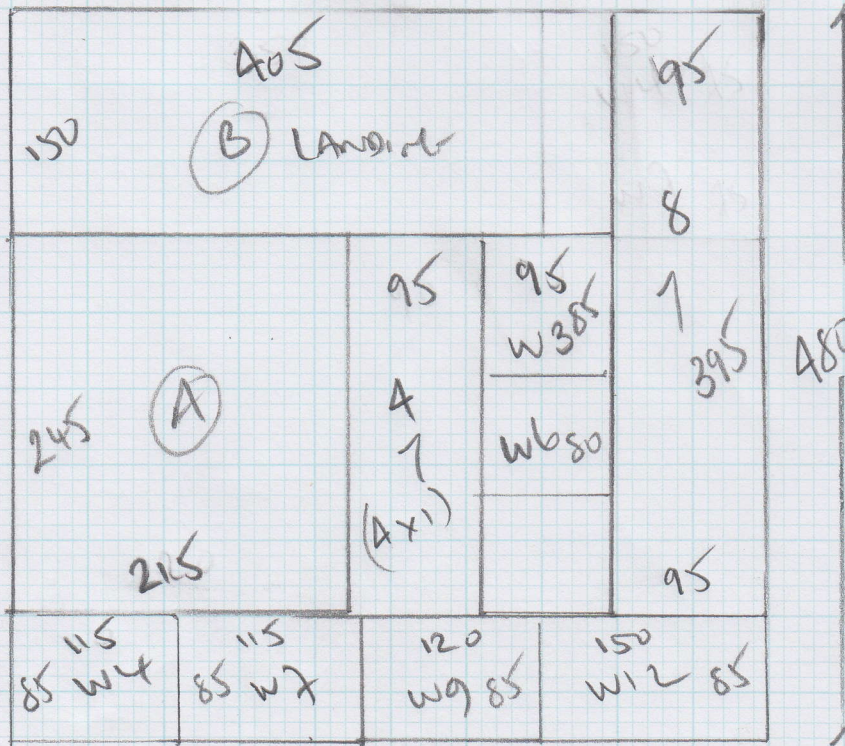

RAN1 265 x 500
RAN2 480 x 500
745 x 500

3725 m²

Job No: f23390
 Name: O'MAHONY
 Address: FLAT 4 - 15 MORNINGTON
 AVENUE, WIL4 8UJ
 Tel:
 Sheet: 3 of 4

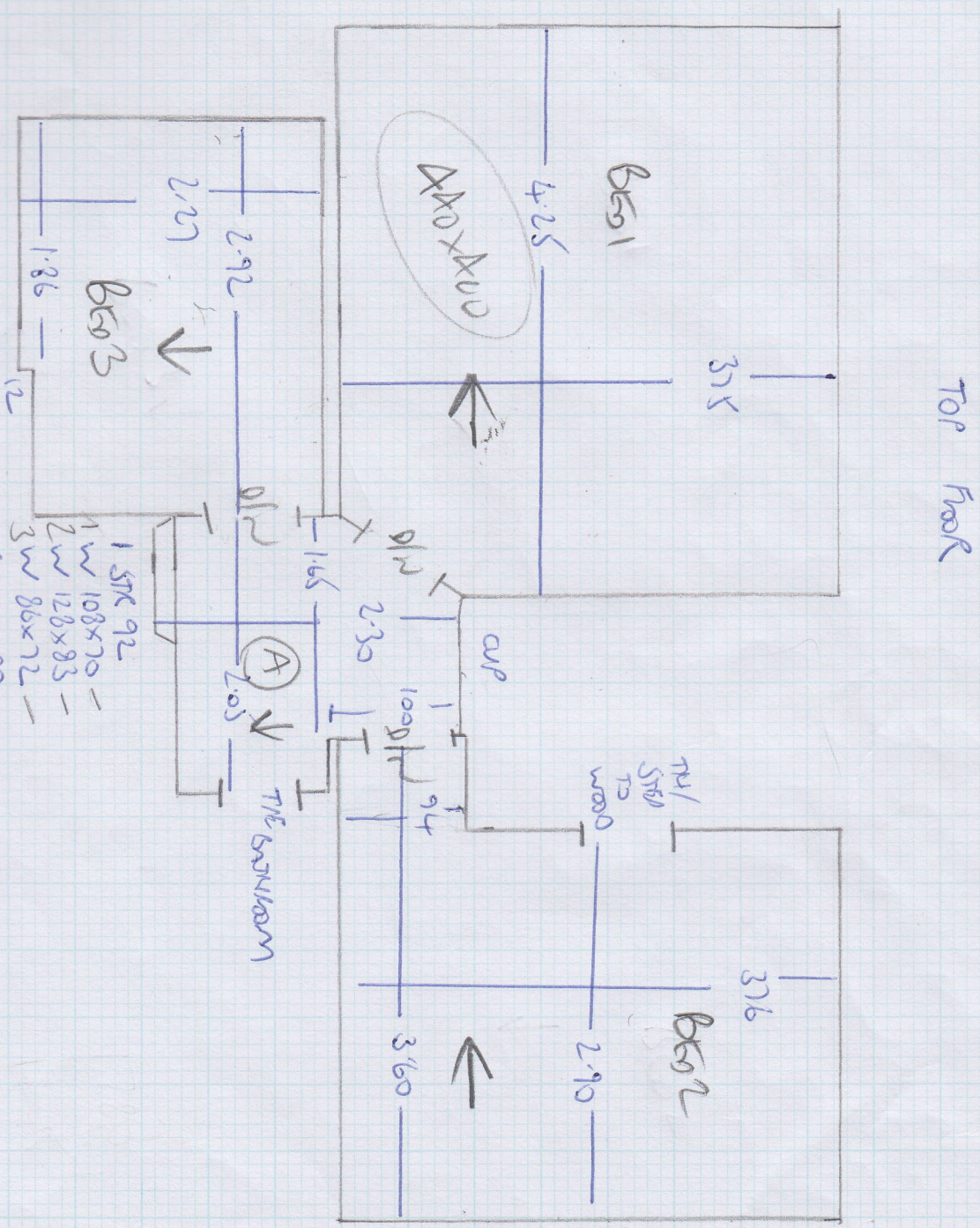

- 1 STR 92
- 1 W 108x70
- 2 W 128x83
- 3 W 86x72
- 5 STRS - 89
- 4 W 105x68
- 8 W 130x75
- 6 W 92x67
- 1 STR - 95

Job No: F23390
 Name: O'MAHONY
 Address: FLAT 4 - 15 MOWINGTON AVENUE, WILT ST
 Tel:
 Sheet: A of 4

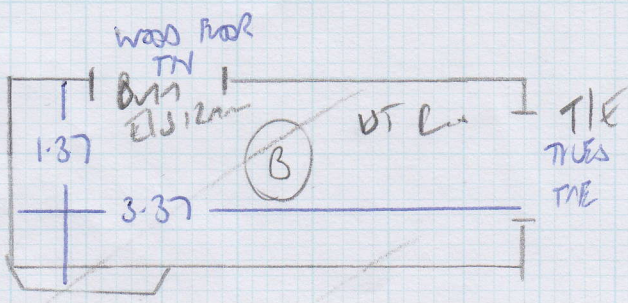

- 1 STR .90
- 7 W 1.07 x .70 -
- 8 W 1.30 x .80 -
- 9 W .90 x .72
- 8 STRS .90
- 10 W 1.07 x .70 -
- 11 W 1.27 x .80
- 12 W .90 x .74
- 1 STR .90

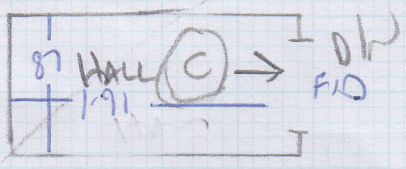

COMMUNAL AREAS

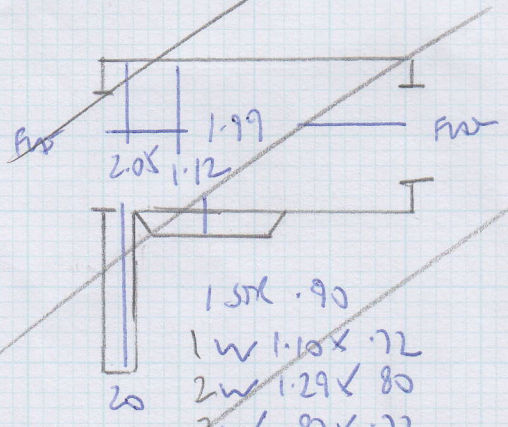

- 1 STR .90
- 1 W 1.10 x .72
- 2 W 1.29 x .80
- 3 W .87 x .72
- 10 STRS 90
- 4 W 1.05 x .88
- 5 W 1.28 x .75
- 6 W 93 x .75
- GIF

CORNER MAT
 100 x 60 (30 cm THICK)