

# janser

www.janser-uk.co.uk

## THE DURALAY INVISISEAMER

Designed by master carpet fitter, Jon Ward

Ideal for use with Durafit System

### INTRODUCTION

The Invisiseamer is made up of three components:-

1. The selvage cutter guide (3 positions).
2. The main plate - the centred section.
3. The base plate.

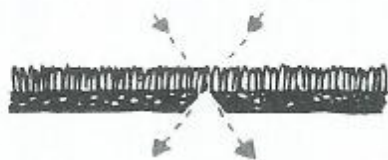
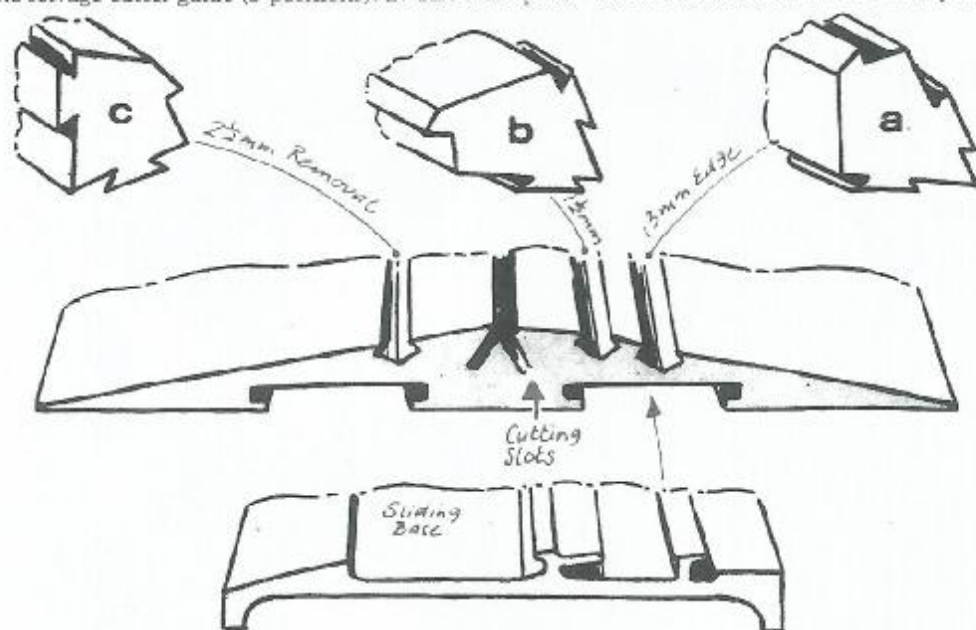

At all stages of use, the slot in the central section is where knife is placed and cutting is done holding the knife at an angle of 60°. Carpet edges are cut separately using the opposing angles - the purpose of which is to undercut the pile and prevent shearing.

### LONG SEAMS

STEP ONE: Remove base section and place selvage cutter guide in position A.

With the guide in this position, 1/2" can be removed from the side of the first piece of carpet to give a new joining edge.



Place knife in an upright position and following the angle of the centred groove, draw the hooked blade through the carpet. Hold the carpet flat and prevent from moving. Continue to cut a long length by sliding the whole section along the edge of the carpet. Make sure the carpet is touching the guide at both ends to prevent swivel or pivot at high spots.

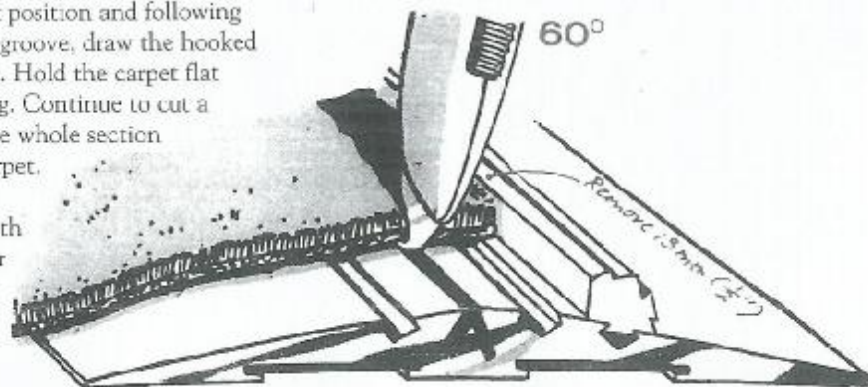

# The Durafit System

THE  
DURAFIT  
System

# The Durafit System

STEP TWO: \*Remove selvage cutter and replace base. Place the base section against the newly cut edge (the central plate will now overlay the carpet and the groove will line up with the new edge). The second piece of carpet to be cut will now lie over the central plate and can be cut by tilting the knife at an angle towards the first edge. Make sure the base stays firmly against the carpet underneath (i.e. the first cut edge). Simply move as required.

Hooked blade only should be used in order to avoid damage to the groove. Practice cutting at the correct angle and holding the knife fairly upright by cutting paper first.

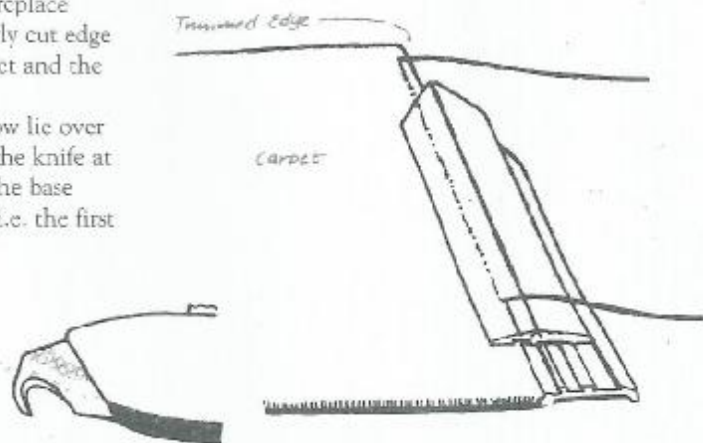

## BORDERS/MITRES, DOOR SEAMS, CROSS SEAMS

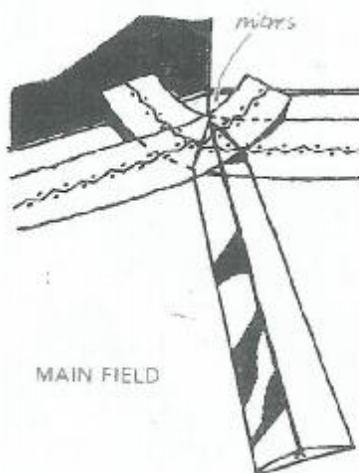

To mitre borders place the central plate (base and guide section removed) in the corner. Where the carpets cross over, move the tool into the correct position by lining the groove at the crossover point. The carpets are cut separately in opposing grooves.

Double sided tape may be used to assist in holding carpet flat on the tool, also to hold the tool in place. (Avoid getting the tape in the groove). If the walls are not true angles, you may have to compensate by moving the point of tool slightly left or right, but at all times the crossover point and the groove must be in line.

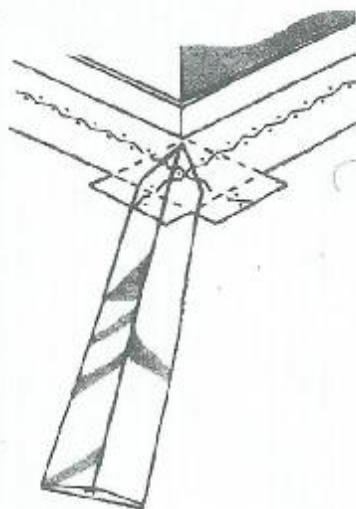

Outside mitres follow the same principles as inside mitres. Temporarily tack border in place. Lay out the field and stretch, temporarily tack into place. Replace base section onto central plate. Cut field to border by pressing base firmly against border and cutting surplus carpet using the knife at angle towards the border.

\* This is the same principal as doing the long join.

## SELVAGE REMOVAL

B and C positions are for removing selvage of different thicknesses. B will remove 2mm, C will remove 3mm. Simply slide selvage under the lip and ensure carpet does not move. Draw the knife (leaning the angle toward the guide) through the groove. After the first pass, continue to cut off selvage by lifting the piece already cut and lay it across the carpet. Where it is still joined on the wall, clearly show where to begin the second pass. Simply cut through the slight twist.

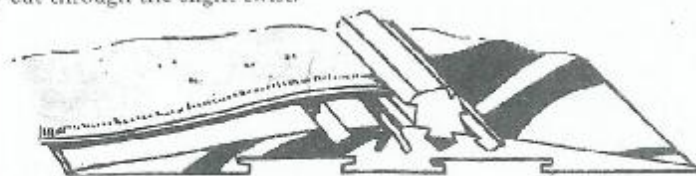

\*ALWAYS USE A HOOKED BLADE  
ALWAYS USE A SHARP BLADE  
ALWAYS HOLD CARPET FLAT  
ALWAYS FOLLOW THE ANGLE OF THE GROOVES  
\*NEVER HOLD YOUR HAND  
IN FRONT OF THE BLADE

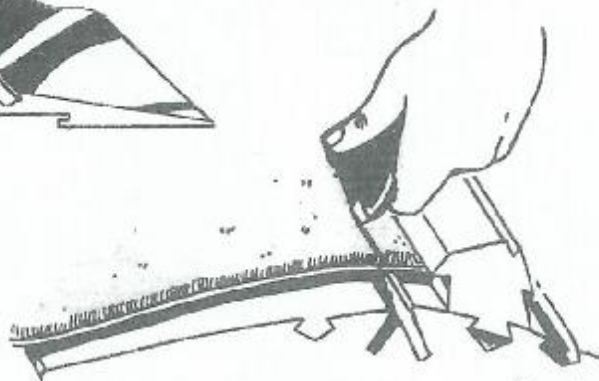

Duralay

