



Karndean
Designflooring



Beautiful flooring brings a home to life, adding warmth and texture, but choosing beautiful flooring doesn't have to be difficult. At **Karndean Designflooring** we make it easy to find the perfect floor to suit your unique style.

01386 820100 www.karndean.com

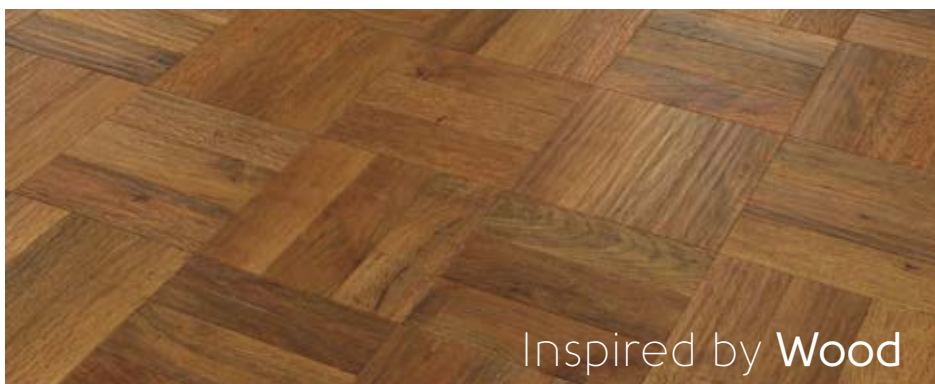



Karndean
Designflooring

Why Karndean?

Inspired by nature and designed for living, you'll find our floors are beautifully realistic and highly practical.

By offering a wide and impressive range of designs, finishes and formats, you can create a floor that's unique to your home and guaranteed to last for years to come.

Did you know?

Any Karndean floor purchased through one of our retailers comes with a transferable purchase guarantee.

So if you move home, the new owner will be covered for the remainder of the product's guarantee period.



Stylish



Quiet



Water resistant



Realistic



Durable

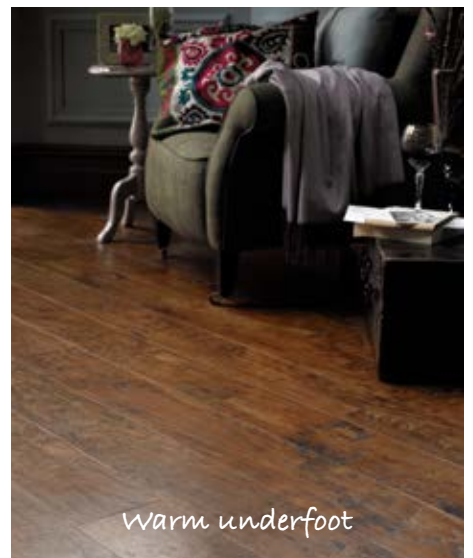

Warm underfoot



Hygienic



Low maintenance



Expertise

Designflooring: Take a closer look

We find the inspiration for Designflooring in the beauty of the natural world and feel passionate about bringing this into every product we create. From the intricate grain details in real woods to the timeless tactile qualities of natural stones, we've used the latest technology to bring you floors that are the ultimate in style and give you exceptionally high performance and quality. What's more, we've already chosen the best colours, formats and design components for each of our ranges, meaning it's easy to create the perfect design floor for your home.

Plank variation

Our planks are designed to reflect the variance and random character of natural materials, rather than looking uniform and manufactured.

wear layer

With a protective wear layer on each individual plank and tile, our floors are designed to withstand the everyday hustle and bustle of home life.

Do you love the authentic, rustic look of traditional crafted wood planks? Or perhaps you prefer the distinctive texture and intricate patterns of quarried stone? Whatever it is you're after, you're sure to find a look that's just right for you in our wide range of stylish, high quality Karndean Designfloors.

The right look for every room

We know that style is personal and every space is different. To help you find the right floor for your home, see what each of our ranges have to offer:

	Wood	Stone	
Art Select	✓	✓	Lovingly created to reflect the natural materials that inspired them. These planks and stones give you timeless craftsmanship at your feet. 20 year residential guarantee
Da Vinci	✓	✓	Smooth slender planks and richly textured tiles. Bevelled edges create distinct definition. 20 year residential guarantee
Michelangelo		✓	Make a statement with mosaics, metallics or soft contoured pebbles. Unique and character-packed surfaces. 15 year residential guarantee
Van Gogh	✓		The character of real timber in a wide range of designs including distressed, reclaimed and limed woods. 15 year residential guarantee
Opus	✓	✓	Fresh and contemporary. Available in larger plank and tile sizes. Simple lines and sleek design combine to create a clean, modern look. 15 year residential guarantee
Knight Tile	✓	✓	Our widest range of planks and tiles at our most affordable prices ensures there's something for everyone. 12 year residential guarantee
Karndean LooseLay	✓	✓	Our latest innovation. Quick and easy to fit over most existing hard floors. Quieter than laminate. 15 year residential guarantee



Did you know?

All of our products are compatible with underfloor heating systems.



Designflooring: Inspiration

How to create your perfect floor...

We have put together a quick guide to help you design your new floor. Your floor can be as simple or as intricate as you'd like. Follow the steps below to be on your way to creating a floor that's just as unique and individual as you are.

1 Choose a main colour and effect

We have an extensive range of colour tones in our **Inspired by Wood**, **Inspired by Stone** collections.

Inspired by Wood:

Choose from our wide selection of planks, each featuring realistic grain and knot details and textures. We offer a varied range of styles ideal to suit any room in your home.

See **Wood ranges at a glance** on pages 140-141



Inspired by Stone:

Choose from a palette of natural beiges and browns to cool blues and greens. With tiles including marble, slate, terracotta and ceramic effects plus our Michelangelo range of mosaics, pebbles and metallics.

See **Stone ranges at a glance** on pages 142-143



We offer a wide range of plank and tile sizes. To find out available sizes for your chosen product, please see the individual product pages.

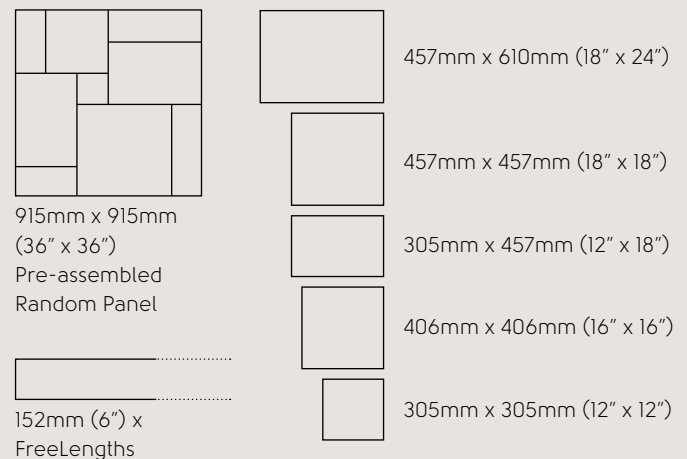
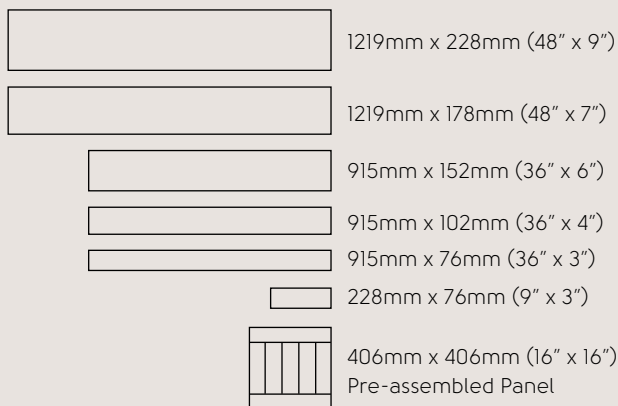

2 Add a design strip

Once you have chosen your main floor colour, you have the option of adding a decorative strip...

Inspired by Wood:

Add a strip between wood planks to create an attractive ship's decking effect.

Inspired by Stone:

We highly recommend adding a narrow strip to a tile floor to create a natural grouting effect.

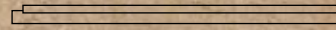
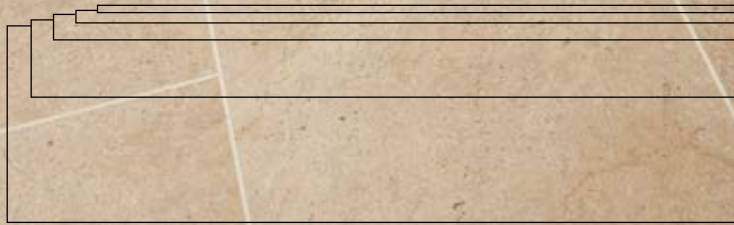

Grout Strips

Available in two widths:
3mm and 5mm
Six colours.
See page 113

Design and Metallic Strips

Available in five widths:
3mm, 5mm, 10mm, 30mm & 76mm
A wide palette of colours.
See pages 110-113

*Define your space and
get creative with strips*

3 Add a border

To personalise your floor even further or to help define your space, why not add a border?

Keyline Borders

Use single strips to define a space.
See pages 110-113

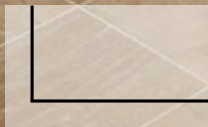

Tramline Borders

Use a combination of strips to create more emphasis.
See pages 110-113



Decorative Borders

Choose from a range of patterned borders designed specifically to complement your chosen floor.
See pages 114-119



4 Add a feature

With seven standard designs to choose from and the ability to design your own, a feature creates a focal point in your room. See pages 120-121

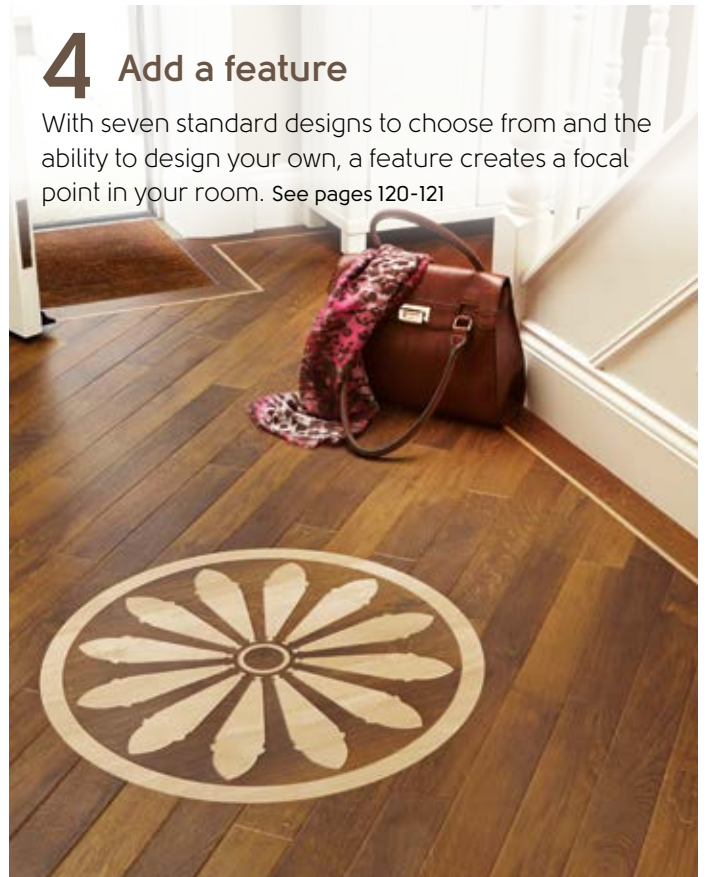





Karndean
Designflooring

Inspired by
Wood



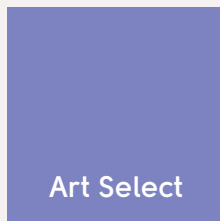

Art Select Woods

Full of charm and character, our premium Art Select Wood collection brings the natural beauty of real timber to life in your home.

Through meticulous attention to detail and careful selection of some of the most beautiful and inspiring natural timbers, our Art Select Wood collection includes our most intricate designs and realistic embosses. Each plank is handcrafted to reflect the unique grains, knots and textures of natural wood, but unlike real wood, we're able to design a floor that's not only beautiful and realistic, but is also practical.

Everything that a beautiful wood floor should be, and so much more, each of our Art Select Woods tells its own story.

20 year guarantee: residential use

Parquet page 15

Oak Royale page 19

Oak Premier page 22

Handcrafted page 25



We've taken classic parquet and crafted a collection that will transform any room in your home with our most detailed and elegant oak designs.

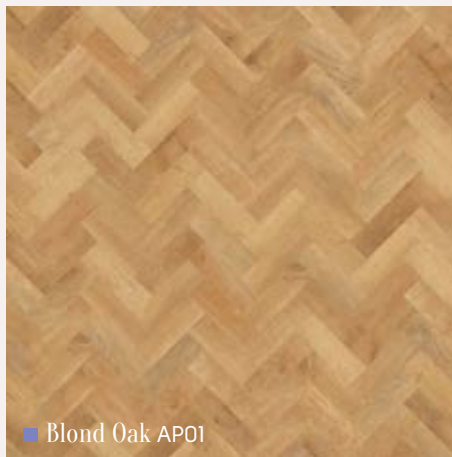

■ Blond Oak AP01

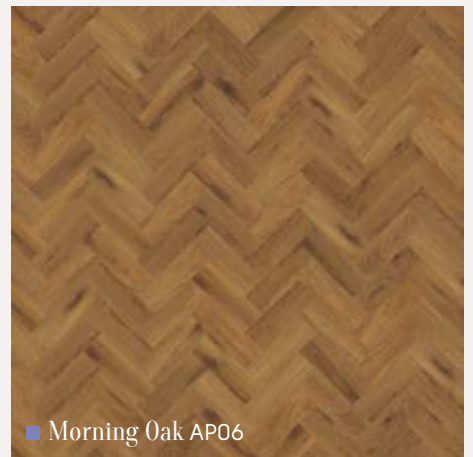

■ Morning Oak AP06

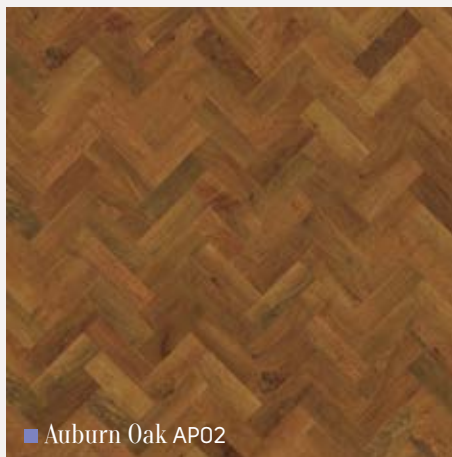

■ Auburn Oak AP02



■ Spanish Cherry AP05

Art Select Parquet

228mm x 76mm (9" x 3") Please see page 8 for size comparison guide

Find your nearest retailer at www.karndean.com/FAR or call 01386 820100



Herringbone: Look to the striking diagonals of this design to give a real sense of style in any space.



AP03 ▾



■ Sundown Oak AP04
228mm x 76mm (9" x 3")

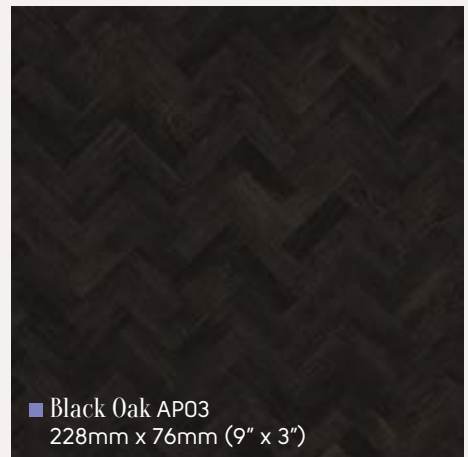

■ Black Oak AP03
228mm x 76mm (9" x 3")

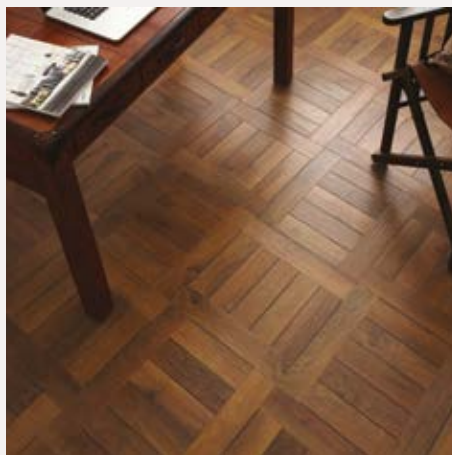

AP31 ▾

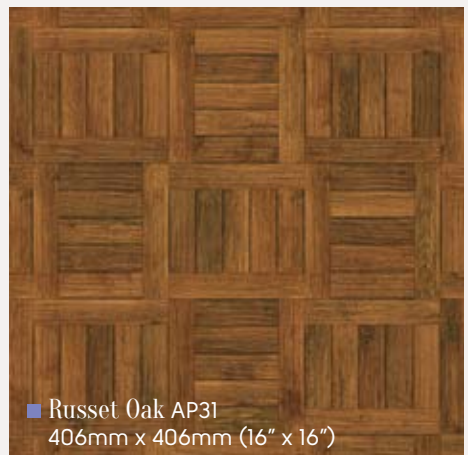

■ Russet Oak AP31
406mm x 406mm (16" x 16")

Art Select Parquet

Please see page 8 for size comparison guide

Find your nearest retailer at www.karndean.com/FAR or call 01386 820100







RL02 ▽



RL02 ▽



■ Spring Oak RL01



■ Summer Oak RL02



RL01 ▽

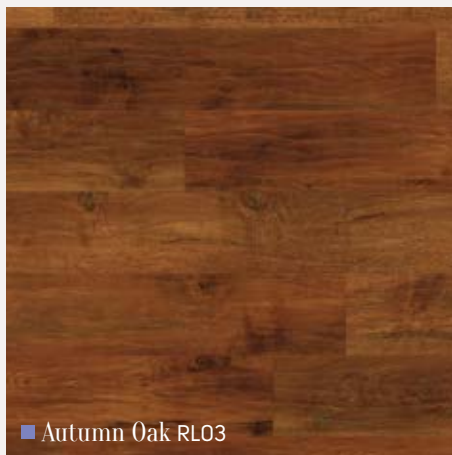

■ Autumn Oak RL03



■ Winter Oak RL04

Art Select Oak Royale

1219mm x 178mm (48" x 7") Please see page 8 for size comparison guide

Find your nearest retailer at www.karndean.com/FAR or call 01386 820100





RL07 ▽

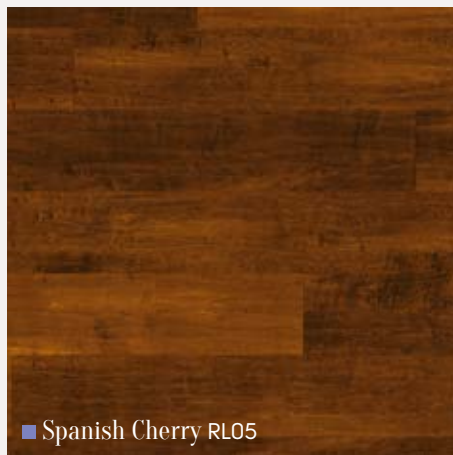
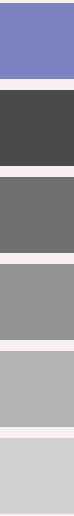

■ Spanish Cherry RL05



■ Santina Cherry RL07

Art Select Oak Royale

1219mm x 178mm (48" x 7") Please see page 8 for size comparison guide

Find your nearest retailer at www.karndean.com/FAR or call 01386 820100



HC02 Δ

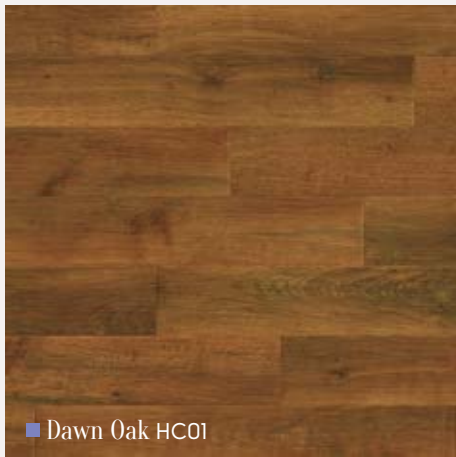

■ Dawn Oak HC01

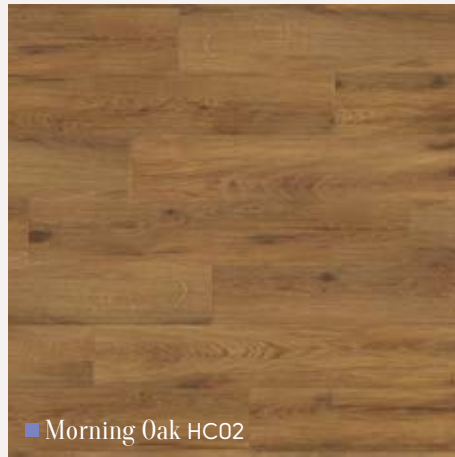

■ Morning Oak HC02



■ Dusk Oak HC03

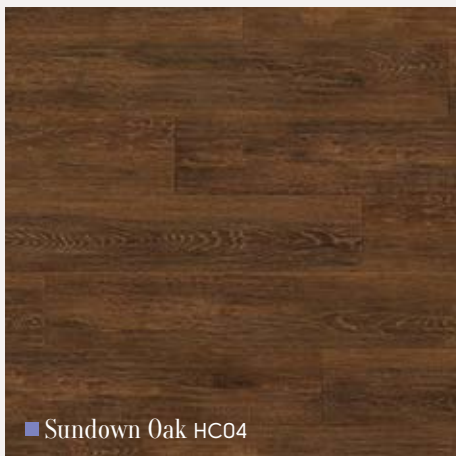

■ Sundown Oak HC04

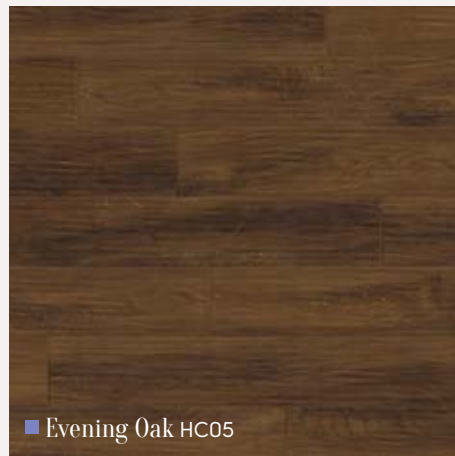

■ Evening Oak HC05



■ Midnight Oak HC06

Art Select Oak Premier

915mm x 152mm (36" x 6") Please see page 8 for size comparison guide

Find your nearest retailer at www.karndean.com/FAR or call 01386 820100







EW01 ▽



Handcrafted: Designed by hand to perfectly reflect the natural grains, knots and textures of real timber.

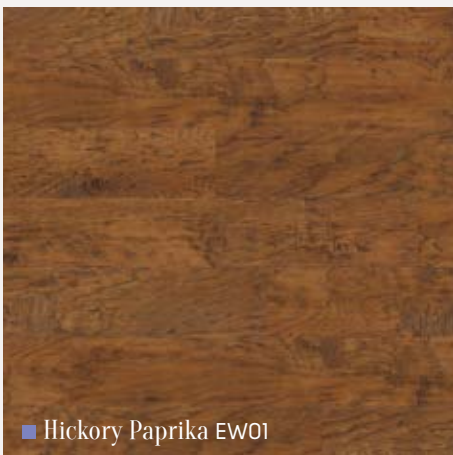

■ Hickory Paprika EW01

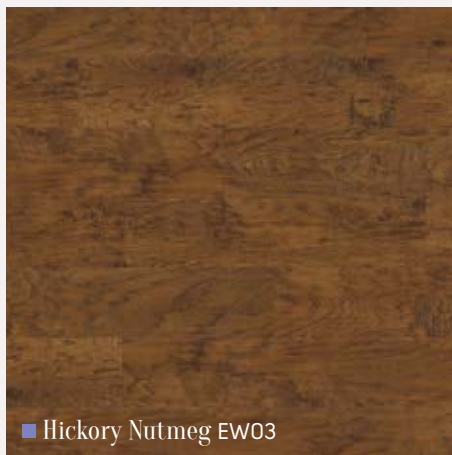

■ Hickory Nutmeg EW03



■ Hickory Peppercorn EW02

Art Select Handcrafted

915mm x 152mm (36" x 6") Please see page 8 for size comparison guide

Find your nearest retailer at www.karndean.com/FAR or call 01386 820100





*Warm and inviting with
a timeless classic feel*

RP73 Δ



Slender 3" planks

RP61 Δ



Distinctive bevelling

RP93 Δ

Da Vinci

Da Vinci Wood

20 year guarantee: residential use

Each of our Da Vinci planks feature a distinctive bevelled edge and light surface finish, creating a traditional and elegant look.

With a wide range of colours and designs, from the pale tones of American Oak to the richness of Australian Walnut, there's something to suit any decor.

Light wood page 29

Mid wood page 30

Dark wood page 33



Personalise your floor by using different laying patterns, such as the herringbone design shown here



RP11 ▽



RP11 ▽

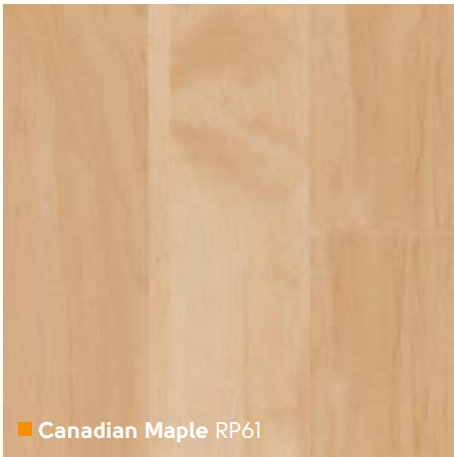

Canadian Maple RP61



American Oak RP11

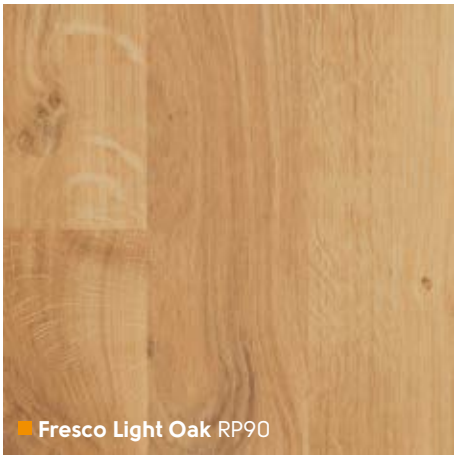

Fresco Light Oak RP90



English Elm RP51

Da Vinci Light Wood

915mm x 76mm (36" x 3") Please see page 8 for size comparison guide

Find your nearest retailer at www.karndean.com/FAR or call 01386 820100



Mid toned woods add warmth to any room

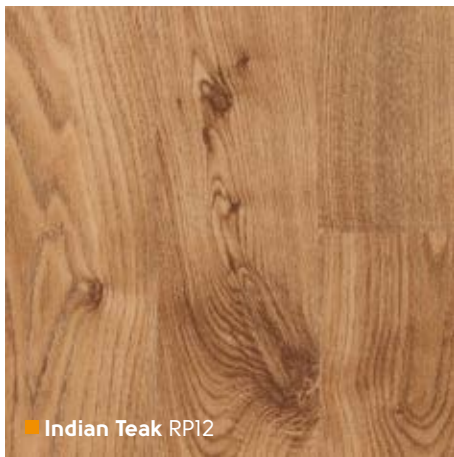

■ Indian Teak RP12

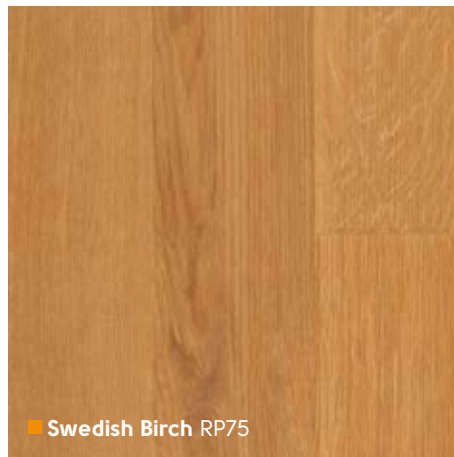

■ Swedish Birch RP75



■ Kenyan Tigerwood RP73

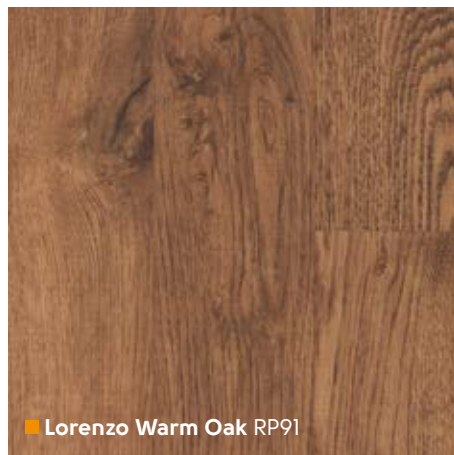

■ Lorenzo Warm Oak RP91



Da Vinci Mid Wood

915mm x 76mm (36" x 3") Please see page 8 for size comparison guide

Find your nearest retailer at www.karndean.com/FAR or call 01386 820100





RP93 ▾

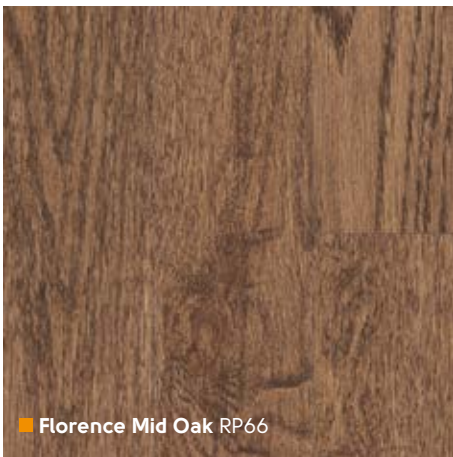

■ Florence Mid Oak RP66

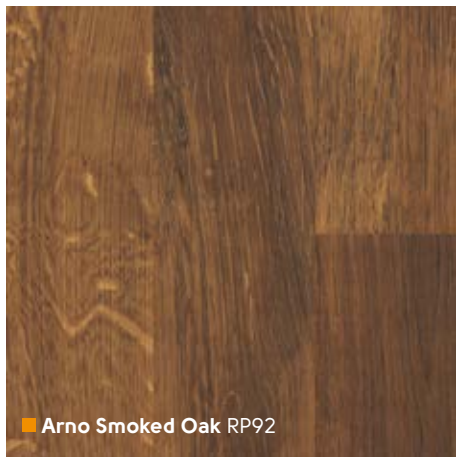

■ Arno Smoked Oak RP92

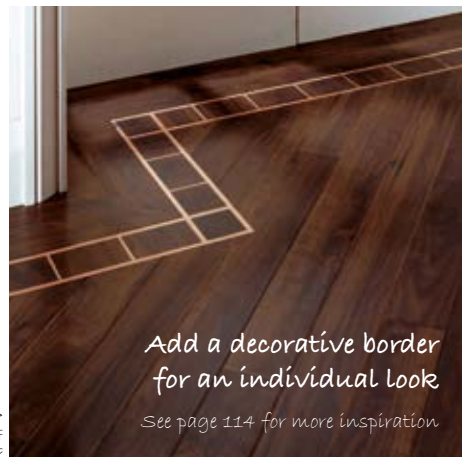

RP41 ▾

*Add a decorative border
for an individual look
See page 114 for more inspiration*

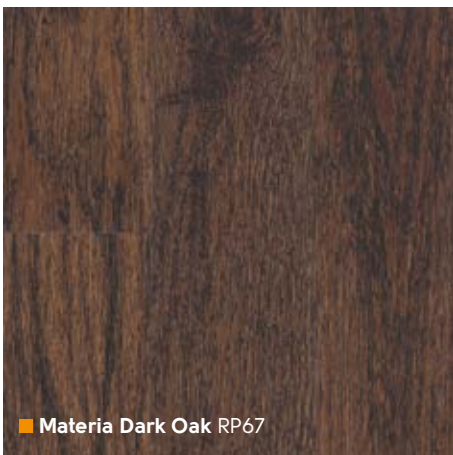

■ Materia Dark Oak RP67

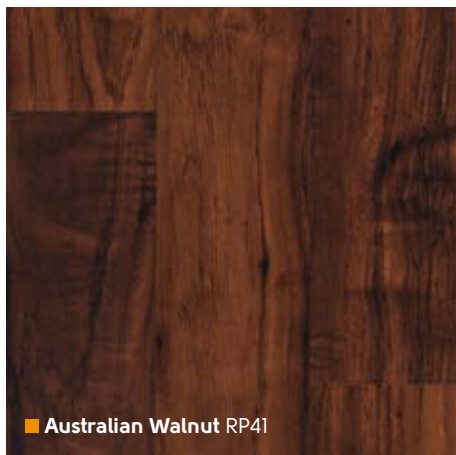

■ Australian Walnut RP41

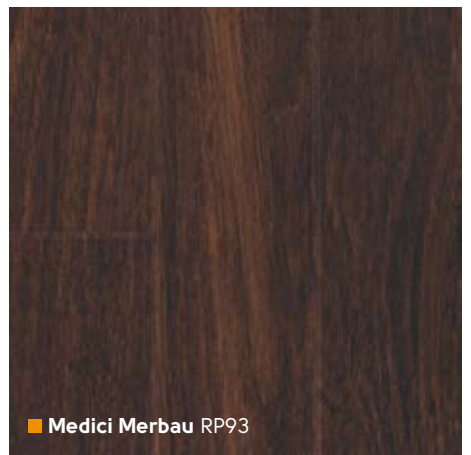

■ Medici Merbau RP93

Da Vinci Dark Wood

915mm x 76mm (36" x 3") Please see page 8 for size comparison guide

Find your nearest retailer at www.karndean.com/FAR or call 01386 820100





warm and inviting

VGW861 Δ



Subtle texture

VGW87 Δ



Large planks

VGW841 Δ

Van Gogh

Van Gogh Wood

15 year guarantee: residential use

Our popular Van Gogh collection captures the look of real timber in a variety of colours and designs from traditional rustic to cool contemporary. Large planks, distinctive grain details and a subtle texture create a style that works in any space.

Light wood page 37

Mid wood page 39

Dark wood page 43

*Change the angle of your
planks to create open plan
spaces with definition*





VGW84T ▽

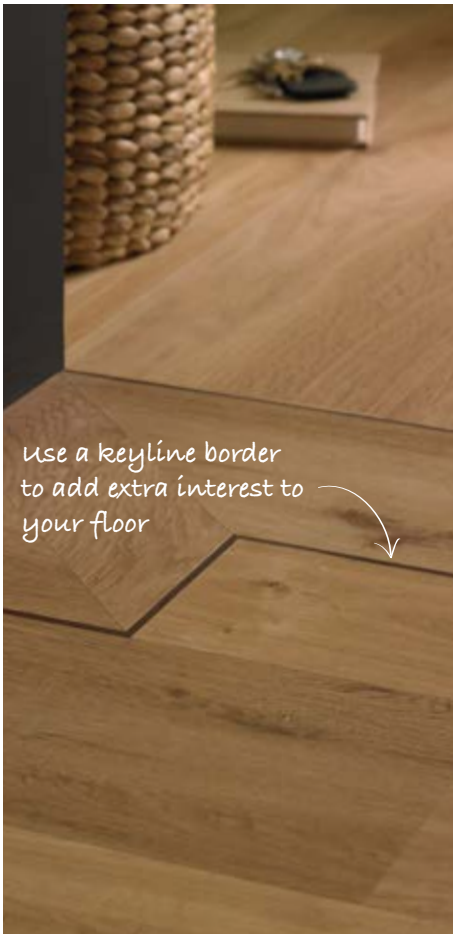

Use a keyline border to add extra interest to your floor



VGW85T ▽



White Washed Oak VGW80T



Birch VGW84T

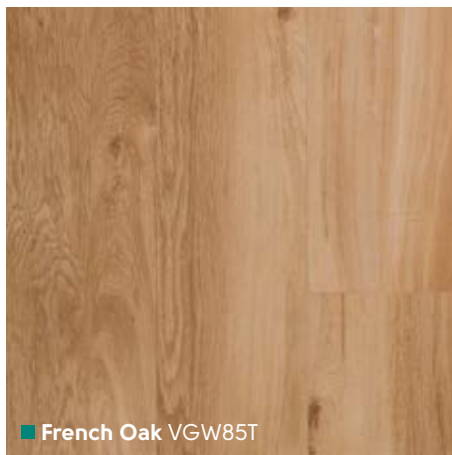

French Oak VGW85T



Macrocapra VGW50T

Van Gogh Light Wood

1219mm x 178mm (48" x 7") Please see page 8 for size comparison guide

Find your nearest retailer at www.karndean.com/FAR or call 01386 820100



VGW81T ▾



Blue and purple hues are a perfect match for our rustic Country Oak planks



■ Distressed Oak VGW82T



■ Country Oak VGW81T



■ Frosted Birch VGW83T



■ Auckland Oak VGW52T

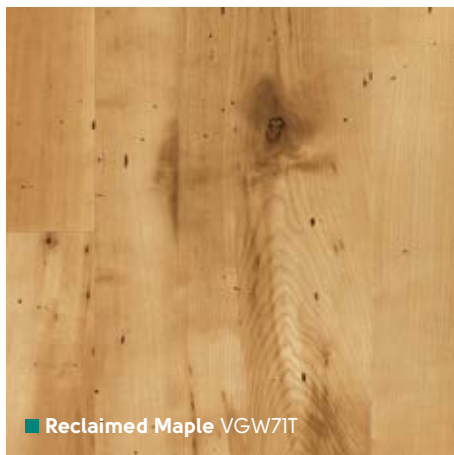

■ Reclaimed Maple VGW71T



■ Wellington Oak VGW53T

Van Gogh Mid Wood

1219mm x 178mm (48" x 7") Please see page 8 for size comparison guide

Find your nearest retailer at www.karndean.com/FAR or call 01386 820100



VG5-7 ▽

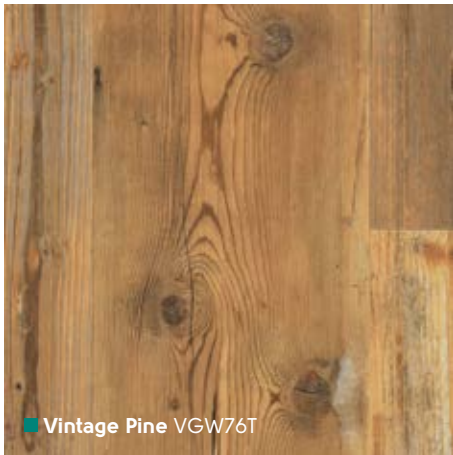

■ Vintage Pine VGW76T

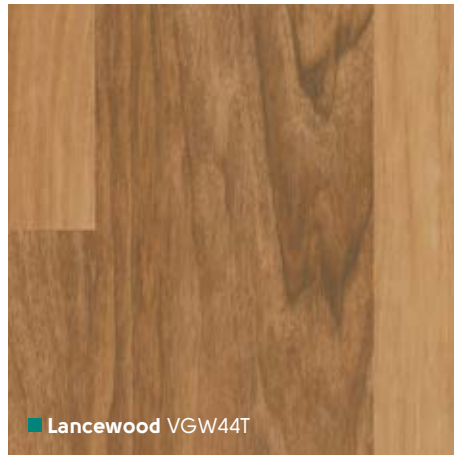

■ Lancewood VGW44T



■ Classic Oak VGW86T

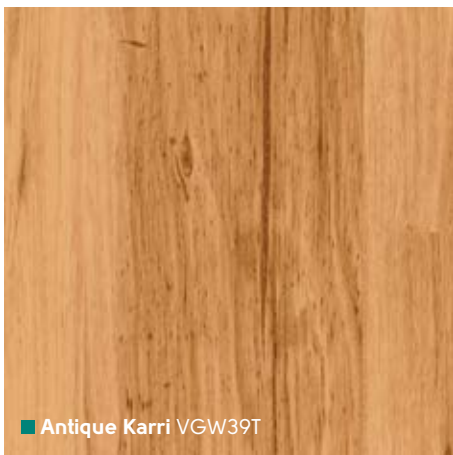

■ Antique Karri VGW39T

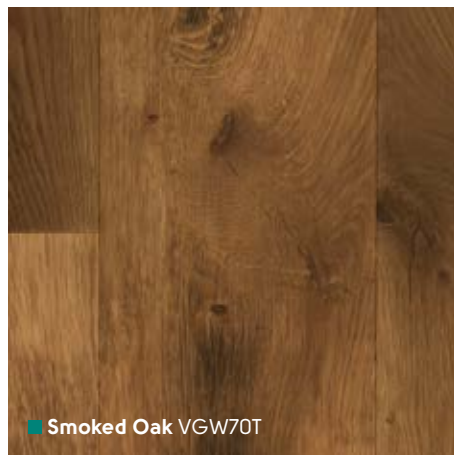

■ Smoked Oak VGW70T

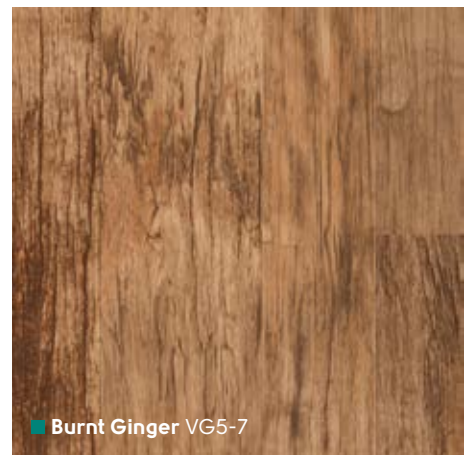

■ Burnt Ginger VG5-7

Van Gogh Mid Wood

1219mm x 178mm (48" x 7") Please see page 8 for size comparison guide

Find your nearest retailer at www.karndean.com/FAR or call 01386 820100



BOCKER
GLORY
BREAD & BUTTER PUDDING







VGW87T ▾

Dark woods can give a sophisticated feel



VGW89T ▾



■ Aged Kauri VGW51T

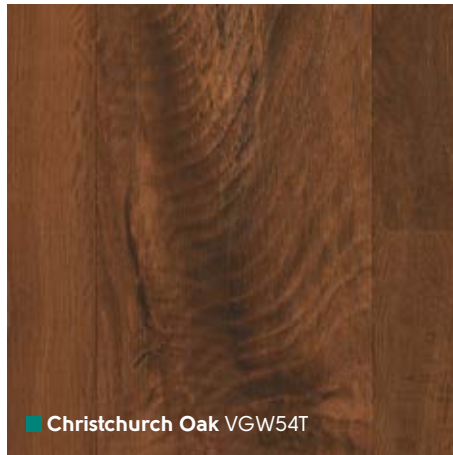

■ Christchurch Oak VGW54T



■ Bracken VG1-7

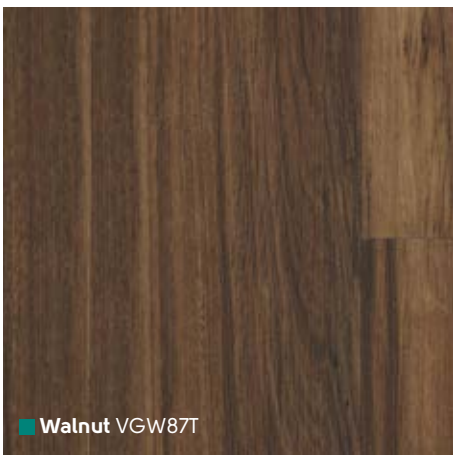

■ Walnut VGW87T

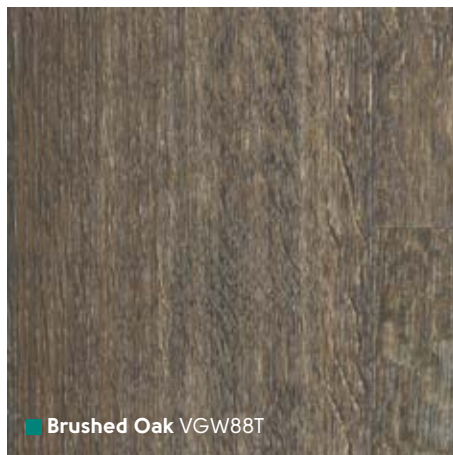

■ Brushed Oak VGW88T

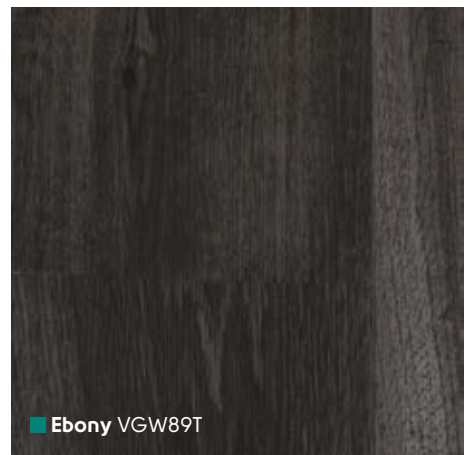

■ Ebony VGW89T

Van Gogh Dark Wood

1219mm x 178mm (48" x 7") Please see page 8 for size comparison guide

Find your nearest retailer at www.karndean.com/FAR or call 01386 820100





Fresh and
contemporary

WP311 Δ



Mix of surface finishes

WP313 Δ



Large plank sizes

WP414 Δ

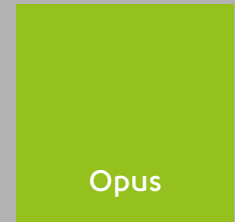

Opus Wood

15 year guarantee: residential use

Our Opus collection brings you a fresh, modern feel in some of our largest plank sizes. The wide range of tones and mix of surface finishes combined with clean lines means you can achieve a sense of simplicity and visual space whatever your colour scheme.

Light wood page 47

Mid wood page 48

Dark wood page 51







WP311 ▾

Create an airy, contemporary look by teaming cool light woods with vibrant colours



WP411 ▾



■ **Palleo** WP312
915mm x 152mm (36" x 6")

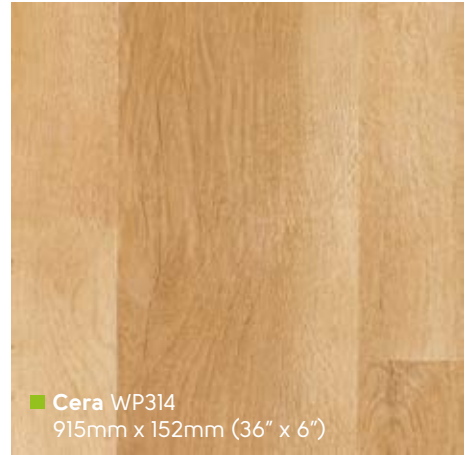

■ **Cera** WP314
915mm x 152mm (36" x 6")



■ **Grano** WP311
915mm x 152mm (36" x 6")



■ **Niveus** WP411
1219mm x 228mm (48" x 9")

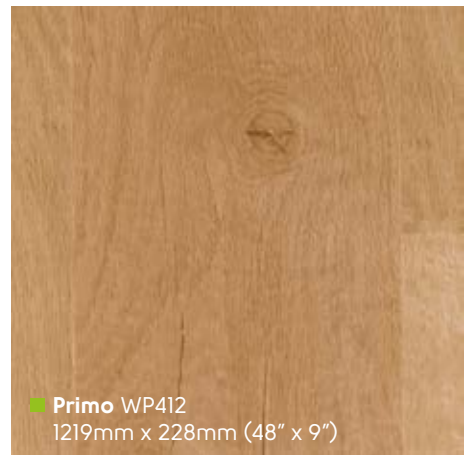

■ **Primo** WP412
1219mm x 228mm (48" x 9")

Opus Light Wood

Please see page 8 for size comparison guide

Find your nearest retailer at www.karndean.com/FAR or call 01386 820100



The character of aged timber can really add to any style of room

WP313 ▽

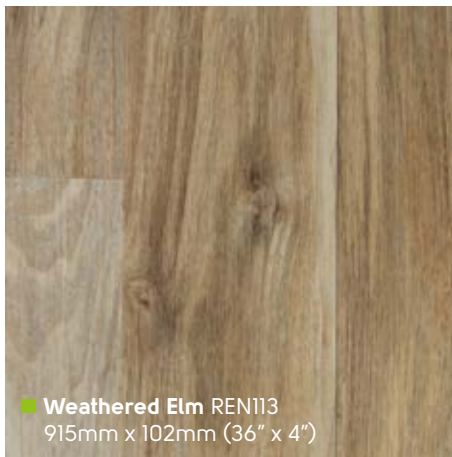

■ **Weathered Elm** REN113
915mm x 102mm (36" x 4")

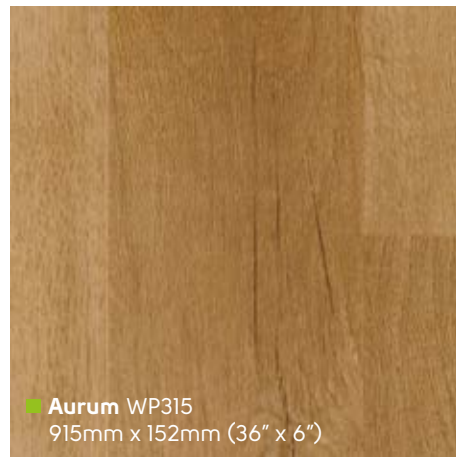

■ **Aurum** WP315
915mm x 152mm (36" x 6")

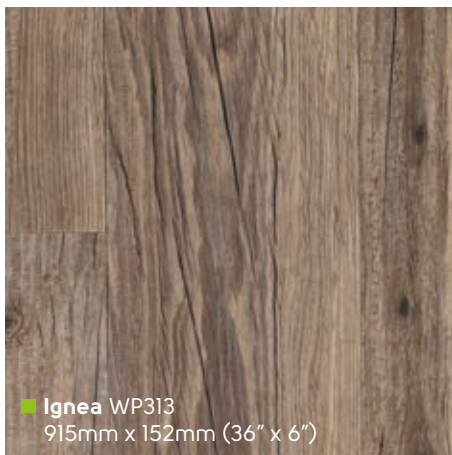

■ **Ignea** WP313
915mm x 152mm (36" x 6")

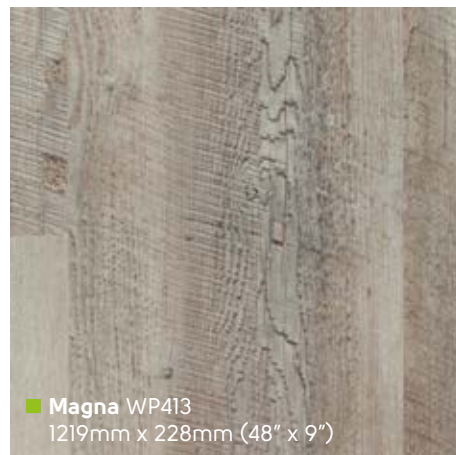

■ **Magna** WP413
1219mm x 228mm (48" x 9")



Opus Mid Wood

Please see page 8 for size comparison guide

Find your nearest retailer at www.karndean.com/FAR or call 01386 820100







Add a simple and smart tranline border to create a sophisticated look

WP414

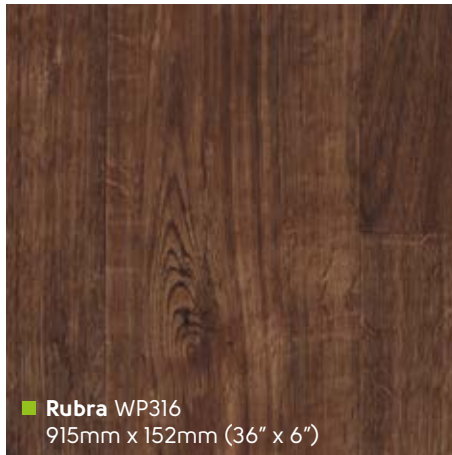

■ **Rubra** WP316
915mm x 152mm (36" x 6")



■ **Atra** WP317
915mm x 152mm (36" x 6")

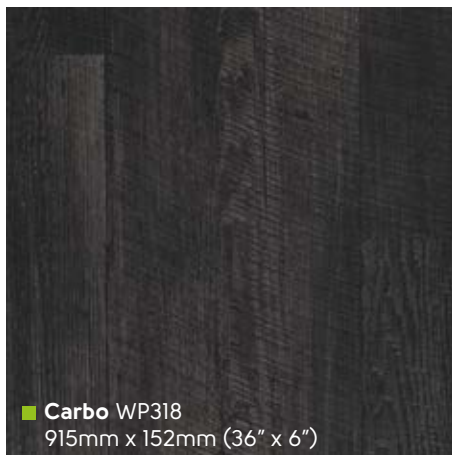

■ **Carbo** WP318
915mm x 152mm (36" x 6")



■ **Argen** WP414
1219mm x 228mm (48" x 9")

Opus Dark Wood

Please see page 8 for size comparison guide

Find your nearest retailer at www.karndean.com/FAR or call 01386 820100





Wide selection

KP94 Δ



*Works wonderfully
throughout your home*

KP91 Δ



*Knot and grain detail
on every plank*

KP92 Δ

Knight Tile

Knight Tile Wood

12 year guarantee: residential use

Our Knight Tile woods collection offers our widest range of planks at our most affordable prices, ensuring there's something for everyone. Choose from a variety of design strips and borders to personalise your space.

Light wood page 55

Mid wood page 56

Dark wood page 61





KP94 ▽

KP94 ▽



■ **White Painted Oak** KP105
915mm x 152mm (36" x 6")

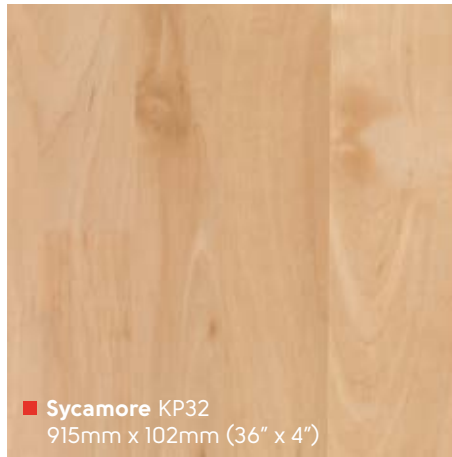

■ **Sycamore** KP32
915mm x 102mm (36" x 4")

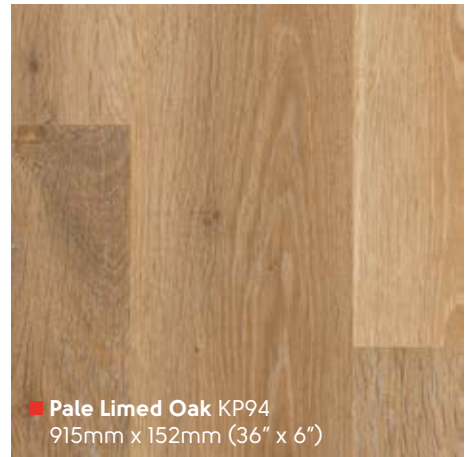

■ **Pale Limed Oak** KP94
915mm x 152mm (36" x 6")



■ **Arctic Driftwood** KP51
915mm x 102mm (36" x 4")

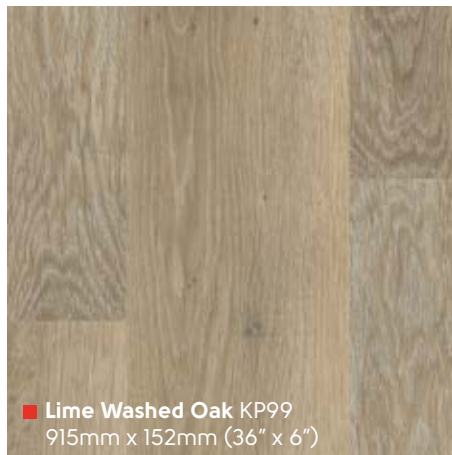

■ **Lime Washed Oak** KP99
915mm x 152mm (36" x 6")

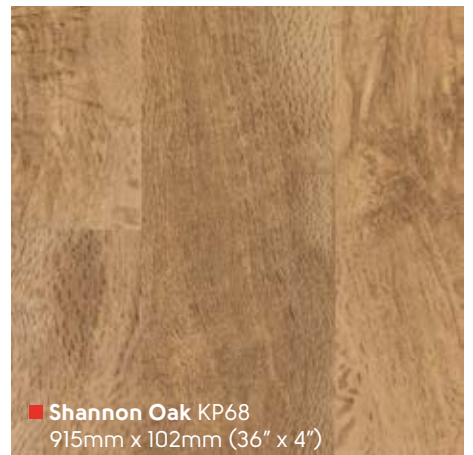

■ **Shannon Oak** KP68
915mm x 102mm (36" x 4")

Knight Tile Light Wood

Please see page 8 for size comparison guide

Find your nearest retailer at www.karndean.com/FAR or call 01386 820100

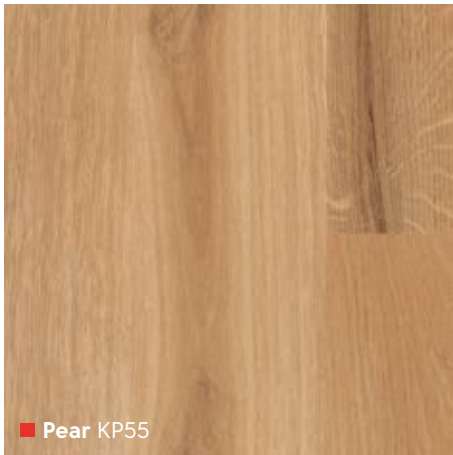

■ Pear KP55



■ American Oak KP40

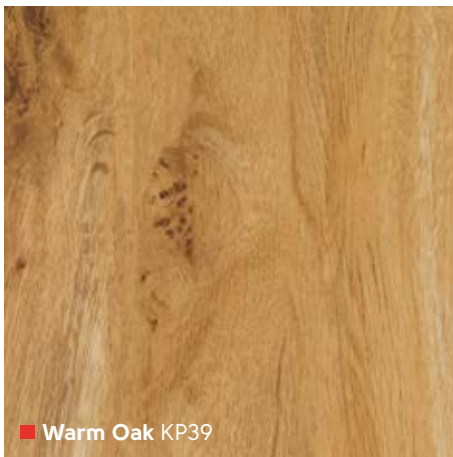

■ Warm Oak KP39

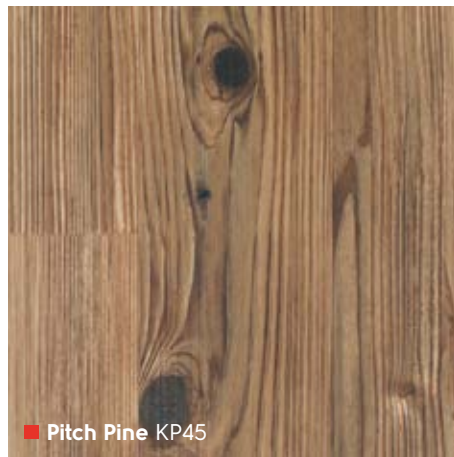

■ Pitch Pine KP45

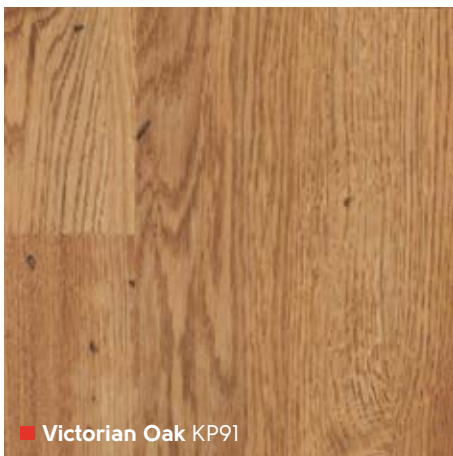

■ Victorian Oak KP91

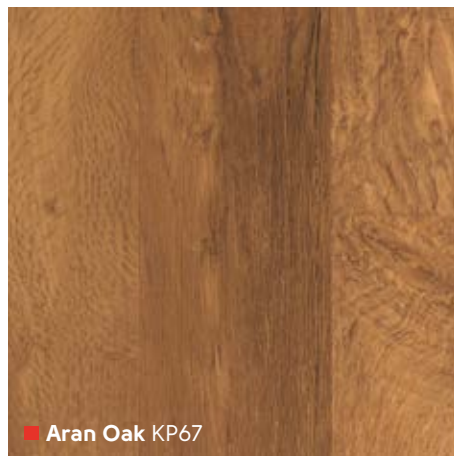

■ Aran Oak KP67



Knight Tile Mid Wood

915mm x 102mm (36" x 4") Please see page 8 for size comparison guide

Find your nearest retailer at www.karndean.com/FAR or call 01386 820100

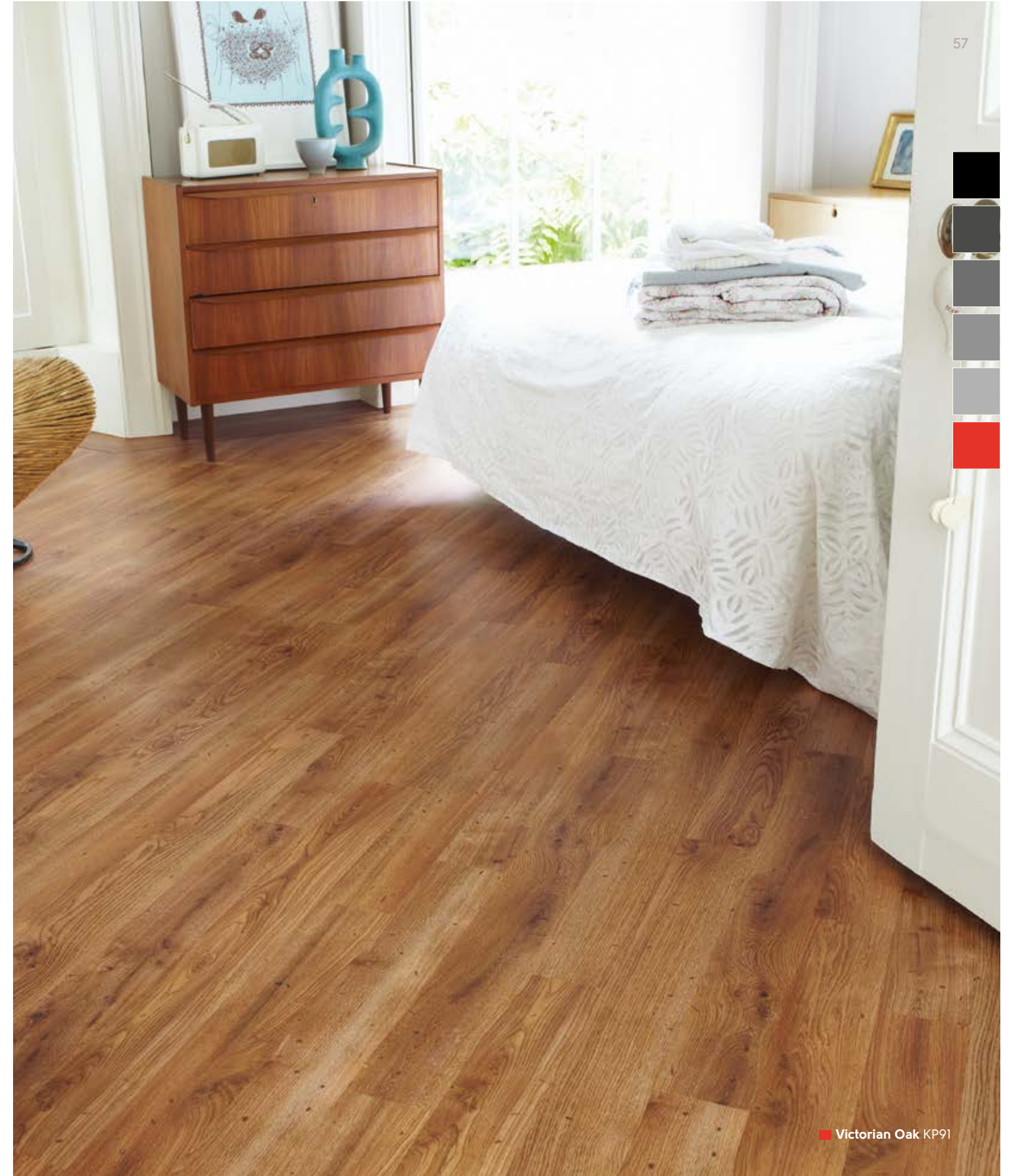



Mid-toned woods and white walls work well as a neutral base to showcase your personal style



Go for chalky pastels and vintage accessories to give your space a trendy retro chic look

KP96 ▽



KP102 ▽

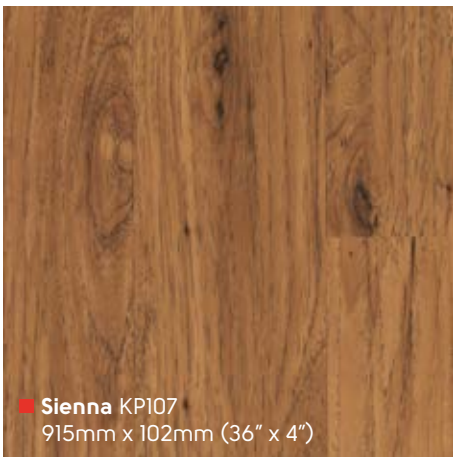

■ **Sienna KP107**
915mm x 102mm (36" x 4")

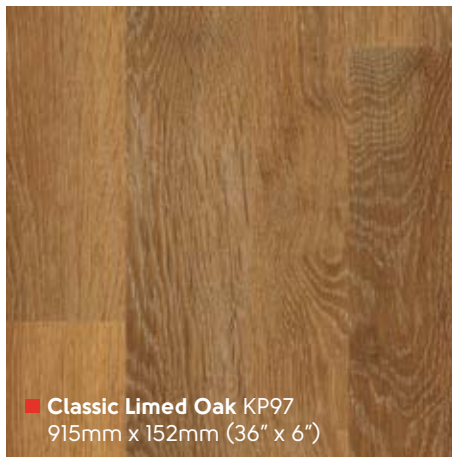

■ **Classic Lined Oak KP97**
915mm x 152mm (36" x 6")

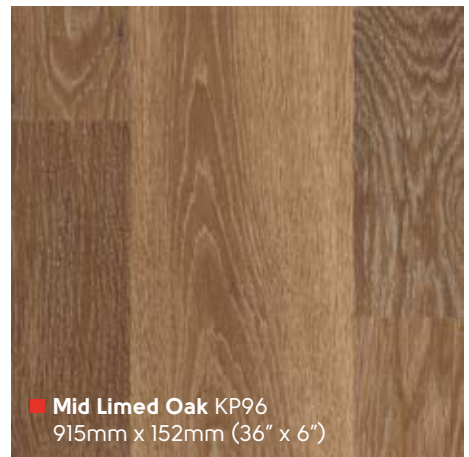

■ **Mid Lined Oak KP96**
915mm x 152mm (36" x 6")

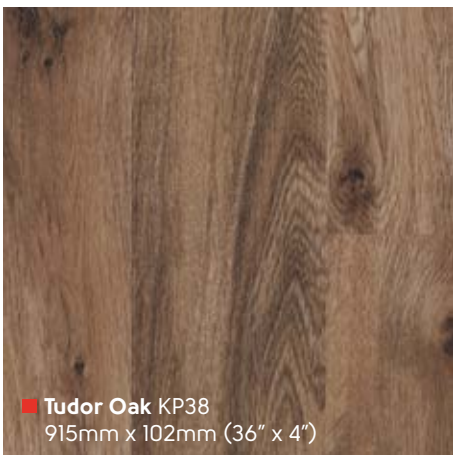

■ **Tudor Oak KP38**
915mm x 102mm (36" x 4")

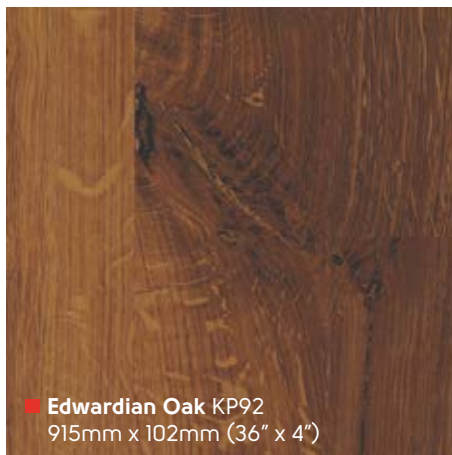

■ **Edwardian Oak KP92**
915mm x 102mm (36" x 4")

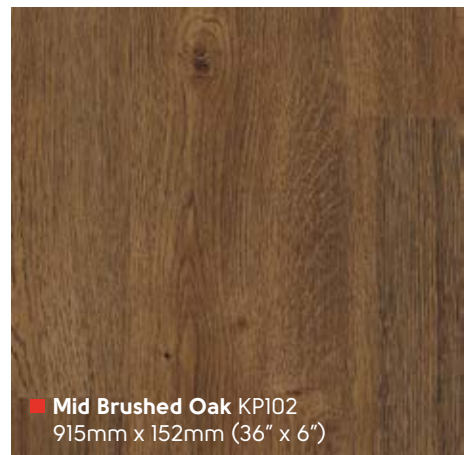

■ **Mid Brushed Oak KP102**
915mm x 152mm (36" x 6")

Knight Tile Mid Wood

Please see page 8 for size comparison guide

Find your nearest retailer at www.karndean.com/FAR or call 01386 820100





KP103 ▽



■ **Caribbean Driftwood KP52**
915mm x 102mm (36" x 4")

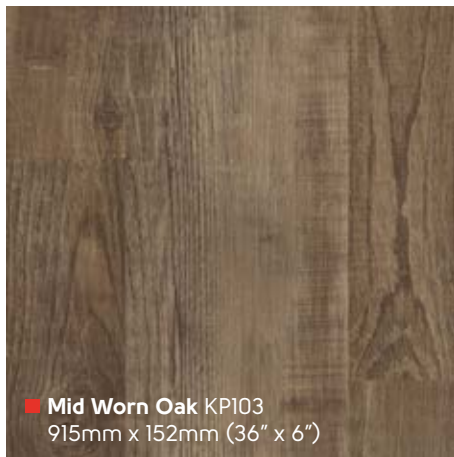

■ **Mid Worn Oak KP103**
915mm x 152mm (36" x 6")

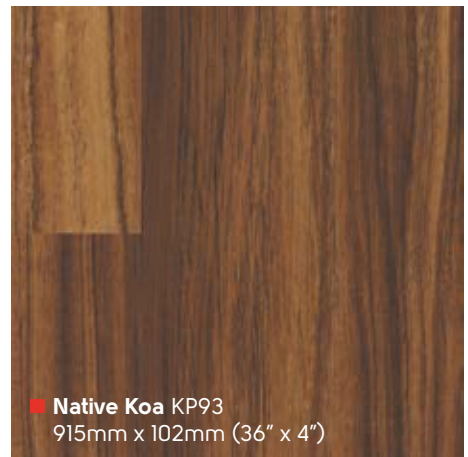

■ **Native Koa KP93**
915mm x 102mm (36" x 4")



KP98 ▽

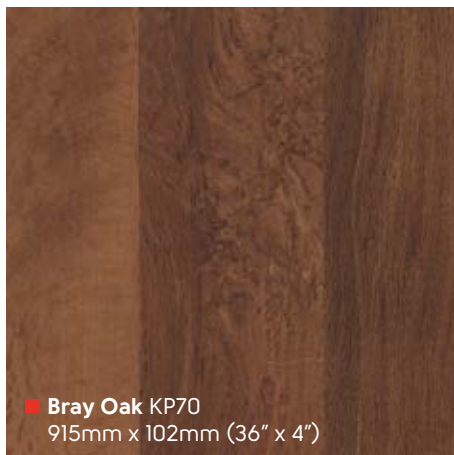

■ **Bray Oak KP70**
915mm x 102mm (36" x 4")

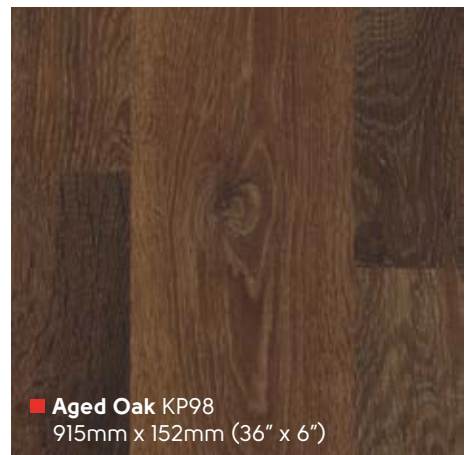

■ **Aged Oak KP98**
915mm x 152mm (36" x 6")

Knight Tile Dark Wood

Please see page 8 for size comparison guide

Find your nearest retailer at www.karndean.com/FAR or call 01386 820100





Karndean
Designflooring

Inspired by
Stone



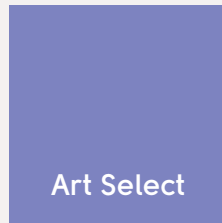

Art Select Stones

Effortlessly stylish and one of a kind, our premium Art Select Stone collection brings the natural beauty of travertine, slate, marble and limestone to life in your home.

Expect our most authentic designs and realistic embosses, handcrafted to reflect the unique patterns and textures of real stone.

Precious and individual, each of our Art Select Stones tells its own story.

20 year guarantee: residential use

Travertine page 67

Slate page 70

Marble page 73

Limestone page 75



■ Washburn LM07 with DS10 3mm design strip



FreeLengths: Available in the same decadent tones as our full tiles, these stones are each six inches wide, but in varying lengths.

LM17 ▽

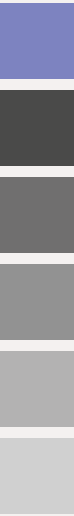

LM07 and LM17 ▽



■ Washburn LM07
457mm x 610mm (18" x 24")



■ Washburn LM17
152mm (6") x FreeLengths

Art Select Travertine

Our FreeLength stones are 6" wide in varying lengths. Please see page 8 for size comparison guide

Find your nearest retailer at www.karndean.com/FAR or call 01386 820100



For a truly unique look, lay our full size travertine tiles running into FreeLengths to create a stunning 'room to room' design.



LM05 ▽



LM08 ▽

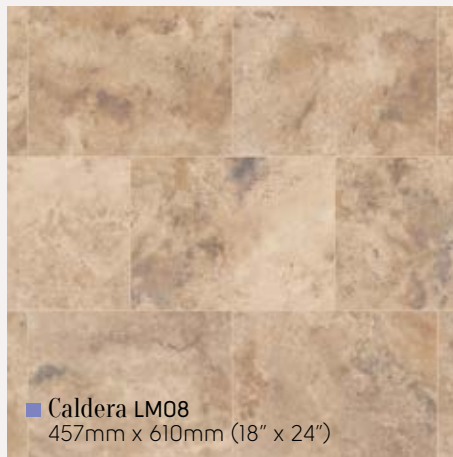

■ Caldera LM08
457mm x 610mm (18" x 24")



■ Gallatin LM09
457mm x 610mm (18" x 24")



■ Caldera LM18
152mm (6") x FreeLengths



■ Gallatin LM19
152mm (6") x FreeLengths

Art Select Travertine

Our FreeLength stones are 6" wide in varying lengths. Please see page 8 for size comparison guide

Find your nearest retailer at www.karndean.com/FAR or call 01386 820100

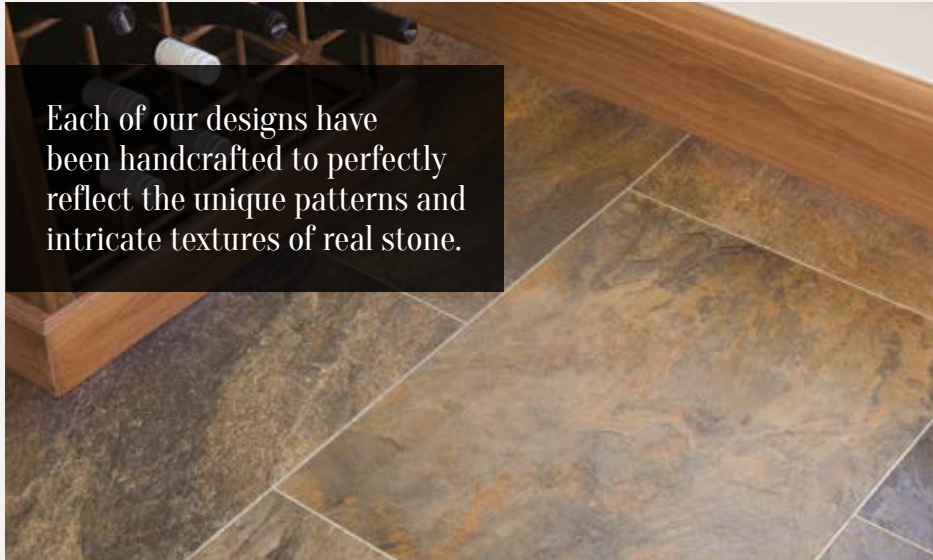

Each of our designs have been handcrafted to perfectly reflect the unique patterns and intricate textures of real stone.

LM05 ▾

Parliament Slates



■ Melbourne LM05
457mm x 610mm (18" x 24")



■ Canberra LM06
457mm x 610mm (18" x 24")

Welsh Slates



■ Corris LM12
915mm x 915mm (36" x 36")*



■ Oakeley LM11
915mm x 915mm (36" x 36")*



Art Select Slate

*A pre-assembled panel of 9 assorted tiles with design strip and offsetting tiles to create a random look
Please see page 8 for size comparison guide

Find your nearest retailer at www.karndean.com/FAR or call **01386 820100**



■ Canberra LM06 with DS15 3mm design strip



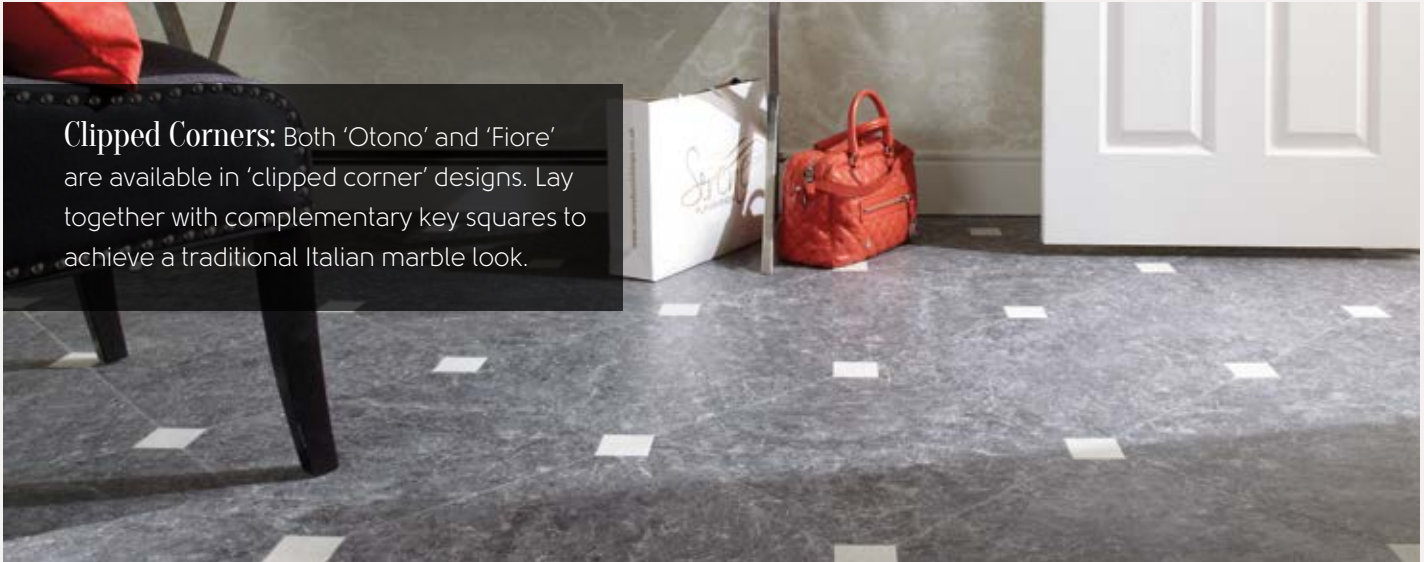

Clipped Corners: Both 'Otono' and 'Fiore' are available in 'clipped corner' designs. Lay together with complementary key squares to achieve a traditional Italian marble look.

LM15-Clip ▾



Italian Marbles



■ Otono LM15
406mm x 406mm (16" x 16")

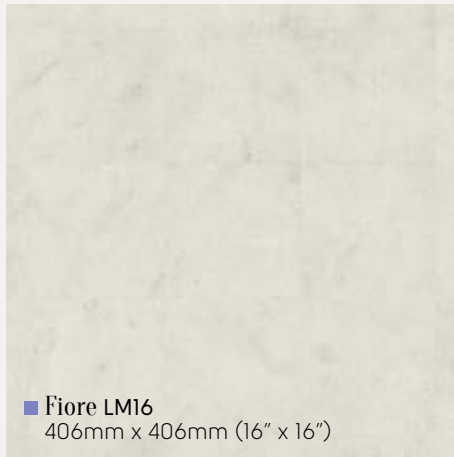

■ Fiore LM16
406mm x 406mm (16" x 16")

Ashford Marble



■ Ashford LM10
915mm x 915mm (36" x 36")*



■ Otono LM15-Clip
406mm x 406mm (16" x 16")



■ Fiore LM16-Clip
406mm x 406mm (16" x 16")



LM16 ▾

Art Select Marble

*A pre-assembled panel of 9 assorted tiles with design strip and offsetting tiles to create a random look
Please see page 8 for size comparison guide

Find your nearest retailer at www.karndean.com/FAR or call 01386 820100





LM20 ▽



■ Alderney LM03



■ Jersey LM01



■ Guernsey LM02



■ Herm LM20

Art Select Limestone

915mm x 915mm (36" x 36")* Please see page 8 for size comparison guide

*A pre-assembled panel of 9 assorted tiles with design strip and offsetting tiles to create a random look

Find your nearest retailer at www.karndean.com/FAR or call 01386 820100





Distinctive bevelling

M45-12 Δ

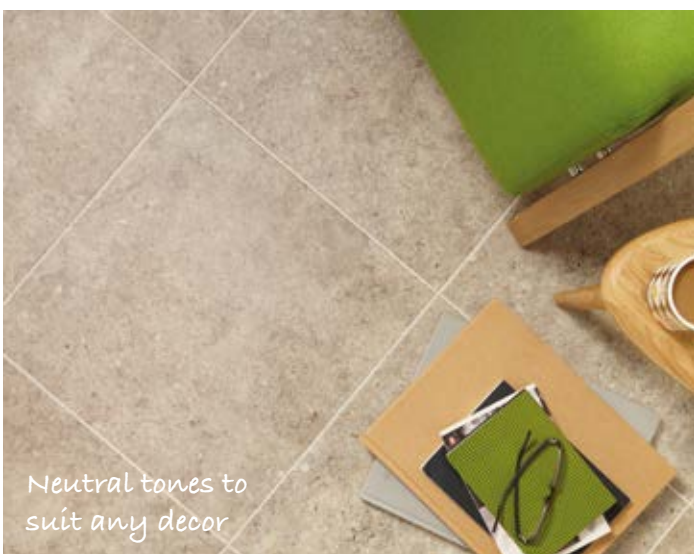

Neutral tones to suit any decor

L1T04 Δ



Design elements to complement your floor

CK21 Δ

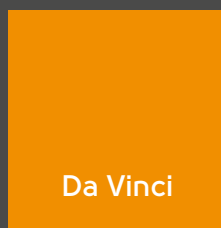

Da Vinci

Da Vinci Stone

20 year guarantee: residential use

Our Da Vinci collection offers the rich textures of natural stone, slate and ceramic, with a comforting warmth unique to Karndean Designflooring. The angled edges add definition to each tile and a range of design strips enables you to choose a finishing touch to complete your look.



Light stone page 79

Mid stone page 82

Dark stone page 85





△ 101ST

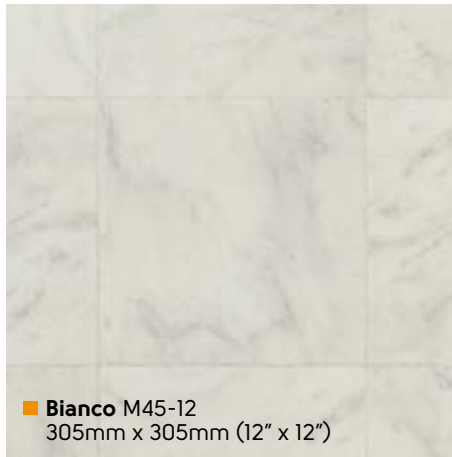

■ **Bianco M45-12**
305mm x 305mm (12" x 12")



■ **Limestone LST01**
406mm x 406mm (16" x 16")



■ **Latte CK23**
406mm x 406mm (16" x 16")



■ **Sienna Limestone LST02**
406mm x 406mm (16" x 16")

Da Vinci Light Stone

Please see page 8 for size comparison guide

Find your nearest retailer at www.karndean.com/FAR or call 01386 820100





LST03 ▽



■ Alabaster CC04
406mm x 406mm (16" x 16")



■ Cotswold SS6
305mm x 305mm (12" x 12")

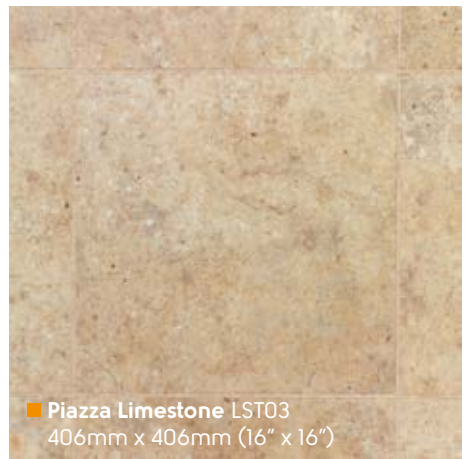

■ Piazza Limestone LST03
406mm x 406mm (16" x 16")



CC04 ▽



■ Cappuccino CK22
406mm x 406mm (16" x 16")



■ Spirito Limestone LST04
406mm x 406mm (16" x 16")

Da Vinci Light Stone

Please see page 8 for size comparison guide

Find your nearest retailer at www.karndean.com/FAR or call 01386 820100



Our wide range of decorative borders can help you personalise your space

CK24 ▽

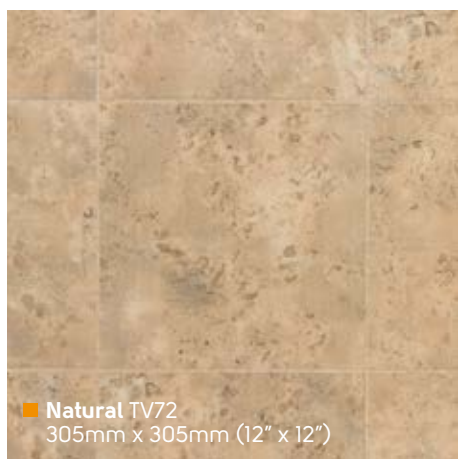

■ **Natural TV72**
305mm x 305mm (12" x 12")



■ **Mocha CK24**
406mm x 406mm (16" x 16")



■ **Espresso CK21**
406mm x 406mm (16" x 16")



■ **Santi Limestone LST05**
406mm x 406mm (16" x 16")

Da Vinci Mid Stone

Please see page 8 for size comparison guide

Find your nearest retailer at www.karndean.com/FAR or call 01386 820100



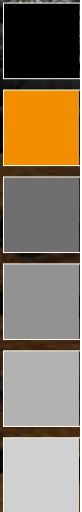

Achieve an aged,
farmhouse
feel with rugged
textures







CC08 ▽



CC06 ▽

Pair dark stone tiles with bright, bold pops of colour for a modern look



■ Sepia CC03



■ Java CK26



■ Hydria CC07

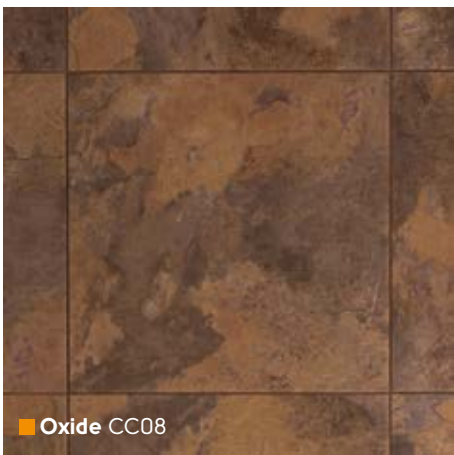

■ Oxide CC08



■ Graphite CC06



■ Noir CK25

Da Vinci Dark Stone

406mm x 406mm (16" x 16") Please see page 8 for size comparison guide

Find your nearest retailer at www.karndean.com/FAR or call 01386 820100





Mosaics

MX92 Δ



Pebbles

MS2 Δ



Metallics

MLC08 Δ

Michelangelo

Michelangelo Stone

15 year guarantee: residential use

Our Michelangelo collection contains some of our most unique designs. The soft contours of our Pebble and the contemporary Metallic effects use some of our most advanced techniques of registered embossing.

You can create a truly unique look by using Mosaic, Pebble and Metallic effect tiles, available in a variety of colours.

Mosaics page 89

Pebbles page 90

Metallics page 93





MX92 ▽

Our pebble and mosaic floors are ideal for bathrooms



■ Ancient Onyx MX95

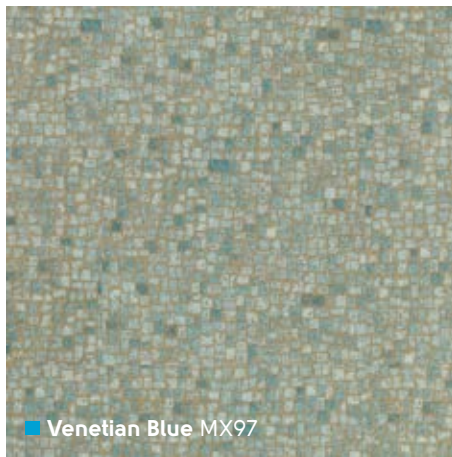

■ Venetian Blue MX97



■ Neopolitan Brick MX93



MX92 ▽



■ Adriatic Blue MX98



■ Umbrian Nero MX92

Michelangelo Mosaic

305mm x 305mm (12" x 12") Please see page 8 for size comparison guide

Find your nearest retailer at www.karndean.com/FAR or call 01386 820100



MS5 ▽

Andalucian Opal comes in this pretty pattern of pebble tiles with wide design strips



MS3 ▽

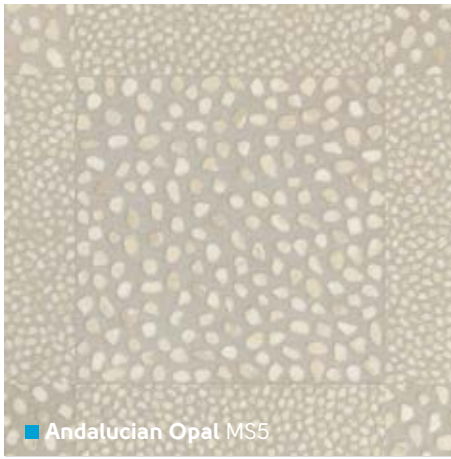

■ Andalucian Opal MS5

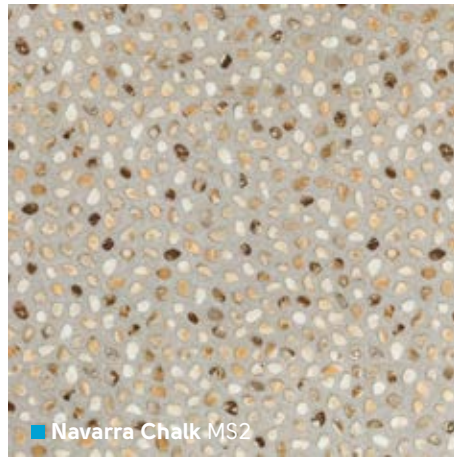

■ Navarra Chalk MS2

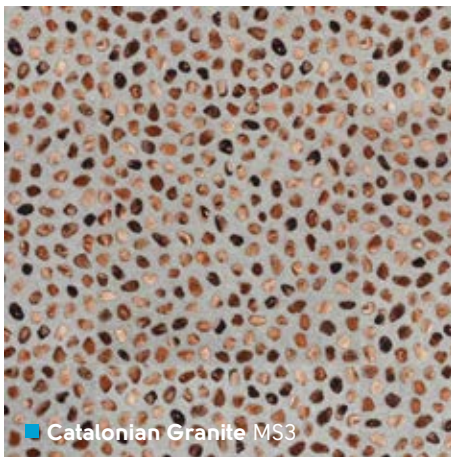

■ Catalonian Granite MS3

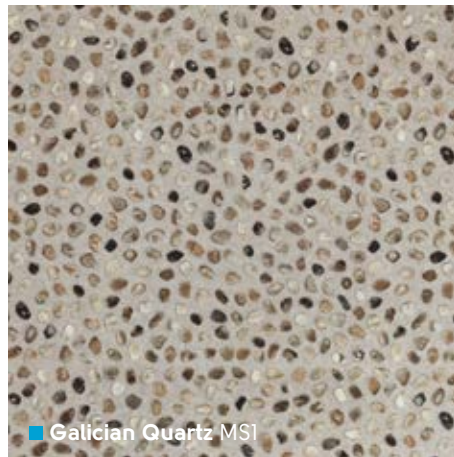

■ Galician Quartz MS1

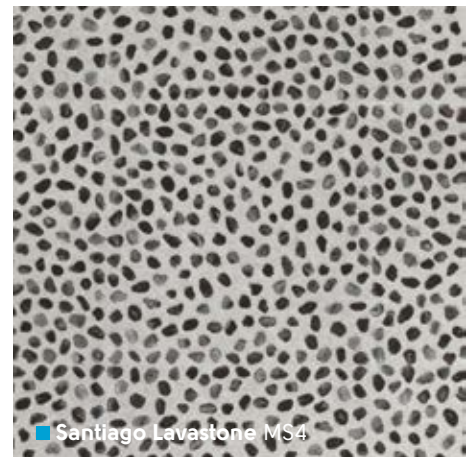

■ Santiago Lavastone MS4

Michelangelo Pebble

305mm x 305mm (12" x 12") Please see page 8 for size comparison guide

Find your nearest retailer at www.karndean.com/FAR or call 01386 820100







MLC08 ▽

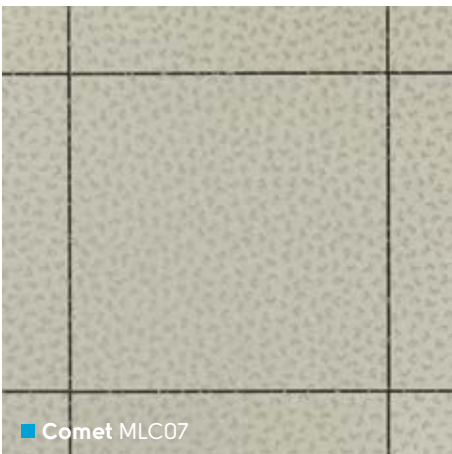

■ Comet MLC07

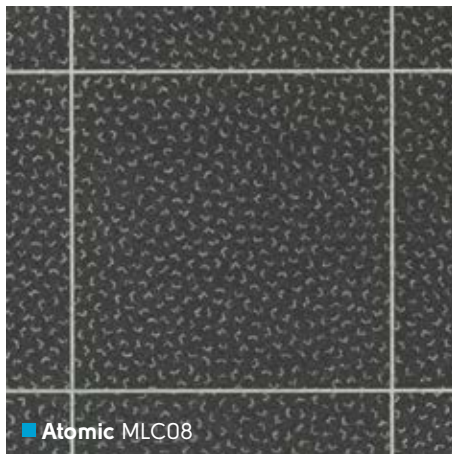

■ Atomic MLC08

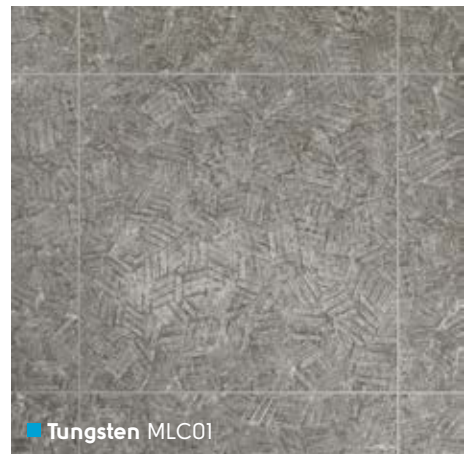

■ Tungsten MLC01

Michelangelo Metallica

406mm x 406mm (16" x 16") Please see page 8 for size comparison guide

Find your nearest retailer at www.karndean.com/FAR or call 01386 820100





Larger tiles

SP212 Δ



Smooth surface finish

SP213 & SP115 Δ



Contemporary designs

SP215 Δ



Opus Stone

15 year guarantee: residential use

Our Opus collection includes a range of contemporary stone effects available in some of our largest tile sizes. The smoother surface and range of colours create a really clean, modern look to suit most spaces. Add complementary design strips between tiles for a realistic grout effect.



Light stone page 96

Mid stone page 99

Dark stone page 100



Lighten up your space
with stylish pale tones

SP111 ▽



■ **Luna SP111**
457mm x 457mm (18" x 18")



■ **Solis SP112**
457mm x 457mm (18" x 18")

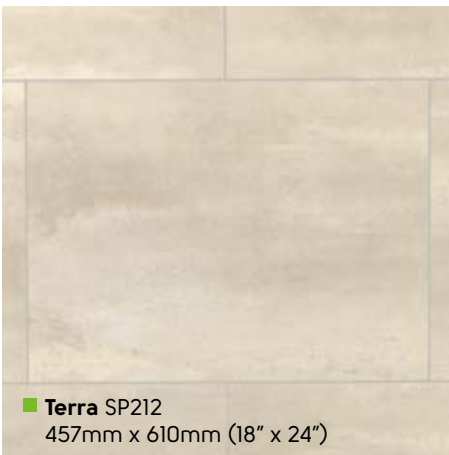

■ **Terra SP212**
457mm x 610mm (18" x 24")



■ **Sandstone TT34**
305mm x 457mm (12" x 18")

Opus Light Stone

Please see page 8 for size comparison guide

Find your nearest retailer at www.karndean.com/FAR or call 01386 820100

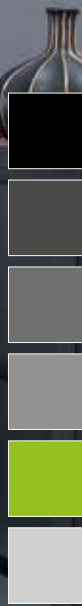
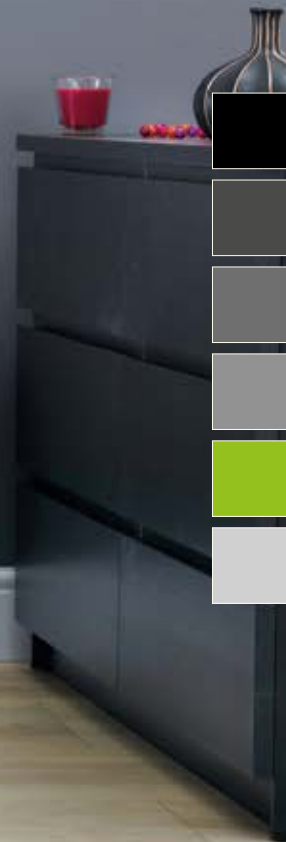

■ Terra SP212 with AF04 3mm design strip





SP211 ▽



SP213 ▽



SP211 ▽

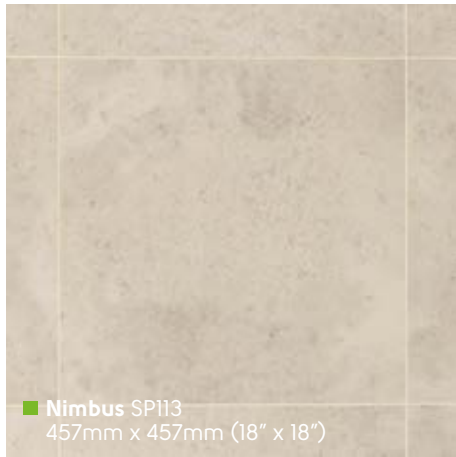

■ **Nimbus** SP113
457mm x 457mm (18" x 18")



■ **Mico** SP211
457mm x 610mm (18" x 24")



■ **Urbus** SP213
457mm x 610mm (18" x 24")

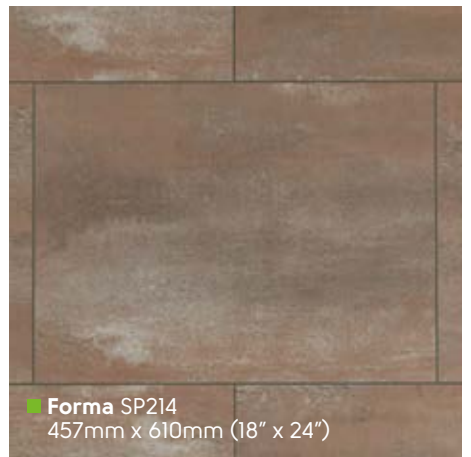

■ **Forma** SP214
457mm x 610mm (18" x 24")

Opus Mid Stone

Please see page 8 for size comparison guide

Find your nearest retailer at www.karndean.com/FAR or call 01386 820100

RENZI ▾



■ **Ferra** SP215
457mm x 610mm (18" x 24")

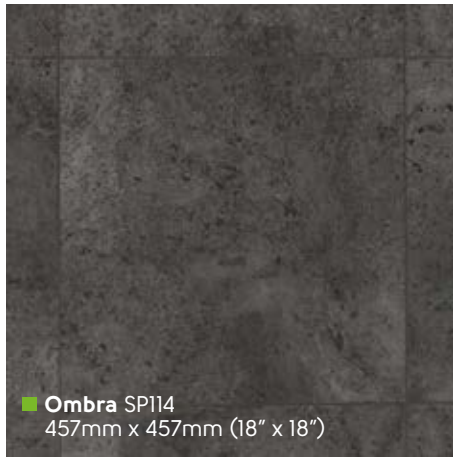

■ **Ombra** SP114
457mm x 457mm (18" x 18")

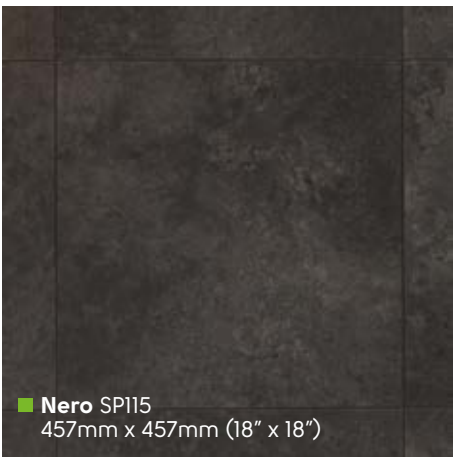

■ **Nero** SP115
457mm x 457mm (18" x 18")



■ **Atlantic Slate** REN21
915mm x 915mm (36" x 36")*



Opus Dark Stone

*A pre-assembled panel of 9 assorted tiles with design strip and offsetting tiles to create a random look
Please see page 8 for size comparison guide

Find your nearest retailer at www.karndean.com/FAR or call 01386 820100



■ Ferra SP216 with DS17 3mm design strip





Widest selection

T99 Δ



Lightly textured surface

ST14 Δ



Easy to personalise

T101 Δ

Knight Tile

Knight Tile Stone

12 year guarantee: residential use

In our Knight Tile collection, you'll find a great selection of effects and styles to suit your needs, at our most affordable prices. Each colour and design reflects a wide range of natural materials from classic pale to contemporary dark stones for any space in your home.

Light stone page 104

Mid stone page 107

Dark stone page 109

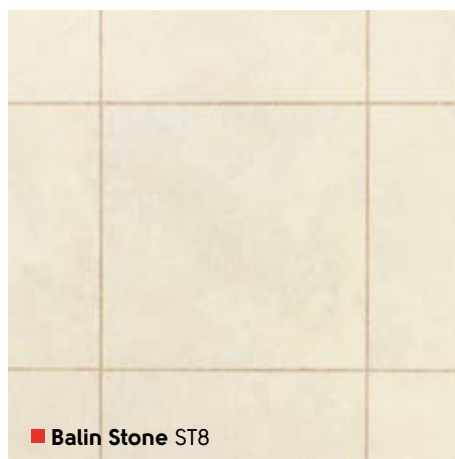

Knight Tile Light Stone

305mm x 305mm (12" x 12") Please see page 8 for size comparison guide

Find your nearest retailer at www.karndean.com/FAR or call 01386 820100



■ **Balin Stone ST8** with DS14 3mm design strip





Try adding a border to define your room

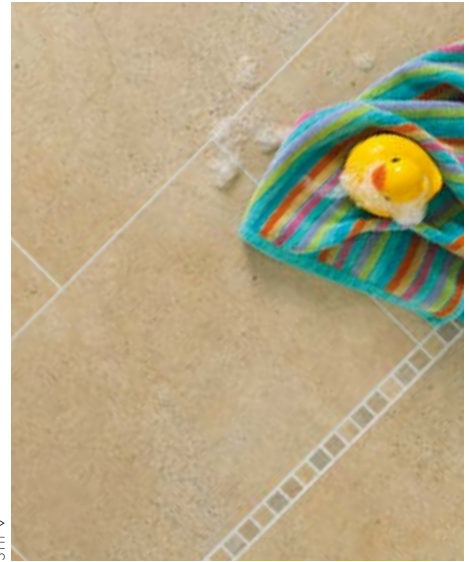

ST13 ▽

ST13 ▽

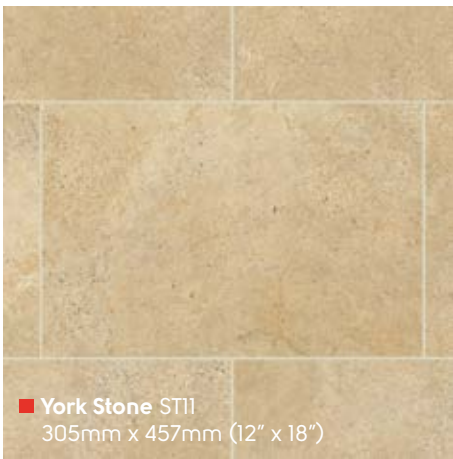

■ **York Stone ST11**
305mm x 457mm (12" x 18")



■ **Bath Stone ST12**
305mm x 457mm (12" x 18")

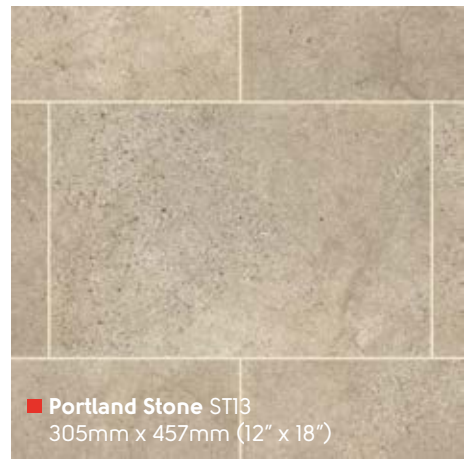

■ **Portland Stone ST13**
305mm x 457mm (12" x 18")



■ **Rona T99**
305mm x 305mm (12" x 12")

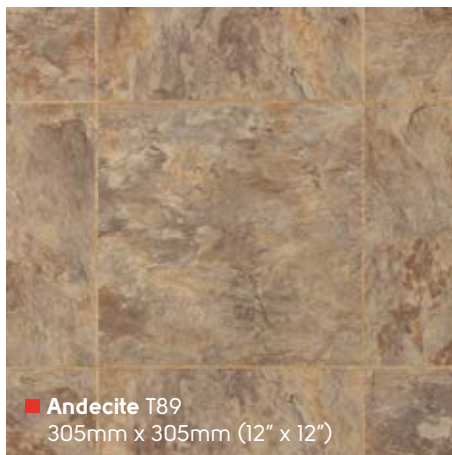

■ **Andecite T89**
305mm x 305mm (12" x 12")

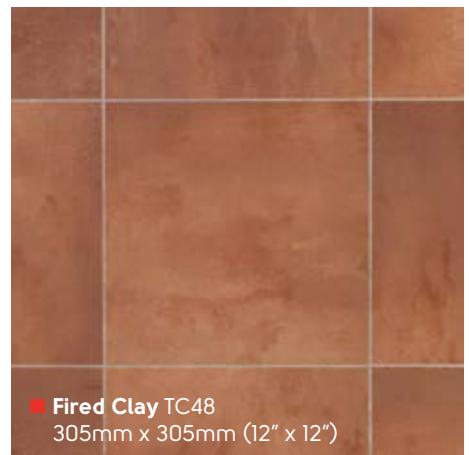

■ **Fired Clay TC48**
305mm x 305mm (12" x 12")

Knight Tile Mid Stone

Please see page 8 for size comparison guide

Find your nearest retailer at www.karndean.com/FAR or call 01386 820100





T101

T102

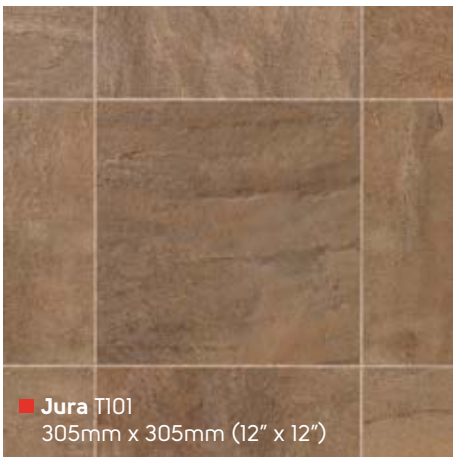

■ **Jura T101**
305mm x 305mm (12" x 12")



■ **Ramsey T102**
305mm x 305mm (12" x 12")



■ **Cumbrian Stone ST14**
305mm x 457mm (12" x 18")



■ **Orkney T100**
305mm x 305mm (12" x 12")

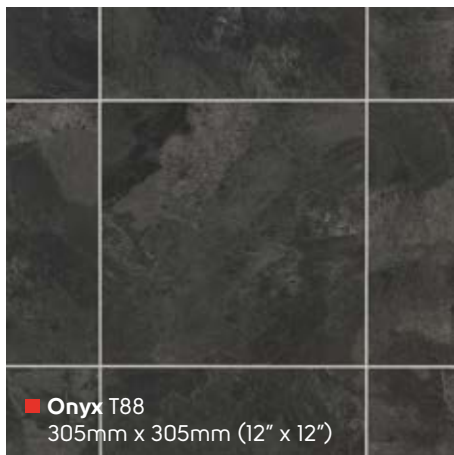

■ **Onyx T88**
305mm x 305mm (12" x 12")



■ **Midnight Black T74**
305mm x 305mm (12" x 12")

Knight Tile Dark Stone

Please see page 8 for size comparison guide

Find your nearest retailer at www.karndean.com/FAR or call 01386 820100

Your guide to Design Strips...

To complete your look, add a design strip. Choose from a wide range of tones and textures available in **3, 5, 10, 30 and 76mm** (unless otherwise specified). Place these between tiles to create a natural grouting effect or to enhance the design of your floor. We have a wide range of strips, but they only work with certain products. Your retailer will be able to help you select the right strip for your chosen floor.

Compatible with...



Design strips available for use with:
Art Select, Da Vinci, and Van Gogh floors.



Cotswold SS6



Scandinavian Beech RP04



American Oak RP11



Indian Teak RP12



French Chestnut RP13



Australian Walnut RP41



Burnt Ginger VG5



Lime VG6



Midnight Oak HC06



Spring Oak RL01

Only available in 30mm bevelled strip



Dawn Oak HC01

Only available in 30mm bevelled strip

Compatible with...



Design strips available for use with:
Da Vinci, Opus, and Michelangelo floors.

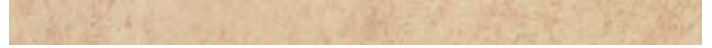

Cotswold SS6



Utah REN34



Gold J86



Beechwood P504



Burnt Ash MP3



Golden Teak P702



Mahogany P802



Honey Beech P707



Midnight Oak HC06



Mercury J89



Atomic MLC08



Comet MLC07



Galician Quartz MS1

Only available in 10, 30, 76mm widths



Navarra Chalk MS2

Only available in 10, 30, 76mm widths



Neopolitan Brick MX93

We recommend only using this strip in 10, 30, and 76mm widths



■ **Blond Oak AP01** with P802 3mm and RL01 30mm design strips



■ **Santi Limestone LST05** with REN34 3mm design strip



■ **Walnut VGW87T** with DS07 5mm design strip



■ **Ignea WP313** with DS07 3mm design strip



Compatible with...



These design strips available for use with all our floors. Available in 3, 5 and 10mm widths.



Vanilla DS01



Blond DS02



Honey DS03



Coffee DS04



Russet DS05



Chocolate DS06



Ebony DS07



Cocoa Cross Grain DS08



Carbon Cross Grain DS09

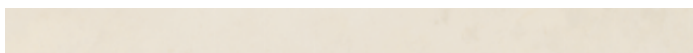

Chalk DS10



Concrete DS12



Sand DS13



Stone DS14



Clay DS15



Charcoal DS16



Silver DS17



Frost DS18



Kohl DS19

Compatible with...



Metallic strips are available in a range of five colours. For use with Da Vinci, Opus and Michelangelo floors.



Silver



Gold



Blue



Copper



Purple

Compatible with...



Grout strips are available in a range of six colours at 3mm and 5mm wide. For use with Da Vinci, Opus and Michelangelo floors.



Beige AF06



Ivory AF05



Taupe AF04



Brown AF02



Chestnut AF07



Black AF01

If you're looking for something completely bespoke, consider using the design service offered by your local retailer who can advise you on custom-made design strips.

Decorative Wood Borders

Why not finish your floor with one of our decorative wood borders? To help you choose, we've made some suggestions below.

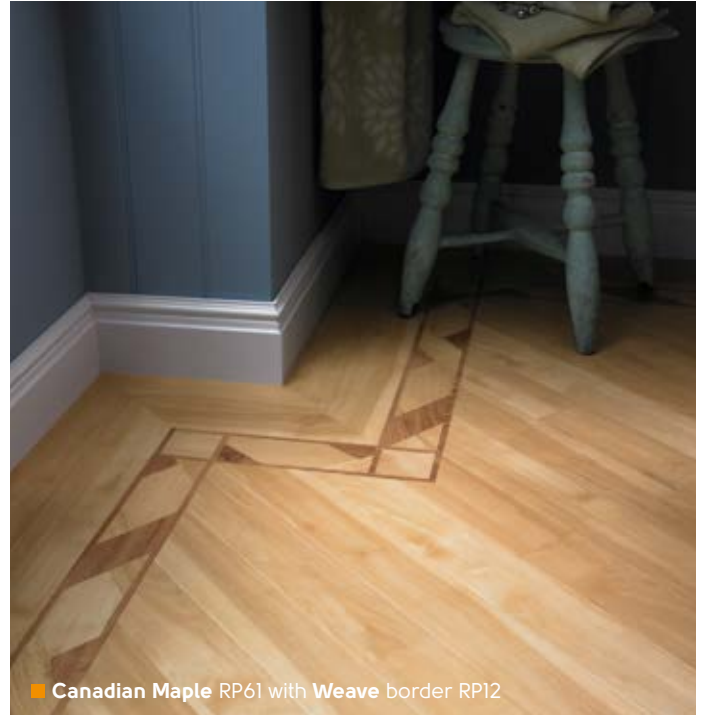
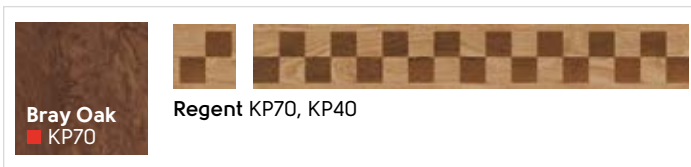
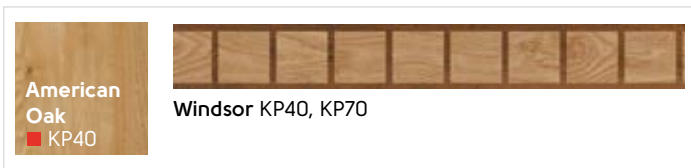
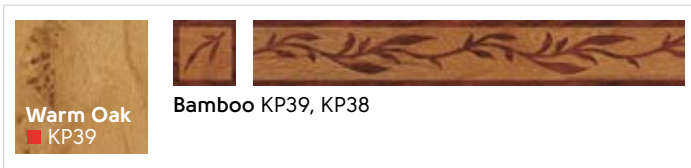
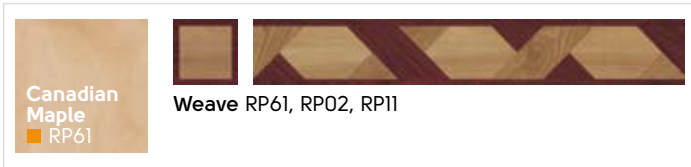
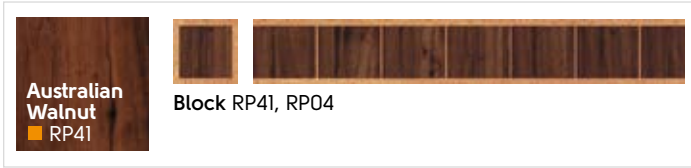

Looking for a custom border to suit your floor?

Your local retailer will offer you a design service to help you choose a style.

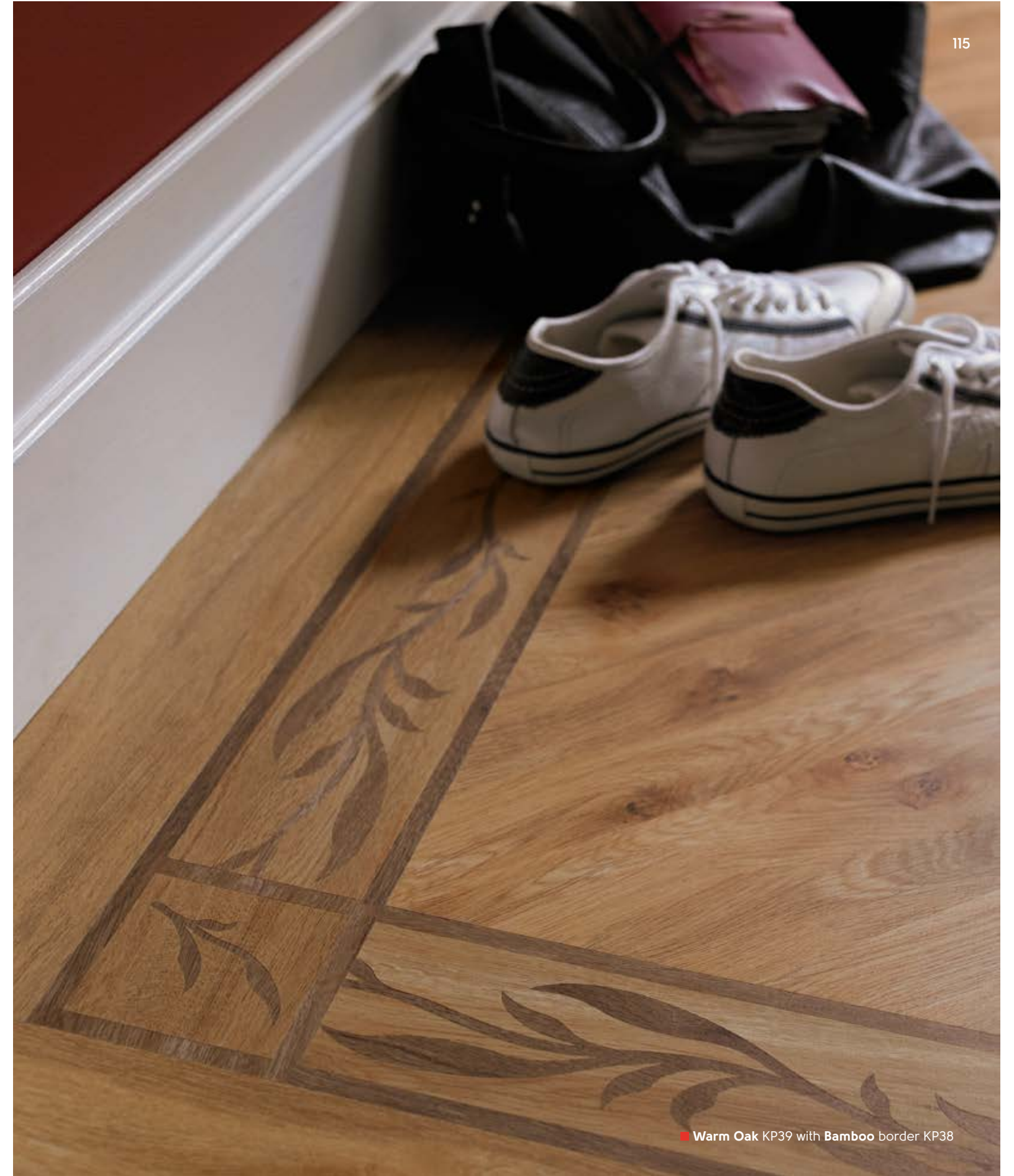

■ Warm Oak KP39 with Bamboo border KP38



Decorative Stone Borders

Add interest to your floor with one of our decorative stone borders?
To help you choose, we've made some suggestions below.

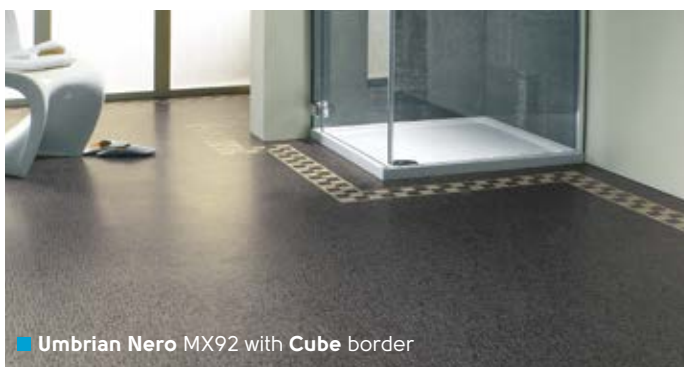
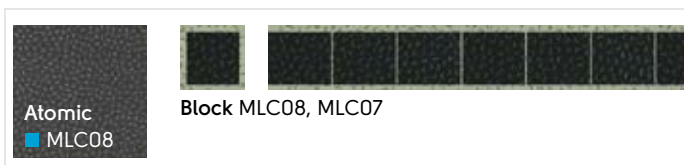
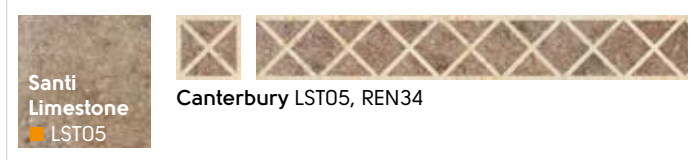
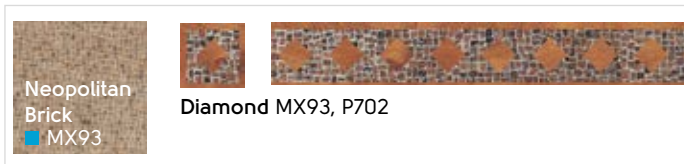
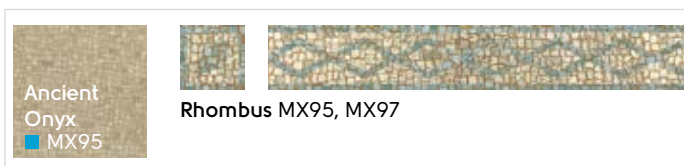
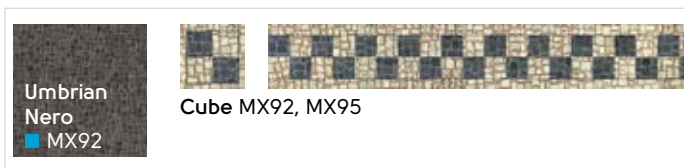
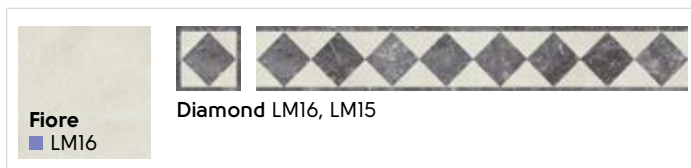







*Features are 3ft wide
as standard but can be
scaled up or down*

Bespoke Features

1 Pick your favourite from our standard feature designs



Cartwheel with border



Cartwheel



Celtic



Galaxy



Dolphin



Sun



Star

2 Choose your own colours

We recommend you make the background colour of your chosen feature the same as your floor, then choose remaining colours to coordinate with the finishes in your room.

3 Decide on a size

You can select the size of your feature to fit perfectly into any shape of room. Our features come in a standard 3ft size, but can be scaled up or down to suit. Talk to your local retailer who can advise you on getting the right size for your space.

Looking for a bespoke design?

If you're looking for something a little bit different, you can design your own unique feature. Take a sketch of your idea to your nearest retailer for help creating a truly bespoke floor for your home.

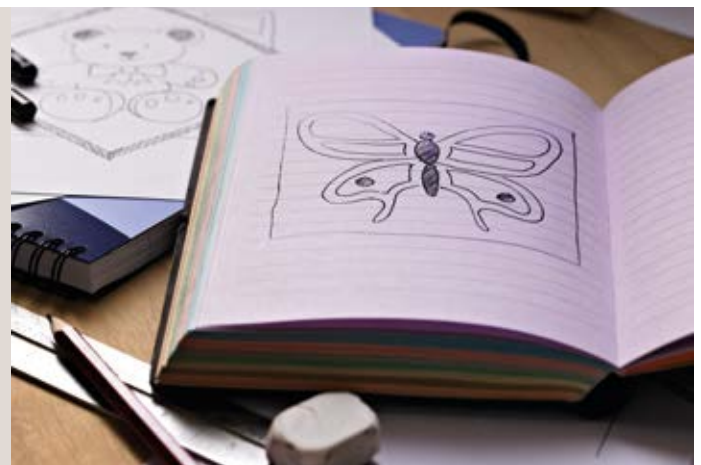





Karndean
Designflooring

Karndean
LooseLay

What makes Karndean LooseLay special?

Karndean
LooseLay

Karndean LooseLay is a new format of luxury vinyl flooring featuring a friction grip backing that holds the product in place.

Boasting the realistic designs and grain details customers expect from Karndean, LooseLay is available in large scale wood look planks and stone look tiles and can help you create a look that works in almost any space. What's more, it's easy to install and can be laid over most existing hard floors. Oh, and it's 100% recyclable!

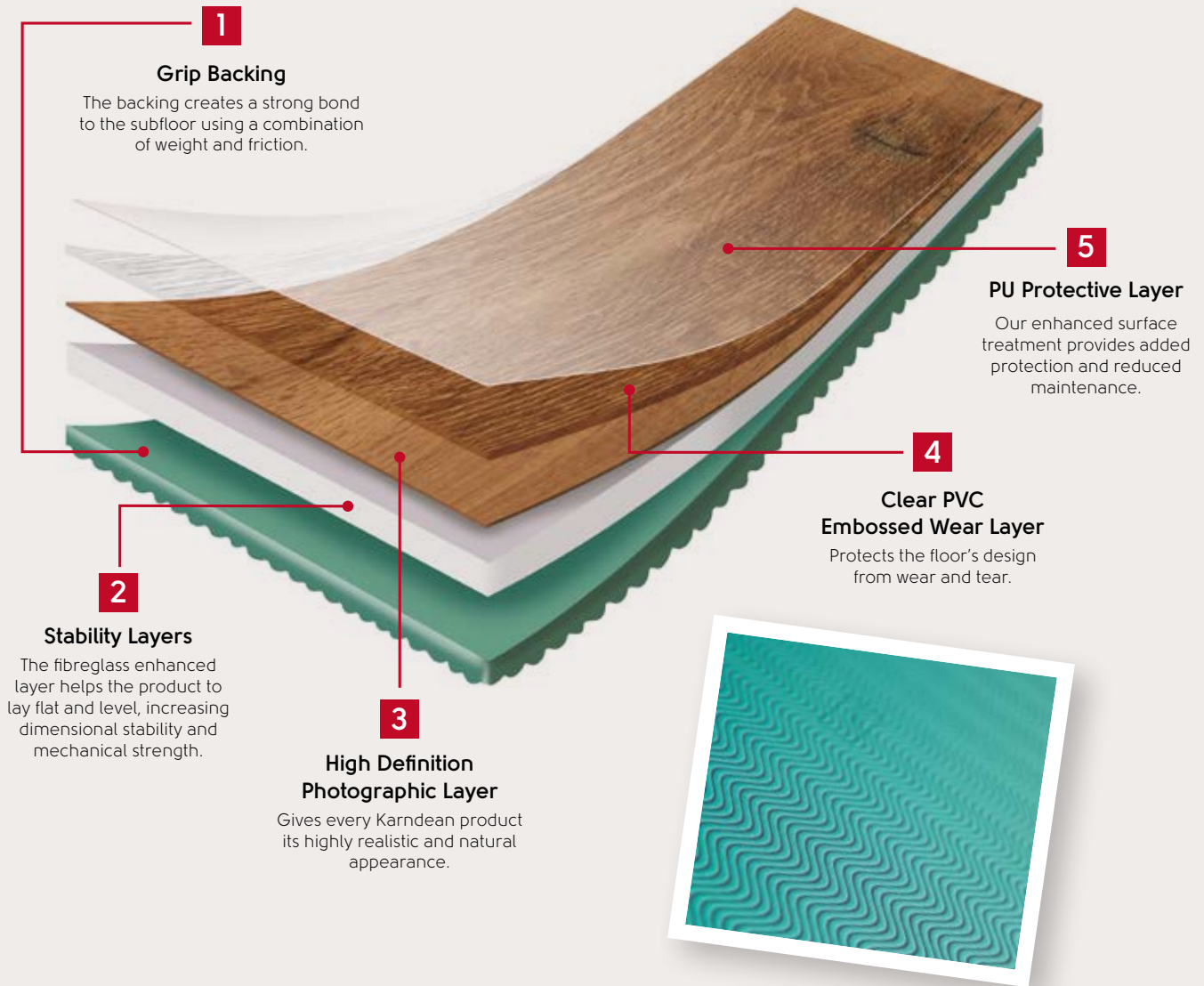

Why Karndean LooseLay?



Quick and easy to install

All you need is a sound, smooth, dry and dust free subfloor. **Karndean LooseLay** can be fitted over most existing hard floors*.

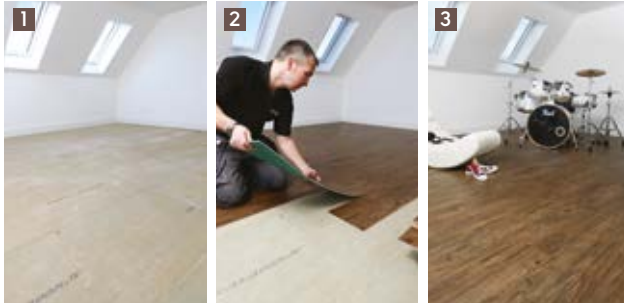

Compatible with underfloor heating

Up to 27°C



Individually replaceable

Should you need to replace a piece, simply lift the damaged plank or tile and replace with a new one.

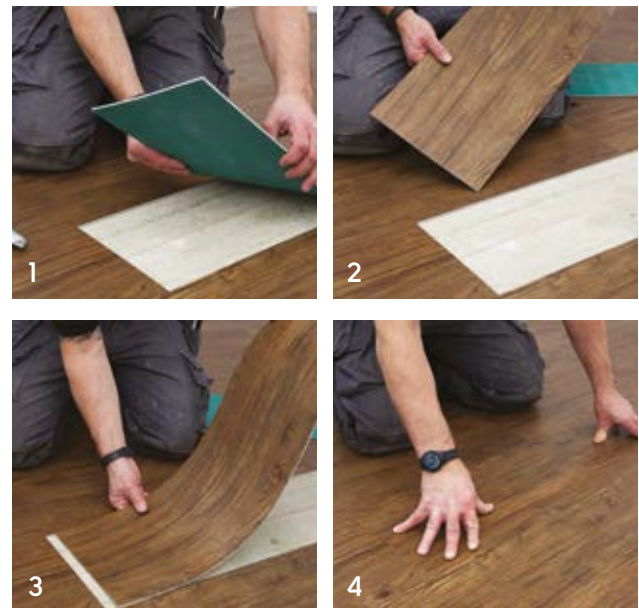

Acoustic qualities

Karndean LooseLay is perfect for projects where you want to reduce noise levels in the room below, such as playrooms, bedrooms and garage/ loft conversions without the need for underlay.



Comfortable underfoot

Our products are softer and warmer underfoot than natural wood and stone flooring. Additional cushioning in the backing helps make the product more comfortable underfoot.



Realistic designs

Available in contemporary larger scale planks and tiles, **Karndean LooseLay** is available in a variety of colour tones and styles.



Durable

Karndean LooseLay is extremely hardwearing. Unlike real wood and stone, it won't splinter, warp or crack.



100% recyclable



Low maintenance

We use PU technology to ensure that there is no need to apply an additional surface treatment following installation.





▲ LLP1011

Easy and quick to change
the look of your space



■ Country Oak LLP92

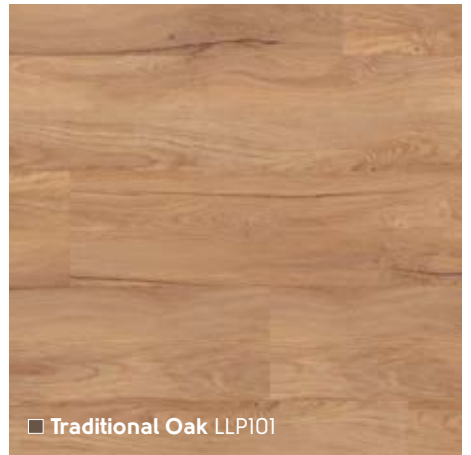

□ Traditional Oak LLP101

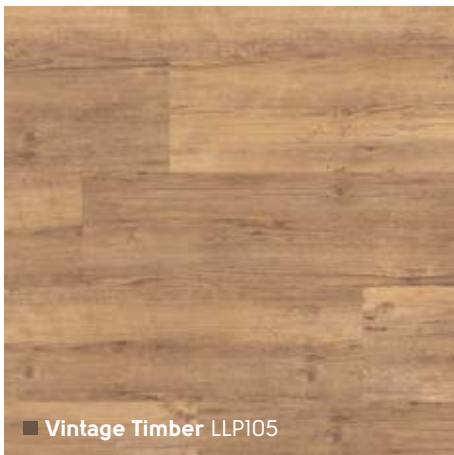

■ Vintage Timber LLP105

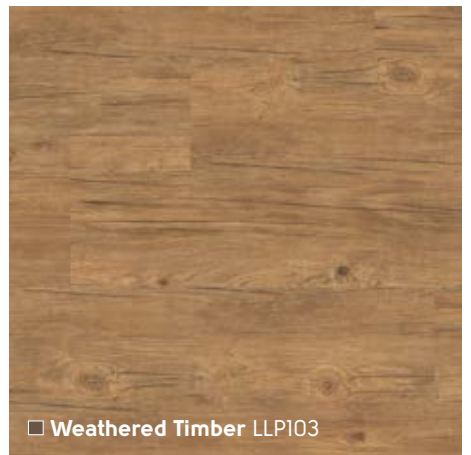

□ Weathered Timber LLP103

Karndean LooseLay Series One Wood

1050mm x 250mm (41.3" x 9.85")

Find your nearest retailer at www.karndean.com/FAR or call 01386 820100

Enhanced
acoustic
benefits

LLP104 ▽



LLP104 ▽

□ Antique Timber LLP106



□ Heritage Oak LLP102

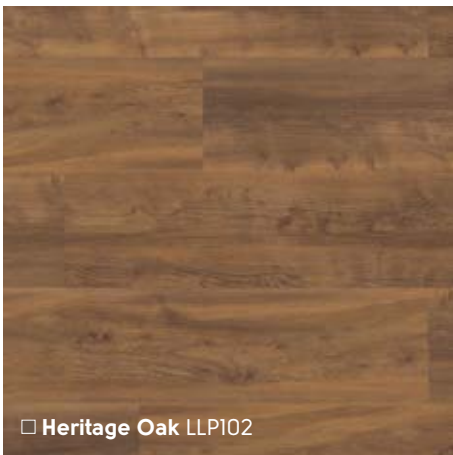

□ Rustic Timber LLP104

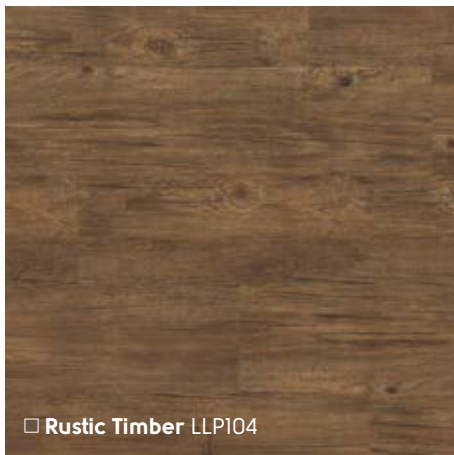

Karndean LooseLay Series One Wood

1050mm x 250mm (41.3" x 9.85")

Find your nearest retailer at www.karndean.com/FAR or call 01386 820100







LLP93

LLP93

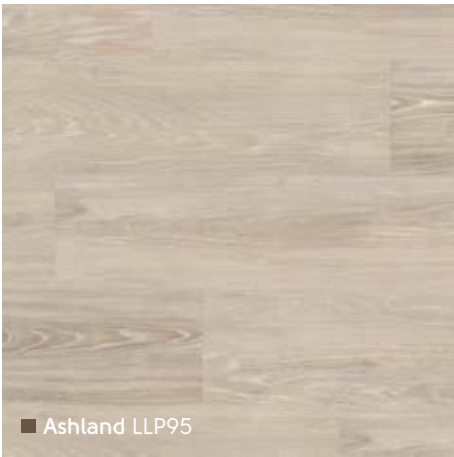

■ Ashland LLP95

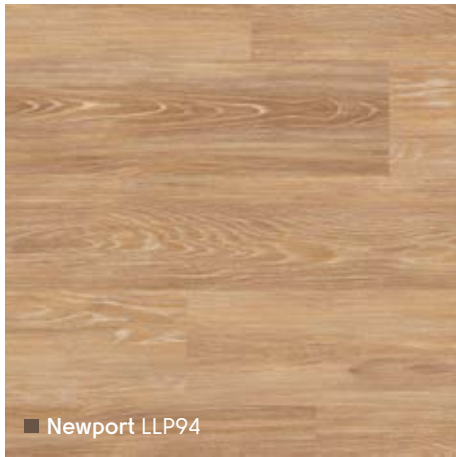

■ Newport LLP94

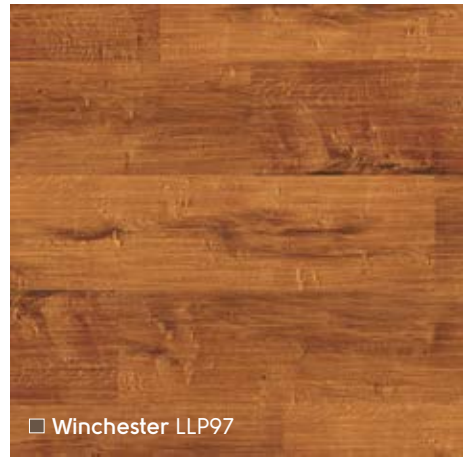

□ Winchester LLP97



■ Hudson LLP99

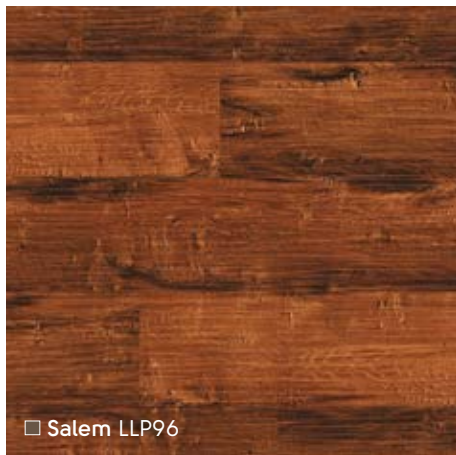

□ Salem LLP96

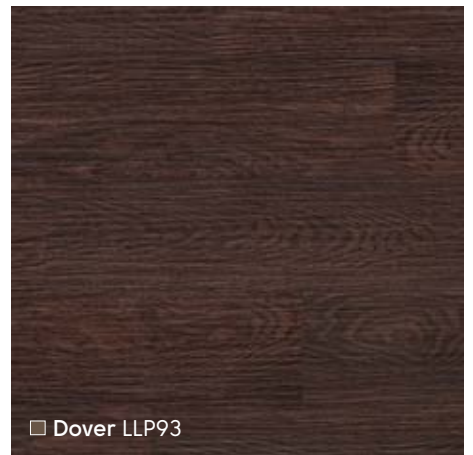

□ Dover LLP93

Karndean LooseLay Series Two Wood

All Series Two woods feature a hand scraped finish. 1050mm x 250mm (41.3" x 9.85")

Find your nearest retailer at www.karndean.com/FAR or call 01386 820100



LLP108



LLP112

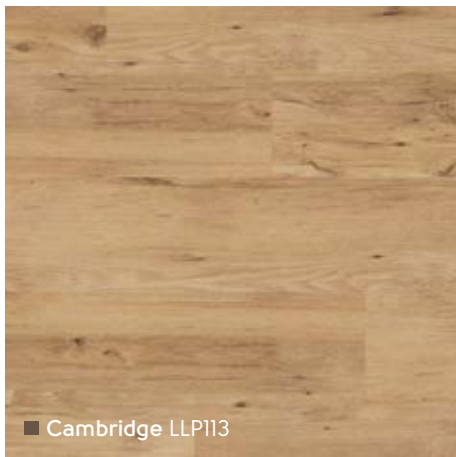

■ Cambridge LLP113

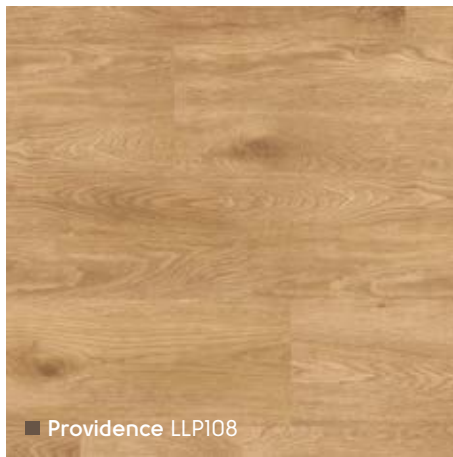

■ Providence LLP108

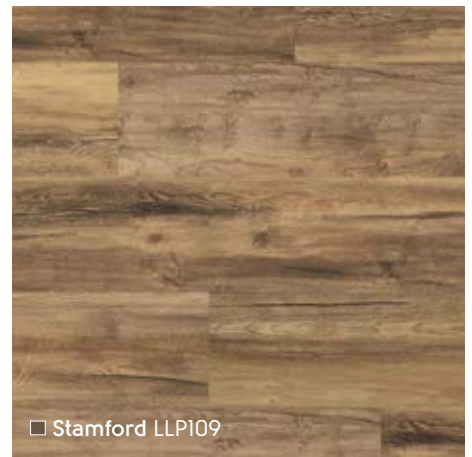

□ Stamford LLP109

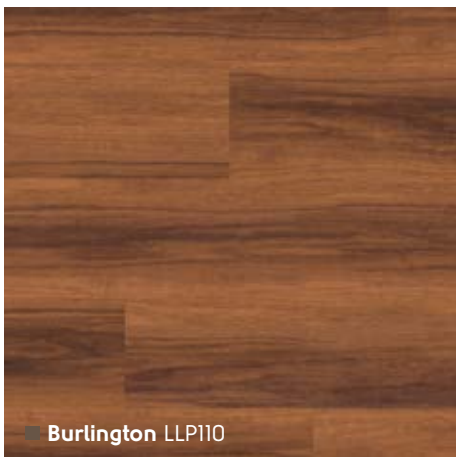

■ Burlington LLP110

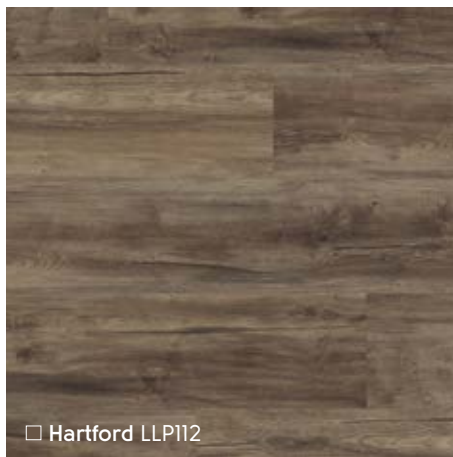

□ Hartford LLP112

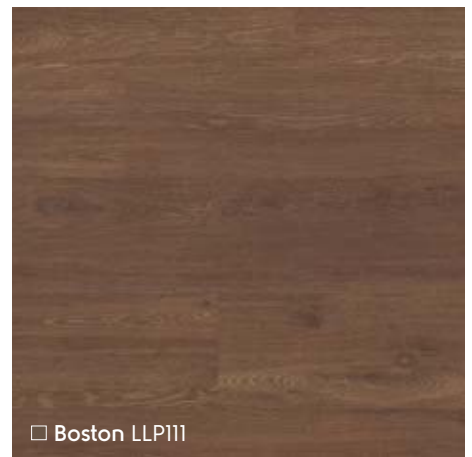

□ Boston LLP111

Karndean LooseLay Series Three Wood

1050mm x 250mm (41.3" x 9.85")

Find your nearest retailer at www.karndean.com/FAR or call 01386 820100







LLT203 ▽



LLT202 ▽

Perfect for any room in your home



LLT200 ▽



■ Indiana LIT202



■ Colorado LIT201



□ Arizona LIT200



□ Madison LIT203

Karndean LooseLay Series One Stone

500mm x 610mm (19.7" x 24")

Find your nearest retailer at www.karndean.com/FAR or call 01386 820100



Enhanced
acoustic
benefits

LLT206 ▽



□ Georgia LLT206



□ Texas LLT207



Karndean LooseLay Series Two Stone

500mm x 610mm (19.7" x 24")

Find your nearest retailer at www.karndean.com/FAR or call 01386 820100

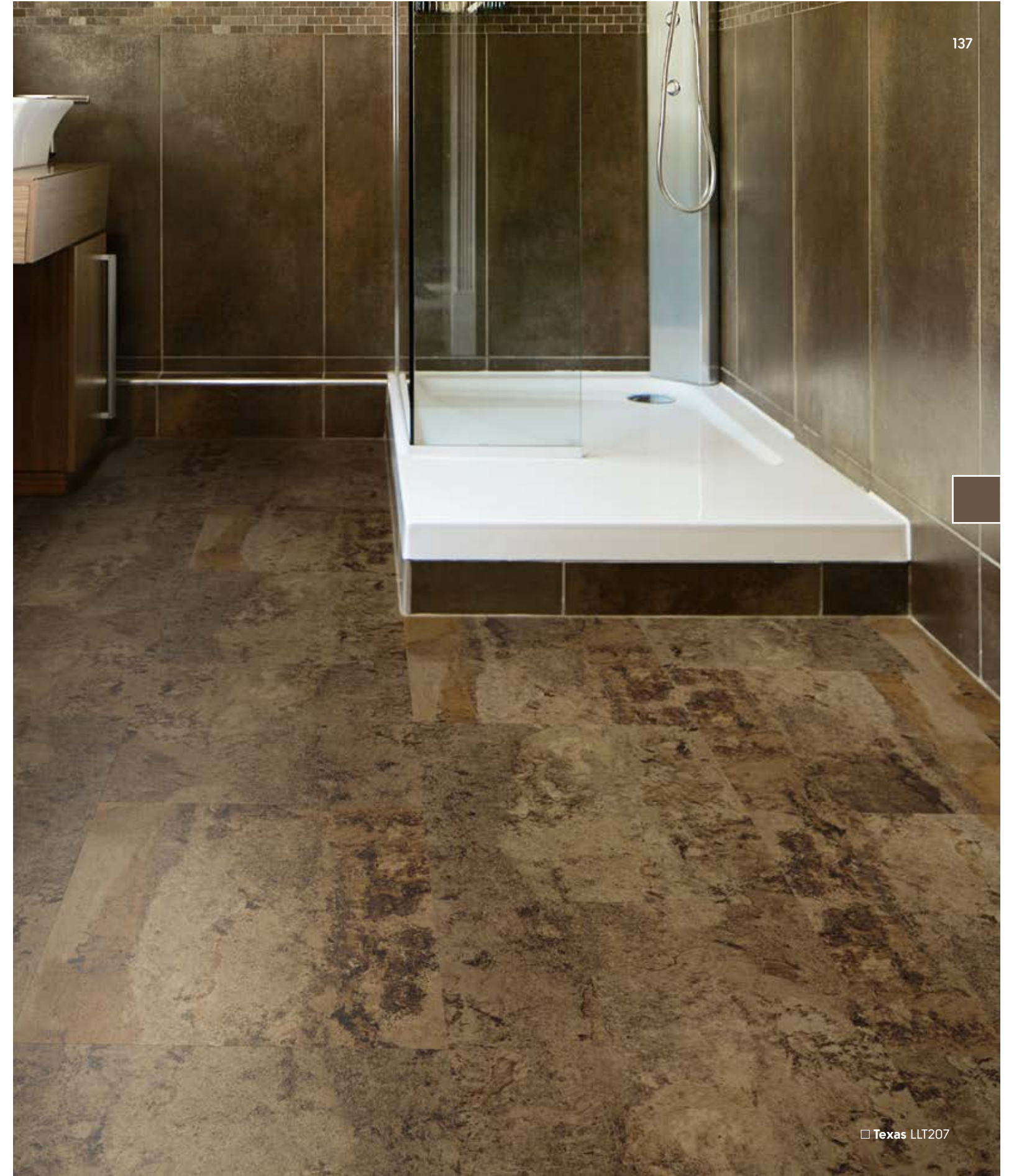





Enhanced
acoustic
benefits

LLT204



□ Pennsylvania LLT204



□ Nevada LLT205

Karndean LooseLay Series Two Textile

500mm x 610mm (19.7" x 24")

Find your nearest retailer at www.karndean.com/FAR or call 01386 820100

Art Select at a glance

Parquet 228mm x 76mm (9" x 3")



Blond Oak AP01



Morning Oak AP06



Auburn Oak AP02



Spanish Cherry AP05



Sundown Oak AP04

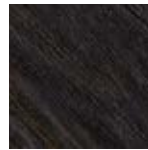

Black Oak AP03

406mm x 406mm (16" x 16")



Russet Oak AP31

Oak Royale 1219mm x 178mm (48" x 7")



Spring Oak RL01



Summer Oak RL02



Autumn Oak RL03



Winter Oak RL04



Spanish Cherry RL05



Santina Cherry RL07

Oak Premier 915mm x 152mm (36" x 6")



Dawn Oak HC01



Morning Oak HC02



Dusk Oak HC03



Sundown Oak HC04



Evening Oak HC05



Midnight Oak HC06

Handcrafted 915mm x 152mm (36" x 6")



Hickory Paprika EW01



Hickory Nutmeg EW03



Hickory Peppercorn EW02

Da Vinci at a glance

915mm x 76mm (36" x 3")

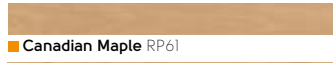

Canadian Maple RP61



American Oak RP11



Fresco Light Oak RP90

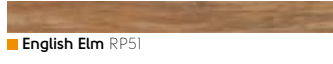

English Elm RP51



Indian Teak RP12



Swedish Birch RP75

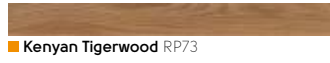

Kenyan Tigerwood RP73

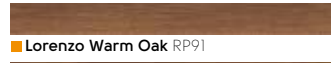

Lorenzo Warm Oak RP91

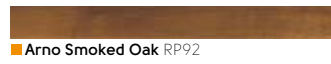

Arno Smoked Oak RP92

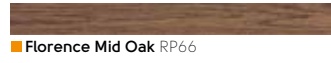

Florence Mid Oak RP66

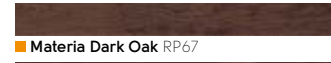

Materia Dark Oak RP67

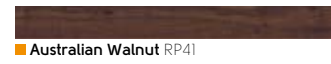

Australian Walnut RP41

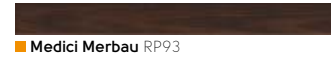

Medici Merbau RP93

Van Gogh at a glance

1219mm x 178mm (48" x 7")



White Washed Oak VGW80T



Macrocapra VGW50T



Birch VGW84T



French Oak VGW85T



Distressed Oak VGW82T



Country Oak VGW81T



Frosted Birch VGW83T



Auckland Oak VGW52T



Antique Karri VGW39T



Reclaimed Maple VGW71T



Wellington Oak VGW53T



Vintage Pine VGW76T

Van Gogh at a glance (continued...)

1219mm x 178mm (48" x 7")



■ Lancewood VGW44T



■ Smoked Oak VGW70T



■ Brushed Oak VGW88T



■ Classic Oak VGW86T



■ Christchurch Oak VGW54T



■ Ebony VGW89T



■ Burnt Ginger VG5-7



■ Aged Kauri VGW51T



■ Bracken VGI-7



■ Walnut VGW87T

Opus at a glance

915mm x 152mm (36" x 6")



■ Grano WP311



■ Ignea WP313



■ Palleo WP312



■ Rubra WP316



■ Cera WP314



■ Atra WP317



■ Aurum WP315



■ Carbo WP318

915mm x 102mm (36" x 4")



■ Weathered Elm REN113

1219mm x 228mm (48" x 9")



■ Niveus WP411



■ Primo WP412



■ Magna WP413



■ Argen WP414

Knight Tile at a glance

915mm x 102mm (36" x 4")

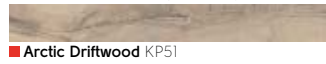

■ Arctic Driftwood KP51



■ Pitch Pine KP45



■ Sycamore KP32



■ Sienna KP107



■ Shannon Oak KP68

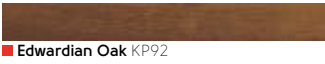

■ Edwardian Oak KP92



■ Pear KP55



■ Tudor Oak KP38

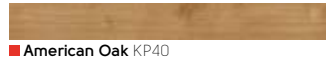

■ American Oak KP40



■ Native Koa KP93

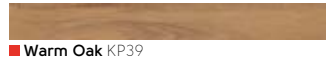

■ Warm Oak KP39

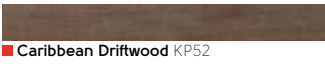

■ Caribbean Driftwood KP52

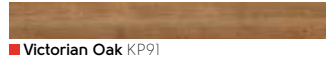

■ Victorian Oak KP91



■ Bray Oak KP70



■ Aran Oak KP67

915mm x 152mm (36" x 6")



■ White Painted Oak KPI05



■ Mid Limed Oak KP96



■ Pale Limed Oak KP94



■ Mid Worn Oak KPI03

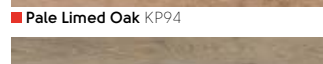

■ Lime Washed Oak KP99

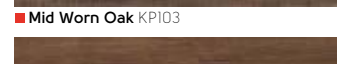

■ Mid Brushed Oak KPI02



■ Classic Limed Oak KP97

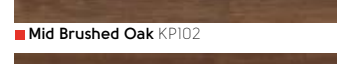

■ Aged Oak KP98

Art Select at a glance

Limestone 915mm x 915mm (36" x 36") Random Panel*



■ Jersey LM01



■ Guernsey LM02



■ Alderney LM03



■ Herm LM20

Welsh Slates 915mm x 915mm (36" x 36") Random Panel*



■ Oakeley LM11

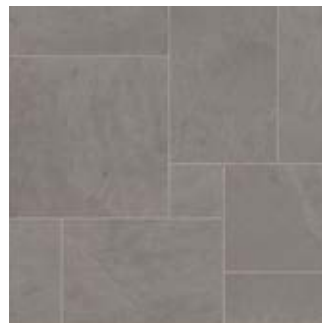

■ Corris LM12

Travertine 457mm x 610mm (18" x 24")



■ Washburn LM07



■ Caldera LM08



■ Gallatin LM09

Travertine 152mm (6") x FreeLengths**



■ Washburn LM17



■ Caldera LM18



■ Gallatin LM19

**These stones are 6" wide in varying lengths.

Ashford Marble 915mm x 915mm (36" x 36") Random Panel*



■ Ashford LM10

Italian Marbles 406mm x 406mm (16" x 16")

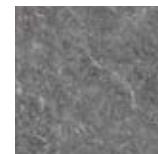

■ Otono LM15



■ Fiore LM16



supplied with LM16 Key Squares
■ Otono LM15-CLIP



supplied with LM15 Key Squares
■ Fiore LM16-CLIP

Parliament Slates 457mm x 610mm (18" x 24")



■ Melbourne LM05



■ Canberra LM06

*Made up in a pre-assembled panel of 9 assorted tiles with design strip and offsetting tiles to create a random look.

Da Vinci at a glance

406mm x 406mm (16" x 16")



■ Limestone LST01



■ Alabaster CC04

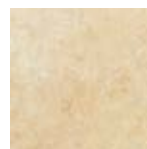

■ Sienna Limestone LST02



■ Latte CK23



■ Piazza Limestone LST03



■ Cappuccino CK22



■ Spirito Limestone LST04



■ Mocha CK24

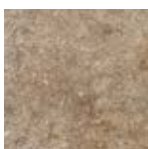

■ Santi Limestone LST05



■ Espresso CK21



■ Sepia CC03



■ Java CK26



■ Oxide CC08

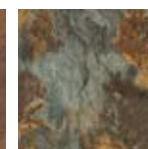

■ Hydria CC07

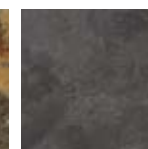

■ Graphite CC06



■ Noir CK25



■ Bianco M45-12



■ Cotswold SS6



■ Natural TV72

305mm x 305mm (12" x 12")

Michelangelo at a glance

305mm x 305mm (12" x 12")



406mm x 406mm (16" x 16")



***Supplied with 76mm (3") mini pebble design strips and key squares

Opus at a glance

915mm x 915mm (36" x 36") Random Panel*



457mm x 457mm (18" x 18")



305mm x 457mm (12" x 18")



457mm x 610mm (18" x 24")



Knight Tile at a glance

305mm x 305mm (12" x 12")

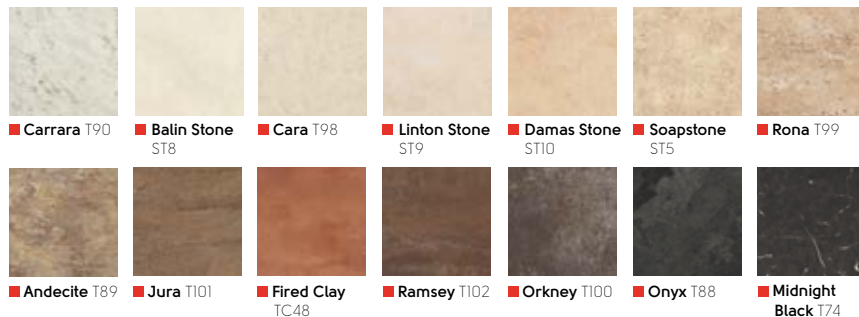

305mm x 457mm (12" x 18")

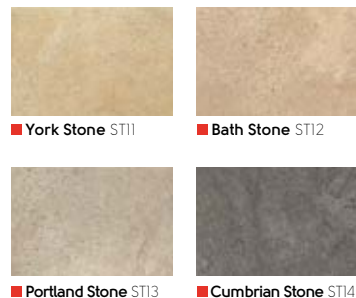

Karndean LooseLay Wood at a glance

Series One

1050mm x 250mm (41.3" x 9.85")



■ Country Oak LLP92



■ Antique Timber LLP106



■ Traditional Oak LLP101



■ Heritage Oak LLP102



■ Vintage Timber LLP105



■ Rustic Timber LLP104



■ Weathered Timber LLP103

Series Two

1050mm x 250mm (41.3" x 9.85")



■ Ashland LLP95



■ Winchester LLP97



■ Newport LLP94



■ Salem LLP96



■ Hudson LLP99



■ Dover LLP93

Series Three

1050mm x 250mm (41.3" x 9.85")



■ Cambridge LLP113



■ Burlington LLP110



■ Providence LLP108



■ Hartford LLP112



■ Stamford LLP109



■ Boston LLP111

Karndean LooseLay Stone at a glance

Series One

500mm x 610mm (19.7" x 24")



■ Indiana LLT202



■ Colorado LLT201



■ Arizona LLT200



■ Madison LLT203

Series Two

500mm x 610mm (19.7" x 24")



■ Georgia LLT206



■ Texas LLT207

Karndean LooseLay Textile at a glance

Series Two

500mm x 610mm (19.7" x 24")



■ Pennsylvania LLT204



■ Nevada LLT205

Cleaning and maintaining your Karndean floor

Karndean Designflooring is hardwearing and easy to look after. Our enhanced surface treatment helps protect against everyday wear, spills and scuffs. This makes it easier and more environmentally friendly to clean and maintain, giving you peace of mind that your Karndean floor will look great for years to come.

We have a dedicated section on the website with videos which explain how best to look after your Karndean floor and covers lots of frequently asked questions from our customers.

We also have our own Floor Care Kits that you can order from your local retailers including everything you need for a simple cleaning routine.



Inside your Floor Care Kit

Regular cleaning with a pH neutral cleaner such as Karndean Clean will help keep your floor at its best.

After time you may want to treat your floor to some extra care. We recommend every six to twelve months, depending on wear, that you strip and refresh your floor using Karndean Remove and Karndean Refresh, to further enhance its look and durability.



- 1 Karndean Clean 750ml
- 2 Karndean Remove 750ml
- 3 Karndean Refresh 750ml
- 4 Floor Protector Pack
- 5 Refresh Pad (soft/white)
- 6 Remove Pad (coarse/white)
- 7 Applicator
- 8 Floor Care Guide



To help protect your Karndean floor we recommend using a Turtle Mat.



How to plan your new floor...

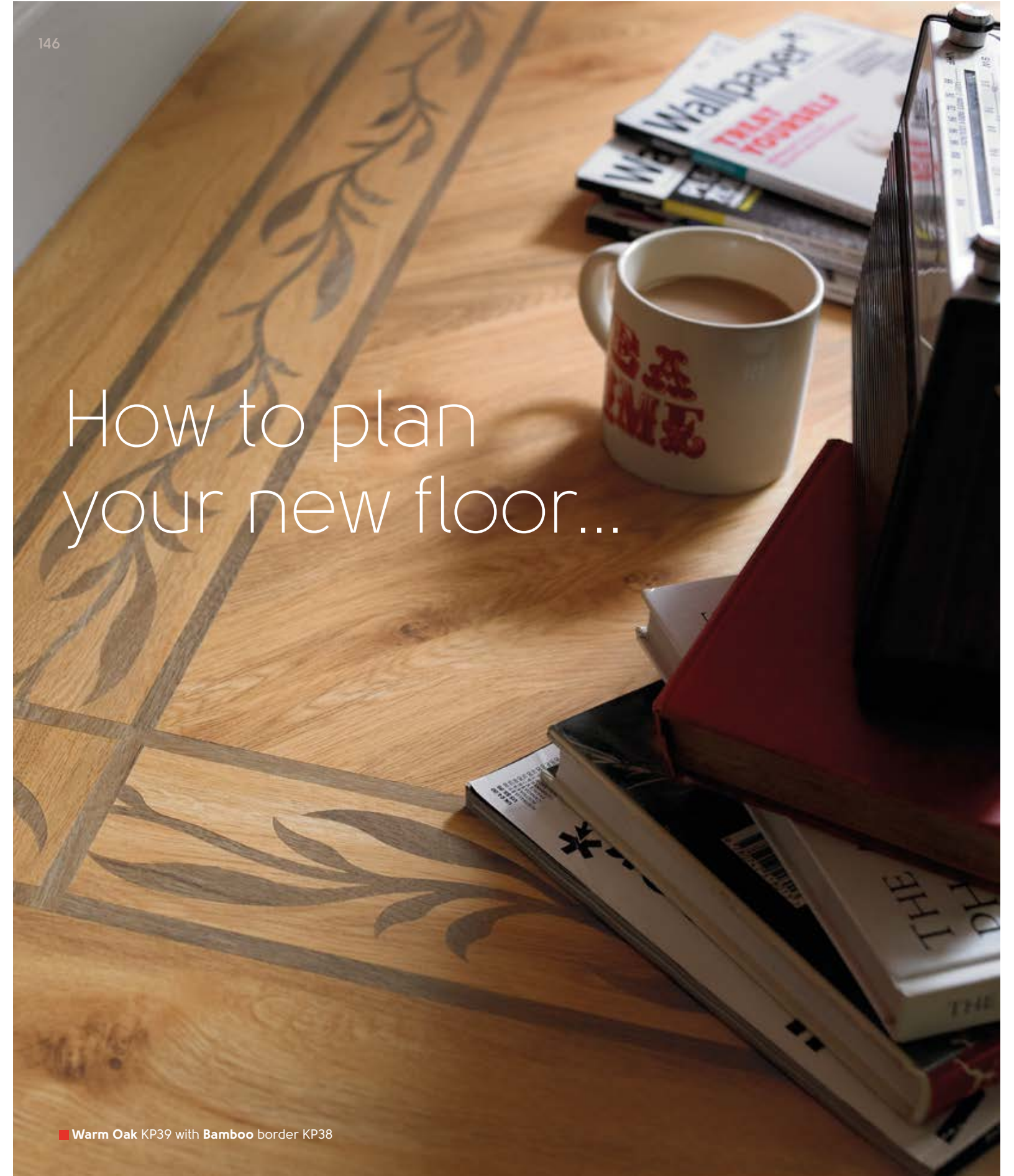

Things to think about...

Our expert staff are here to help you design your floor. Pop in to see your local retailer or visit our showroom in Evesham where you can see over 500m² of Karndean Designflooring!

Helpful hints and tips to help you choose your Karndean floor.

1. Which room in your home do you need flooring for?
2. What style suits your home - classic, contemporary, traditional?
3. Choose your effect - Wood or Stone?
4. What colours will suit your space?
Circle the ones you like on the 'at a glance' pages 140-144. Use pictures, cuttings or swatches of colours and designs you like to help you choose.
5. Have you thought about finishing touches? For decorative borders or strips, see pages 110-121.

Useful notes

Draw a sketch of the shape of your room with rough measurements to take to your retailer. They will visit your home as part of the service, to take accurate measurements and give expert advice.

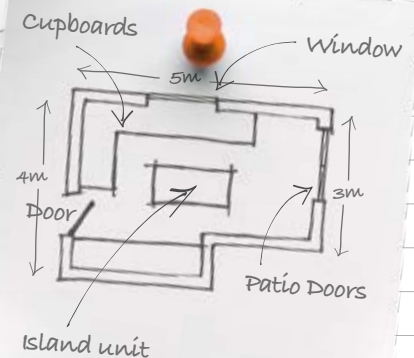



Visit us online at www.karndean.com
where you can:

Find your nearest recommended retailer

Use our online search facility to find your nearest **Karndean Designflooring** recommended retailer. Leave your details for a retailer to contact you for a free measure and quote.



Order samples

If you need some extra help selecting the best colour for your room, why not order some colour chips? These are small samples designed to help you pick which product is right for you.



Try our Floorstyle tool



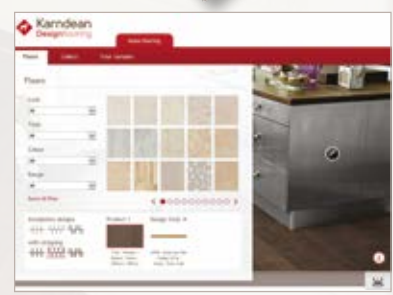

We have developed a great tool which allows you to pick a room and see what different floors will look like. It's really easy to use and will allow you to create your perfect Designflooring combination.



Sign up for our e-newsletter

We'd love to keep in touch with you. To receive our email communications sign up online today at www.karndean.com

Keep up-to-date with us:

-  Follow us on Twitter [@karndeanfloors](https://twitter.com/karndeanfloors)
-  Like us on Facebook [karndeandesignflooring](https://www.facebook.com/karndeandesignflooring)
-  Follow our boards on Pinterest [karndeanfloors](https://www.pinterest.com/karndeanfloors)
-  See what we've been up to in our blog www.karndeanblog.com

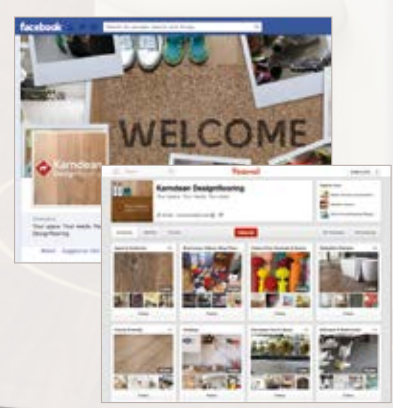

Our new App lets you view any Designflooring floor in your own home

With so many products to choose from, it can be difficult to decide which colours and formats you like. We've created an augmented reality app for iPad and iPhone which allows you to project any of our products onto your floor at home - without even leaving the house!

 Search for 'Karndean' in the App Store.

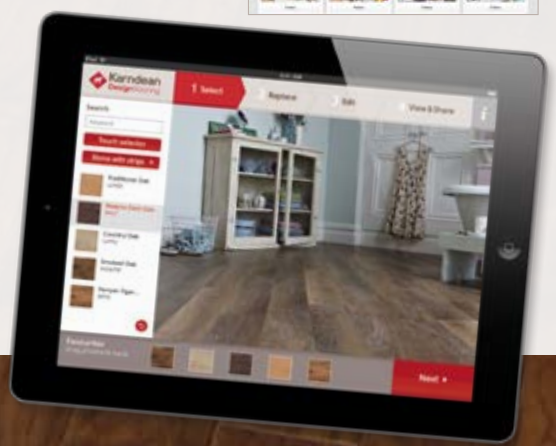



Visit our showroom in Evesham...

Based at our headquarters in the beautiful Vale of Evesham, we always have the latest products on display, with over 500m² of ideas and designs to inspire you.

As well as seeing the full range of **Karndean Designflooring**, you can speak to our trained advisors, use our design tables to try out your design ideas and take away full sized samples with you. We even have a children's play area if you want to bring them along on your visit.

Opening times:

Monday - Friday

9am - 6pm

Saturday

9am - 5pm

Sundays and Bank Holidays

10am - 4pm

The showroom will be closed:

Easter Sunday

Christmas Day

Boxing Day

New Year's Day



Contact us...

Karndean Designflooring
Crab Apple Way
Evesham
Worcestershire
WR11 1GP

Call us on:
01386 820100

Email us:
info@karndean.co.uk
www.karndean.com/contact

Calls may be recorded for training and quality purposes.

Colour & Pattern Reproduction

We are careful to make sure our brochures are accurate and printed to very high standards, but photography and printing cannot always create a perfect representation of our products. For this reason we strongly recommend that you look at a sample of any product you are considering before placing your order.

All of our products are inspired by things we have seen in the natural world and just like variation in colour and detail is part of the beauty of nature, it is also a feature of some of our designs. This means that with some of our products you will see natural variation when your floor is laid. If in doubt, ask your retailer to show you a larger sample of the product.

We love developing new ideas and improving our existing designs. Part of our policy of continuous improvement means that we may add, change or withdraw products from our ranges. We hate to disappoint and will always try to work with you to find an alternative design that you love so much.

Karndean Designflooring owns all their designs and are protected by copyright.

Use our virtual
floor fitting app to:



Karndean
Designflooring

Help you choose the
perfect Karndean floor
for your room

Change the direction that
the floor is laid

Save and share your
favourites



View a Karndean floor in your home today:

- 1 Download our virtual floor fitting app to your iPhone or iPad. Search 'Karndean' in the App Store.
- 2 Put me on the floor with the arrow going in the direction you want the planks or tiles to run.
- 3 Follow the app's on-screen prompts and you'll be on your way to viewing our full catalogue of floors in your home today. You can also share your favourites with friends and family by email or on Facebook and Twitter.

