



Account Number

## UK Trade Price List

### 1st October 2019

All Prices exclude VAT

3% increase on Easyshims.



Decorative Pipe Covers – page 27 – Available October

Premier DoubleZ 13 for thicker carpets – page 37

Premier Single 13 for thicker carpets – page 47

Premier Inlays - page 69

Premier Floating Matwells – page 89

Ali Top Nose 7-8mm laminate to carpeted stair – page 91

Ali LVT Wrap Nosing – Installing floors in our trims – page 95 – Available October

Ali Bendybull Nosing – Installing floors in our trims – page 97 – Available October

Ali LVT Tramline Transition – Installing floors in our trims – page 99

Ali LVT TramlineZ – Installing floors in our trims – page 101 – Available November

Ali LVT Tramline Reducer – Installing floors in our trims – page 103 – Available November

Ali LVT Tramline End Profile – Installing floors in our trims – page 105

Ali Pipe Covers – Installing floors in our trims – page 107 – Available November

G6 chopped up 150mm gripper – page 111 – Available November

Premier Trims available at 100cm with a 10% surcharge.

### Stairrods (UK) Ltd.

Unit 6, Park Road North Ind. Est.,

Blackhill, Consett, Co. Durham DH8 5UN

Tel: +44 (0) 1207 591176

Fax: +44 (0) 1207 591911

Email: [sales@stairrods.co.uk](mailto:sales@stairrods.co.uk)

[www.stairrods.co.uk](http://www.stairrods.co.uk)

# Contents



## Stair Rods

Page 3

5	Royale
7	Eastern Promise
9	Crystal
11	Premier
13	Country
15	Vision
17	Tudor
19	Blacksmith
21	Jubilee
	Homepride





## Accessories

23	Victorian Stair Clips
25	Skiffer
26	Easystuds
27	 Decorative Pipe Covers

## Easyshims



29	Easyshims
31	Easychocks & Easywedges

## Premier Trims

33	DoubleZ™4
35	DoubleZ™9
37	 DoubleZ™13
39	Slim D
41	Slim Z
43	Single 4
45	Single 9
47	 Single 13
49	Square
51	Posh
53	Covers
55	Euro Cover
57	Floating Euro Cover
59	Vinyl Edges
61	Two-Way Ramps
63	Ramps
65	Carpet Ramp
67	Dividers
69	 Inlays
71	LVT Square Cap
73	LVT Bevel Cap
75	LVT Nosing (no bull)
77	LVT Nosing (full bull)
79	Bendy Bull
81	Lips
83	Ts
85	Little Nose
87	LVT Matwell (non floating)
89	 LVT Matwell (floating)



## Ali Trims

- 91  Ali Top Nose
- 93 Installing floors in our trims
- 95  Ali Wrap Nosing
- 97  Ali Bendybull Nosing
- 99  Ali Tramline Transition
- 101  Ali TramlineZ
- 103  Ali Tramline Reducers
- 105  Ali Tramline End Profile
- 107  Ali Pipe Covers

## Carpet Edging

- 109 Easybind

## Gripper

- 111  Geordie Gripper & 6" Chopped up Gripper

# Royale Stair Rods



- Available for runner and fully fitted carpets.
- Three finial designs: Beaumont, Louis, Vue.
- Ten finishes: Antique Brass, Antique Bronze, Black, Brass, Brushed Chrome, Chrome, Pewter, Polished Nickel, Satin Brass, Satin Nickel.
- All finial designs are available in all colours in any combination.

## Royale Prices

Hollow Triangular Rod	Runner	Fully Fitted
For any length up to 36" (91.5cm), thereafter add 55p/inch (2.5cm)	£25.46	£22.72

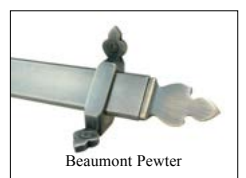



# Technical

4

## **The Product**

- The Royale range of stair rods are available for either a runner carpet or fully fitted.
- The Royale range are made to measure, see below for measuring guidelines.

## **Royale Stair Rod For Carpet Runner.**

- We recommend that you add 6 inches (15cm) to the width of your carpet and use this measurement to give you the tip to tip length of the stair rod.

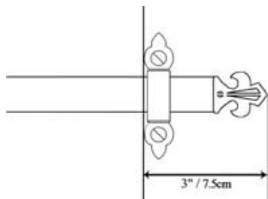

- Our standard runner bracket clearance is 10mm.

ANY QUESTIONS  
Please call 01207 591176 For friendly expert advice.

## **Royale Rod For Fully Fitted Carpet.**

- Depending on the width of the stair we recommend that you leave a 1 to 2 inch (2.5 to 5cm) gap between the stringboard and the tip of the rod at both sides of the staircase.

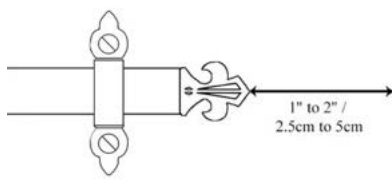

## **Fitting Rods To Stair.**

- Both runner and fully fitted brackets are supplied with number 6 screws and you must drill a pilot hole before fixing the brackets to the stair. For softwood create a 2.5mm pilot hole and for hardwood create a 3mm hole. A clearance hole of 4mm should be drilled to accommodate the screw shank. Remember to set your power drill on a low torque setting to avoid breaking the screws. For fully fitted carpets the supplied bracket sits on top of the rod and screws fix it through the carpet.

## **Care and Maintenance**

- We recommend using a damp cloth to keep the rods clean, any household cleaners used to clean the wood and paint work of the staircase should be applied to the cloth and not directly onto the surface of the stair, as over spray can cause a speckled tarnish on the rods. If any liquids are inadvertently spilt on the stair rods they should be cleaned immediately with a damp cloth and dried with a clean cloth.

# Eastern Promise Stair Rods



- Available in three rod styles: Plain, Reeded and Spiral, for runner and fully fitted carpets.
- Three finial designs: Dubai, Cairo, and Dune.
- Ten finishes: Antique Brass, Antique Bronze, Black, Brass, Brushed Chrome, Chrome, Pewter, Polished Nickel, Satin Brass and Satin Nickel.
- All finial designs are available in all colours and rod styles in any combination.
- Spiral rod only available up to 43" on this range.

## Eastern Promise Prices

Hollow 5/8" Rod	Runner	Fully Fitted
<b>PLAIN ROD</b> 5/8" (16mm). For any length up to 36" (91.5cm), thereafter add 31p/inch (2.5cm)	£21.55	£18.87
<b>SPIRAL OR REEDED</b> 5/8" (16mm). For any length up to 36" (91.5cm), thereafter add 31p/inch (2.5cm)	£23.21	£21.04



Cairo Polished Brass Plain



Dubai Satin Brass Reeded



Dune Antique Spiral



Dubai Antique Bronze Plain



Dune Chrome Reeded



Cairo Brushed Chrome Spiral

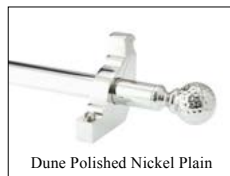

Dune Polished Nickel Plain

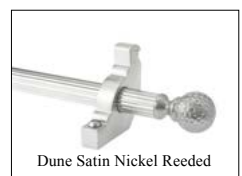

Dune Satin Nickel Reeded



Cairo Black Spiral

Fully Fitted



Dubai Pewter Plain



## **The Product**

- The Eastern Promise range of stair rods are available for either a runner carpet or fully fitted.
- The Eastern Promise range are made to measure, see below for measuring guidelines.

### **Eastern Promise Rod For Fully Fitted Carpet.**

- We recommend that you leave a 2 inch (5cm) gap between the stringboard and the tip of the rod at both sides of the staircase. The Eastern Promise range are made to measure, see below for measuring guidelines.

### **Eastern Promise Stair Rod For Carpet Runner.**

- We recommend that you add 6 inches (15cm) when choosing the Cairo or Dubai finial, to the width of your carpet and use this measurement to give you the tip to tip length of the stair rod. If choosing the Dune finial add 5 inches.  
**NOTE: Tip to tip measurement includes the finials.**

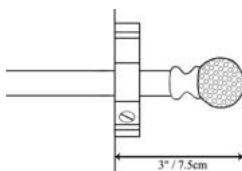

- Our standard runner bracket for this range has a clearance of 16mm however if you have either a deep pile carpet or thin carpet please call for advice.

ANY QUESTIONS  
Please call 01207 591176 For friendly expert advice.

### **Eastern Promise Rod For Fully Fitted Carpet.**

- Depending on the width of the stair we recommend that you leave a 1 to 2 inch (2.5 to 5cm) gap between the stringboard and the tip of the rod at both sides of the staircase.

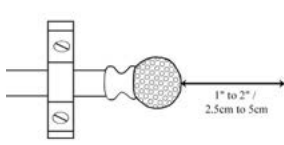

## **Prepare Hinge Brackets For fitting**

- The brackets for runner carpets are hinged and consist of a bottom and top section and cannot be mixed with the top or bottom of other brackets. To fit the brackets the top and bottom must be separated to allow access to the screw holes. This requires little effort and is accomplished by removing the dome head screw and placing your thumbs on the hinge part of the bracket and first two fingers on the inside of the top and bottom and gently ease open the bracket. This will loosen the hinge and allow you to slide them apart.

## **Fitting Rods To Stair.**

- Both runner and fully fitted brackets are supplied with number 6 screws and you must drill a pilot hole before fixing the brackets to the stair. For softwood create a 2.5mm pilot hole and for hardwood create a 3mm hole. A clearance hole of 4mm should be drilled to accommodate the screw shank. Remember to set your power drill on a low torque setting to avoid breaking the screws. With the hinged bracket separated fit the bottom half to the stair and put the rod in place then re fit the top half of the bracket by sliding the two half together, finally close with the dome head screw. For fully fitted carpets the supplied bracket sits on top of the rod and screws fix it through the carpet.

## **Care and Maintenance**

- We recommend using a damp cloth to keep the rods clean, any household cleaners used to clean the wood and paint work of the staircase should be applied to the cloth and not directly onto the surface of the stair, as over spray can cause a speckled tarnish on the rods. If any liquids are inadvertently spilt on the stair rods they should be cleaned immediately with a damp cloth and dried with a clean cloth.

# Crystal Stair Rods



- Available in three rod styles: Plain, Reeded and Spiral, for runner and fully fitted carpets.
- Four crystal colours: Amber, Rainbow, Rose, Sky.
- Ten finishes: Antique Brass, Antique Bronze, Black, Brass, Brushed Chrome, Chrome, Pewter, Polished Nickel, Satin Brass and Satin Nickel.
- All finial designs are available in all colours and diameters in any combination.
- Spiral rod only available up to 42" on this range.

## Crystal Prices

Hollow 1/2" Rod	Runner	Fully Fitted
<b>PLAIN ROD</b> 1/2" (12mm). For any length up to 36" (91.5cm), thereafter add 25p/inch (2.5cm)	£13.94	£13.29
<b>SPIRAL OR REEDED</b> 1/2" (12mm). For any length up to 36" (91.5cm), thereafter add 25p/inch (2.5cm)	£16.06	£15.41

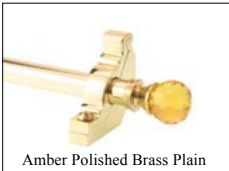

Amber Polished Brass Plain



Rainbow Satin Brass Reeded



Rose Antique Brass Spiral



Sky Antique Bronze Sky

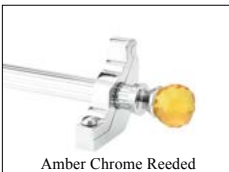

Amber Chrome Reeded

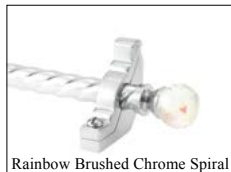

Rainbow Brushed Chrome Spiral



Rose Polished Nickel Plain



Sky Satin Nickel Reeded



Rainbow Black Plain



Fully Fitted



Amber Pewter Spiral



## **The Product**

- The Crystal range of stair rods are available for either a runner carpet or fully fitted.
- The Crystal range are made to measure, see below for measuring guidelines.

## **Crystal Stair Rod For Carpet Runner.**

- We recommend that you add 4 inches (10cm) to the width of your carpet and use this measurement to give you the tip to tip length of the stair rod. **NOTE: Tip to tip measurement includes the finials.**

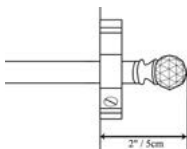

- Our standard runner bracket clearance is 14mm however if you have a deep pile carpet there is the option of using the 'High Clearance' bracket to give you 17mm clearance at a surcharge of £1.66 per rod.

Standard

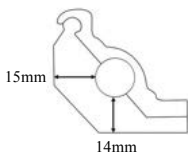

High Clearance

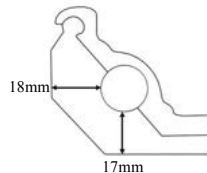

ANY QUESTIONS  
Please call 01207 591176 For friendly expert advice.

## **Crystal Rod For Fully Fitted Carpet.**

- Depending on the width of the stair we recommend that you leave a 1 to 2 inch (2.5 to 5cm) gap between the stringboard and the tip of the rod at both sides of the staircase.

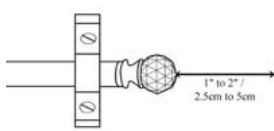

## **Prepare Hinge Brackets For fitting**

- The brackets for runner carpets are hinged and consist of a bottom and top section and cannot be mixed with the top or bottom of other brackets. To fit the brackets the top and bottom must be separated to allow access to the screw holes. This requires little effort and is accomplished by removing the dome head screw and placing your thumbs on the hinge part of the bracket and first two fingers on the inside of the top and bottom and gently ease open the bracket. This will loosen the hinge and allow you to slide them apart.

## **Fitting Rods To Stair.**

- Both runner and fully fitted brackets are supplied with number 6 screws and you must drill a pilot hole before fixing the brackets to the stair. For softwood create a 2.5mm pilot hole and for hardwood create a 3mm hole. A clearance hole of 4mm should be drilled to accommodate the screw shank. Remember to set your power drill on a low torque setting to avoid breaking the screws. With the hinged bracket separated fit the bottom half to the stair and put the rod in place then re fit the top half of the bracket by sliding the two half together, finally close with the dome head screw. For fully fitted carpets the supplied bracket sits on top of the rod and screws fix it through the carpet.

## **Care and Maintenance**

- We recommend using a damp cloth to keep the rods clean, any household cleaners used to clean the wood and paint work of the staircase should be applied to the cloth and not directly onto the surface of the stair, as over spray can cause a speckled tarnish on the rods. If any liquids are inadvertently spilt on the stair rods they should be cleaned immediately with a damp cloth and dried with a clean cloth.

# Premier Stair Rods



- Available in three diameters: 1/2" (12mm), 5/8" (16mm) and 3/4" (19mm).
- Six finial designs: Balmoral, Chatsworth, Lancaster, Hanover, Windsor and Woburn.
- Standard finishes: Antique Brass, Antique Bronze, Polished Brass and Satin Brass.
- Specialised finishes: Black, Brushed Chrome, Chrome, Pewter, Polished Nickel, and Satin Nickel.
- All finial designs are available in all colours and diameters in any combination.
- Hanover is not available in the 5/8" or 3/4".

## Premier Prices

Solid Core Rods	Runner		Fully Fitted		Fully Fitted Side Fix	
	ST	SP	ST	SP	ST	SP
<b>Finish:</b> ST = Standard SP = Specialised	ST	SP	ST	SP	ST	SP
1/2" (12mm) For any length up to 36" (91.5cm), thereafter add 35p/inch (2.5cm)	£19.79	£23.99	£17.09	£21.09	£12.72	£16.72
5/8" (16mm) For any length up to 36" (91.5cm), thereafter add 49p/inch (2.5cm)	£26.88	£32.13	£23.52	£28.52	£17.47	£22.47
3/4" (19mm) For any length up to 36" (91.5cm), thereafter add 74p/inch (2.5cm)	£38.64	£44.94	N/A	N/A	N/A	N/A

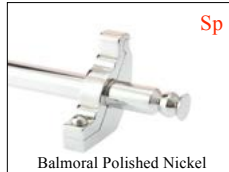
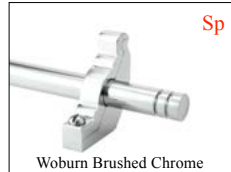
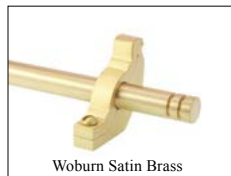



## **The Product**

- The Premier range of stair rods are available for either a runner carpet or fully fitted and in three diameters for runners and two diameters for fully fitted, see facing page for details.
- The Premier range are made to measure, see below for measuring guidelines.

### **Premier Stair Rod For Carpet Runner.**

- For 1/2" rods we recommend that you add 4 inches (10cm) to the width of your carpet and use this measurement to give you the tip to tip length of the stair rod, for 5/8" 5 inches (12.5cm) over and for 3/4" 6 inches (15cm) over.

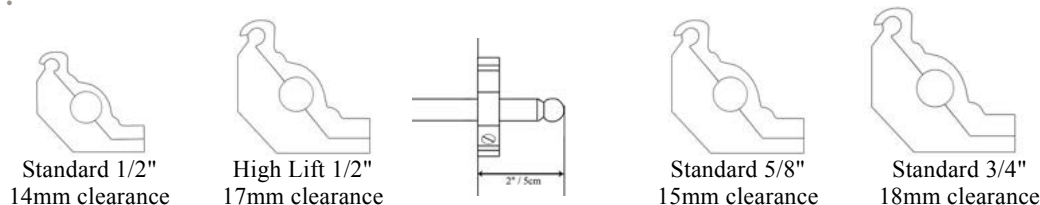

- Our standard runner bracket clearance is 14mm however if you have a deep pile carpet there is the option of using the 'High Clearance' bracket to give you 17mm clearance at a surcharge £1.66 per rod.

ANY QUESTIONS  
Please call 01207 591176 For friendly expert advice.

### **Premier Rod For Fully Fitted Carpet.**

- We recommend that you leave a 1 to 2 inch (2.5 to 5cm) gap between the stringboard and the tip of the rod at both sides of the staircase.

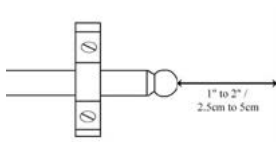

### **Prepare Hinge Brackets For fitting**

- The brackets for runner carpets are hinged and consist of a bottom and top section and cannot be mixed with the top or bottom of other brackets. To fit the brackets the top and bottom must be separated to allow access to the screw holes. This requires little effort and is accomplished by removing the dome head screw and placing your thumbs on the hinge part of the bracket and first two fingers on the inside of the top and bottom and gently ease open the bracket. This will loosen the hinge and allow you to slide them apart.

### **Fitting Rods To Stair.**

- Both runner and fully fitted brackets are supplied with number 6 screws and you must drill a pilot hole before fixing the brackets to the stair. For softwood create a 2.5mm pilot hole and for hardwood create a 3mm hole. A clearance hole of 4mm should be drilled to accommodate the screw shank. Remember to set your power drill on a low torque setting to avoid breaking the screws. With the hinged bracket separated fit the bottom half to the stair and put the rod in place then re fit the top half of the bracket by sliding the two half together, finally close with the dome head screw. For fully fitted carpets the supplied bracket sites on top of the rod and screws fix it through the carpet.

### **Care and Maintenance**

- We recommend using a damp cloth to keep the rods clean, any household cleaners used to clean the wood and paint work of the staircase should be applied to the cloth and not directly onto the surface of the stair, as over spray can cause a speckled tarnish on the rods. If any liquids are inadvertently spilt on the stair rods they should be cleaned immediately with a damp cloth and dried with a clean cloth.



- Available in three rod styles: Plain, Reeded and Spiral, for runner and fully fitted carpets.
- Available in two diameters: 1/2" and 5/8".
- Four finial designs: Arran, Balladeer, Bordeaux and Sherwood.
- Ten finishes: Antique Brass, Antique Bronze, Black, Brass, Brushed Chrome, Chrome, Pewter, Polished Nickel, Satin Brass and Satin Nickel.
- All finial designs are available in all colours and diameters and rod styles in any combination.
- Spiral rod only available up to 42" on this range.

## Country Prices

Hollow Rod	Runner	Fully Fitted	Fully Fitted Side Fix
<b>PLAIN ROD 1/2"</b> (12mm) For any length up to 36" (91.5cm), thereafter add 25p/inch (2.5cm)	£13.94	£13.29	£9.84
<b>SPIRAL OR REEDED 1/2"</b> (12mm) For any length up to 36" (91.5cm), thereafter add 25p/inch (2.5cm)	£16.06	£15.41	£11.96
<b>PLAIN ROD 5/8"</b> (16mm) For any length up to up to 36" (91.5cm), thereafter add 31p/inch (2.5cm)	£20.08	£17.92	£13.61
<b>SPIRAL OR REEDED 5/8"</b> (16mm) For any length up to 36" (91.5cm), thereafter add 31p/inch (2.5cm)	£22.21	£20.08	£15.74

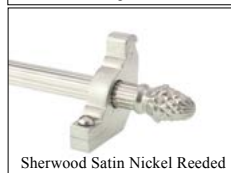
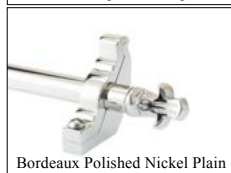
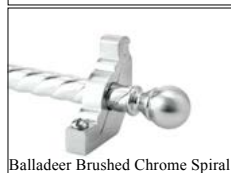



## The Product

- The Country range of stair rods are available for either a runner carpet or fully fitted.
- The Country range are made to measure, see below for measuring guidelines.

## Country Stair Rod For Carpet Runner.

- For 1/2" rods we recommend that you add 4 inches (10cm) to the width of your carpet and use this measurement to give you the tip to tip length of the stair rod and 5/8" 5 inches (12.5cm) over. **NOTE: Tip to tip measurement includes the finials.**

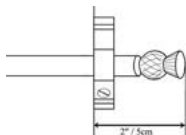

- Our standard runner bracket clearance is 14mm however if you have a deep pile carpet there is the option of using the 'High Clearance' bracket to give you 17mm clearance at a surcharge of £1.66 per rod. If you have a thinner carpet please call for advice.

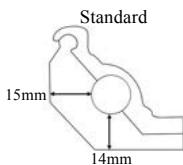

**ANY QUESTIONS**  
Please call 01207 591176 For friendly expert advice.

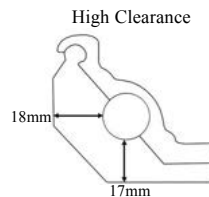

## Country Rod For Fully Fitted Carpet.

- Depending on the width of the stair we recommend that you leave a 1 to 2 inch (2.5 to 5cm) gap between the stringboard and the tip of the rod at both sides of the staircase.

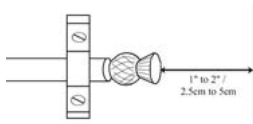

## Prepare Hinge Brackets For fitting

- The brackets for runner carpets are hinged and consist of a bottom and top section and cannot be mixed with the top or bottom of other brackets. To fit the brackets the top and bottom must be separated to allow access to the screw holes. This requires little effort and is accomplished by removing the dome head screw and placing your thumbs on the hinge part of the bracket and first two fingers on the inside of the top and bottom and gently ease open the bracket. This will loosen the hinge and allow you to slide them apart.

## Fitting Rods To Stair.

- Both runner and fully fitted brackets are supplied with number 6 screws and you must drill a pilot hole before fixing the brackets to the stair. For softwood create a 2.5mm pilot hole and for hardwood create a 3mm hole. A clearance hole of 4mm should be drilled to accommodate the screw shank. Remember to set your power drill on a low torque setting to avoid breaking the screws. With the hinged bracket separated fit the bottom half to the stair and put the rod in place then re fit the top half of the bracket by sliding the two half together, finally close with the dome head screw. For fully fitted carpets the supplied bracket sits on top of the rod and screws fix it through the carpet.

## Care and Maintenance

- We recommend using a damp cloth to keep the rods clean, any household cleaners used to clean the wood and paint work of the staircase should be applied to the cloth and not directly onto the surface of the stair, as over spray can cause a speckled tarnish on the rods. If any liquids are inadvertently spilt on the stair rods they should be cleaned immediately with a damp cloth and dried with a clean cloth.



- Available in three rod styles: Plain, Reeded and Spiral, for runner and fully fitted carpets.
- Three finial designs: Arrow, Piston and Sphere.
- Ten finishes: Antique Brass, Antique Bronze, Black, Brass, Brushed Chrome, Chrome, Pewter, Polished Nickel, Satin Brass and Satin Nickel.
- All finial designs are available in all colours, diameters and rod styles, in any combination.
- Spiral rod only available up to 41.5" on this range.

## Vision Prices

Hollow 1/2" Rod	Runner	Fully Fitted
<b>PLAIN ROD</b> 1/2" (12mm). For any length up to 36" (91.5cm), thereafter add 25p/inch (2.5cm)	£16.06	£14.39
<b>SPIRAL OR REEDED</b> 1/2" (12mm). For any length up to 36" (91.5cm), thereafter add 25p/inch (2.5cm)	£18.18	£16.51



Fully Fitted





## **The Product**

- The Vision range of stair rods are available for either a runner carpet or fully fitted.
- The Vision range are made to measure, see below for measuring guidelines.

## **Vision Stair Rod For Carpet Runner.**

- We recommend that you add 4 inches (10cm) to the width of your carpet and use this measurement to give you the tip to tip length of the stair rod. **NOTE: Tip to tip measurement includes the finials.**

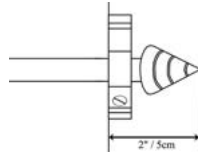

- Our standard runner bracket clearance is 14mm however if you have a deep pile carpet there is the option of using the 'High Clearance' bracket to give you 17mm clearance at a surcharge of £1.66 per rod. If you have a thinner carpet please call for advice.

Standard

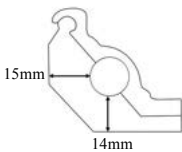

ANY QUESTIONS  
Please call 01207 591176 For friendly expert advice.

High Clearance

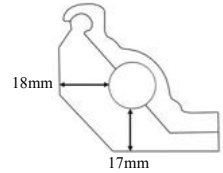

## **Vision Rod For Fully Fitted Carpet.**

- Depending on the width of the stair we recommend that you leave a 1 to 2 inch (2.5 to 5cm) gap between the stringboard and the tip of the rod at both sides of the staircase.

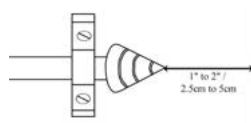

## **Prepare Hinge Brackets For fitting**

- The brackets for runner carpets are hinged and consist of a bottom and top section and cannot be mixed with the top or bottom of other brackets. To fit the brackets the top and bottom must be separated to allow access to the screw holes. This requires little effort and is accomplished by removing the dome head screw and placing your thumbs on the hinge part of the bracket and first two fingers on the inside of the top and bottom and gently ease open the bracket. This will loosen the hinge and allow you to slide them apart.

## **Fitting Rods To Stair.**

- Both runner and fully fitted brackets are supplied with number 6 screws and you must drill a pilot hole before fixing the brackets to the stair. For softwood create a 2.5mm pilot hole and for hardwood create a 3mm hole. A clearance hole of 4mm should be drilled to accommodate the screw shank. Remember to set your power drill on a low torque setting to avoid breaking the screws. With the hinged bracket separated fit the bottom half to the stair and put the rod in place then re fit the top half of the bracket by sliding the two half together, finally close with the dome head screw. For fully fitted carpets the supplied bracket sits on top of the rod and screws fix it through the carpet.

## **Care and Maintenance**

- We recommend using a damp cloth to keep the rods clean, any household cleaners used to clean the wood and paint work of the staircase should be applied to the cloth and not directly onto the surface of the stair, as over spray can cause a speckled tarnish on the rods. If any liquids are inadvertently spilt on the stair rods they should be cleaned immediately with a damp cloth and dried with a clean cloth.

# Tudor Stair Rods

15



- Available for runner and fully fitted carpets.
- Two wood colours: Light and dark.
- Ten finishes: Antique Brass, Antique Bronze, Black, Brass, Brushed Chrome, Chrome, Pewter, Polished Nickel, Satin Brass, Satin Nickel.
- All end detail finishes are available in both dark and light in any combination.

## Tudor Prices

Available in Dark and Light	Runner	Fully Fitted
For any length up to 36" (91.5cm), thereafter add 23p/inch (2.5cm)	£13.56	£12.39

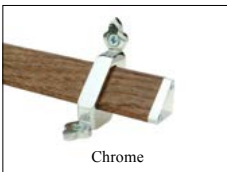

Fully Fitted





## **The Product**

- The Tudor range of stair rods are available for either a runner carpet or fully fitted.
- The Tudor range are made to measure, see below for measuring guidelines.

### **Tudor Stair Rod For Carpet Runner.**

- We recommend that you add 4 inches (10cm) to the width of your carpet and use this measurement to give you the tip length of the stair rod.

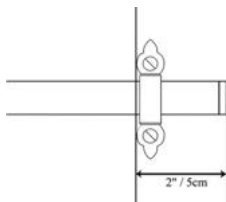

- Our standard runner bracket clearance is 10mm however if you have a deep pile carpet there is the option of using the 'Spacers' to give you more clearance. Please call for advice.

ANY QUESTIONS  
Please call 01207 591176 For friendly expert advice.

### **Tudor Rod For Fully Fitted Carpet.**

- Depending on the width of the stair we recommend that you leave a 1 to 2 inch (2.5 to 5cm) gap between the stringboard and the tip of the rod at both sides of the staircase.

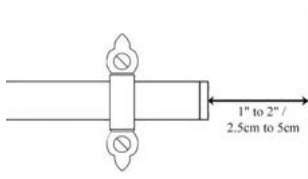

### **Fitting Rods To Stair.**

- Both runner and fully fitted brackets are supplied with number 6 screws and you must drill a pilot hole before fixing the brackets to the stair. For softwood create a 2.5mm pilot hole and for hardwood create a 3mm hole. A clearance hole of 4mm should be drilled to accommodate the screw shank. Remember to set your power drill on a low torque setting to avoid breaking the screws. For fully fitted carpets the supplied bracket sits on top of the rod and screws fix it through the carpet.

### **Care and Maintenance**

- We recommend using a damp cloth to keep the rods clean, any household cleaners used to clean the wood and paint work of the staircase should be applied to the cloth and not directly onto the surface of the stair, as over spray can cause a speckled effect on the lacquered rods. If any liquids are inadvertently spilt on the stair rods they should be cleaned immediately with a damp cloth and dried with a clean cloth.



- Available for runner and fully fitted carpets. (**Hinged bracket option now available for runner only**)
- Available in Black or Stainless Steel.
- 2 finial designs: Ball and Flat.
- Available in stock lengths (see below).
- Custom sizes available on request.

## Blacksmith Prices

Hand beaten stair rods available in stock lengths only, from 24" (60.9cm) to 48" (121.9cm) in 2" (5.08cm) increments. Available in Black (Standard) and Stainless Steel (Specialised) **Sp**. Hinged bracket option for runner only at the **Same Price**.

Black	24" (60.9cm) to 36" (91.4cm) lengths	£12.84
	38" (106.7cm) to 48" (121.9cm) lengths	£14.07
Stainless Steel <b>Sp</b>	24" (60.9cm) to 36" (91.4cm) lengths	£22.44

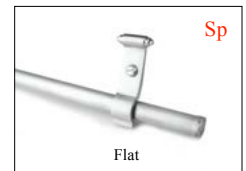



## **The Product**

- The Blacksmith range of stair rods are available for either a runner carpet or fully fitted.
- The Blacksmith range are only available in stock lengths, see facing page.

### **Blacksmith Rod For Fully Fitted Carpet.**

- We recommend that you leave a 1 to 2 inch (5cm) gap between the stringboard and the tip of the rod at both sides of the staircase.

### **Blacksmith Stair Rod For Carpet Runner.**

- We recommend that you add 4 inches (10cm) to the width of your carpet when choosing the Ball or Flat end, then use this measurement to give you the tip to tip length of the stair rod. This is the same for either the Universal or Hinge Bracket option.
- The Universal Blacksmith bracket can be used on both deep pile and thin carpets.
- If choosing the Hinged Bracket option bear in mind the clearance of the bracket is 14mm
- When used on a deep pile carpet the screw thread will be visible when viewed from the side.

ANY QUESTIONS  
Please call 01207 591176 For friendly expert advice.

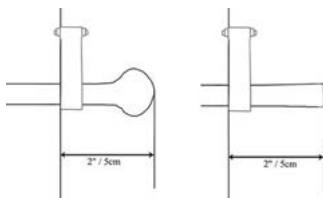

### **Blacksmith Rod For Fully Fitted Carpet.**

- Depending on the width of the stair we recommend that you leave a 1 to 2 inch (2.5 to 5cm) gap between the stringboard and the tip of the rod at both sides of the staircase.

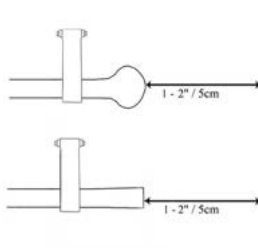

### **Fitting Rods To Stair.**

- Both runner and fully fitted brackets are supplied with number 8 screws and you must drill a pilot hole before fixing the brackets to the stair. For softwood create a 3mm pilot hole and for hardwood create a 3.5mm hole. A clearance hole of 4mm should be drilled to accommodate the screw shank. Remember to set your power drill on a low torque setting to avoid breaking the screws. For fully fitted carpets the bracket sits on top of the rod and screw fixes it through the carpet.

### **Care and Maintenance**

- We recommend using a damp cloth to keep the rods clean, any household cleaners used to clean the wood and paint work of the staircase should be applied to the cloth and not directly onto the surface of the stair, as over spray can cause a speckled tarnish on the rods. If any liquids are inadvertently spilt on the stair rods they should be cleaned immediately with a damp cloth and dried with a clean cloth.

# Jubilee Stair Rods



- Available for runner carpets.
- Eight finishes: Antique, Black, Brass, Satin Nickel, Chrome, Pewter, Bronze and Ivory.

## Jubilee Prices

<b>Option 1</b> For runners up to 27.5" (70cm) wide (stock size)	£4.90
<b>Option 2</b> For runners up to 35" (89cm) wide (stock size)	£5.90
<b>Option 3</b> For runners up to 47.25" (120cm) wide (stock size)	£6.90
<b>Option 4</b> For runners up to 59" (150cm) wide (stock size)	£7.90



Brass



Antique



Bronze



Chrome



Satin Nickel



Ivory



Black



Pewter





## **The Product**

- The Jubilee range of stair rods are available for runner carpets only.
- The Jubilee range are available in four option sizes. See facing page for details
- Our Jubilee runner bracket clearance is 14mm

**Option 1**

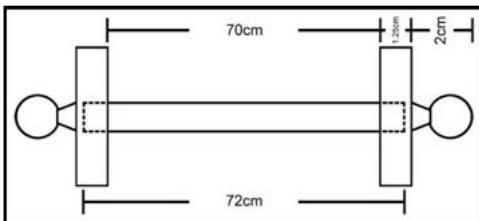

**Option 2**

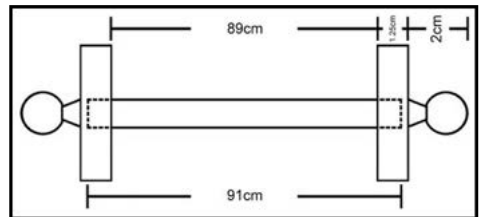

**Option 3**

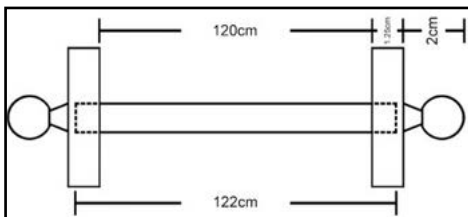

**Option 4**

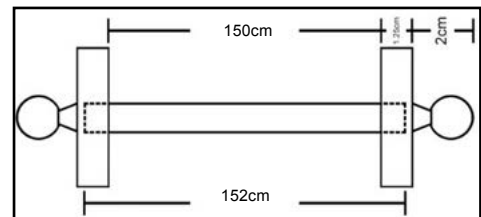

ANY QUESTIONS  
Please call 01207 591176 For friendly expert advice.

## **Fitting Rods To Stair.**

- The brackets are supplied with number 6 screws and you must drill a pilot hole before fixing the brackets to the stair. For softwood create a 2.5mm pilot hole and for hardwood create a 3mm hole. Remember to set your power drill on a low torque setting to avoid breaking the screws.
- Fit one bracket to the tread and riser then cut the rod to size and put in place. Now fit the second bracket.

## **Cleaning**

- We recommend using a damp cloth to keep the rods clean, any household cleaners used to clean the wood and paint work of the staircase should be applied to the cloth and not directly onto the surface of the stair, as over spray can cause a speckled tarnish on the rods. If any liquids are inadvertently spilt on the stair rods they should be cleaned immediately with a damp cloth and dried with a clean cloth.

# Homepride Stair Rods



- Available for runner carpets and fully fitted carpets.
- Eight finishes: Antique, Black, Brass, Bronze, Satin Nickel, Chrome, Pewter and Ivory.

## Homepride Prices

	Runner	Fully Fitted	Side Fix
<b>Option 1</b> For runners up to 27.5" (70cm) wide (stock size)	£7.72	£7.17	N/A
<b>Option 2</b> For runners up to 35" (89cm) wide (stock size)	£9.72	£9.11	£6.54
<b>Option 3</b> For runners up to 47.25" (120cm) wide (stock size)	£11.72	£11.12	£8.51
<b>Option 4</b> For runners up to 59" (150cm) wide (stock size)	£13.72	N/A	N/A

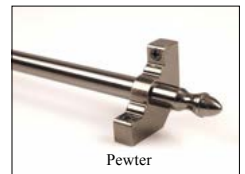



## **The Product**

- The Homepride range of stair rods are available for runner and fully fitted carpets.
- The Homepride range are available in four option sizes. See facing page for details
- Our Homepride runner bracket clearance is 14mm

### **Option 1**

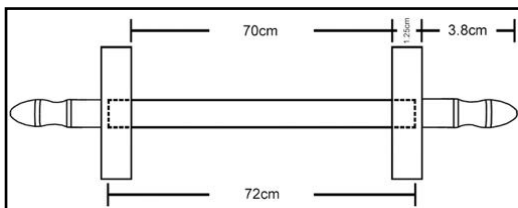

### **Option 2**

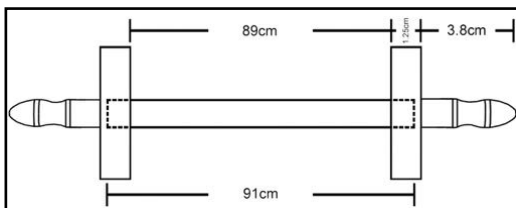

### **Option 3**

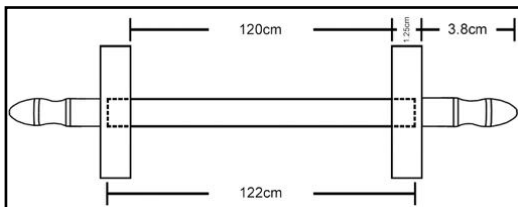

### **Option 4**

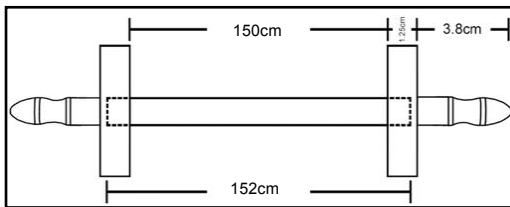

**ANY QUESTIONS**  
Please call 01207 591176 For friendly expert advice.

## **Homepride Rod For Runner Carpet.**

- The brackets are supplied with number 6 screws and you must drill a pilot hole before fixing the brackets to the stair. For softwood create a 2.5mm pilot hole and for hardwood create a 3mm hole. Remember to set your power drill on a low torque setting to avoid breaking the screws.
- Fit one bracket to the tread and riser then cut the rod to size and put in place. Now fit the second bracket.

## **Homepride Rod For Fully Fitted Carpet.**

- Depending on the width of the stair we recommend that you leave a 1 to 2 inch (2.5 to 5cm) gap between the stringboard and the tip of the rod at both sides of the staircase.

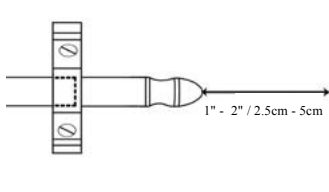

## **Cleaning**

- We recommend using a damp cloth to keep the rods clean, any household cleaners used to clean the wood and paint work of the staircase should be applied to the cloth and not directly onto the surface of the stair, as over spray can cause a speckled tarnish on the rods. If any liquids are inadvertently spilt on the stair rods they should be cleaned immediately with a damp cloth and dried with a clean cloth.

# Victorian Stair Clips



- Available in Brass, Antique Brass, Chrome, Satin Nickel, Pewter, Satin Brass, Bronze and Black.
- Sold in pairs.

## Victorian Stair Clip Prices

Available in Brass, Antique Brass, Chrome, Satin Nickel, Pewter, Satin Brass, Bronze and Black.

Per Pair

£7.95

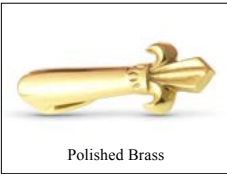

Polished Brass

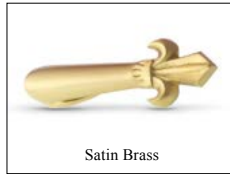

Satin Brass



Antique Brass

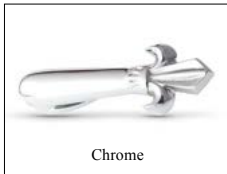

Chrome



Satin Nickel



Black



Brushed Chrome



Pewter



Polished Nickel



Bronze



## **The Product**

- The Victorian Stair Clip for runner carpets only.
- The Victorian Stair Clip Range are sold as a pair.

## **Prepare Hinge Brackets For fitting**

- The Victorian Stair Clip fixing plate needs to be pivoted at 90 degrees to the main body of the clip. This gives access to the screw holes.



ANY QUESTIONS  
Please call 01207 591176 For friendly expert advice.

## **Fitting Rods To Stair.**

- Fitting the Victorian Stair Clip is easier if done before fitting the carpet.
- First mark the width of the carpet where the tread meets the riser, use this mark to line up the inner edge of the fixing plate with where the edge of the carpet will be.
- Next measure the height of the carpet and underlay, this will give you a guide to ensure you fit the Victorian Stair Clip level.
- Now line the bottom surface of the Clip with the carpet height mark and have the fixing plate perfectly level. Mark with a pencil around the fixing plate.
- Pivot the fixing plate and line it up with the pencil mark and mark the holes.
- You can now make a template using the hole positions and carpet width and height marks to give the position of the hole on the remaining stairs.
- Victorian Stair Clips are supplied with number 6 screws and you must drill a pilot hole before fixing the brackets to the stair. For softwood create a 2.5mm pilot hole and for hardwood create a 3mm hole. Remember to set your power drill on a low torque setting to avoid breaking the screws.



## **Care and Maintenance**

- We recommend using a damp cloth to keep the rods clean, any household cleaners used to clean the wood and paint work of the staircase should be applied to the cloth and not directly onto the surface of the stair, as over spray can cause a speckled tarnish on the rods. If any liquids are inadvertently spilt on the stair rods they should be cleaned immediately with a damp cloth and dried with a clean cloth.



- Available in: Polished Brass, Antique Brass, Satin Brass, Chrome, Satin Nickel, Pewter and Black.
- Minimum order of 6 in any combination.

## Skiffer Prices

<b>75mm</b>	£5.20 each
<b>107mm</b>	£5.74 each
<b>134mm</b>	£6.58 each



Carriage paid on 6 and over. Less than 6, add £7.50 for carriage, unless ordered with other items.



- Features a specially designed 19mm serrated stud to fix through even the thickest of carpets.
- Available in: Brass, Bronze, Chrome, Satin Nickel and Black/Pewter.

## Easystud Prices

Available in Brass, Bronze, Chrome, Satin Nickel, and Black/Pewter,

1 Jar (100 approx)	£11.94
1 Jar (250 approx)	£29.83

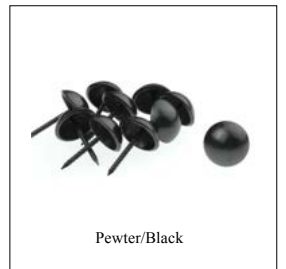
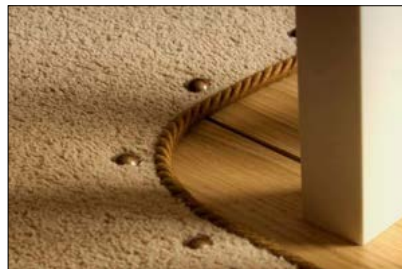
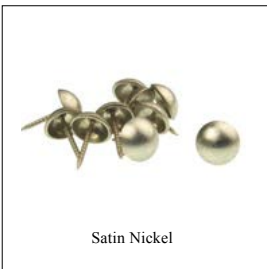
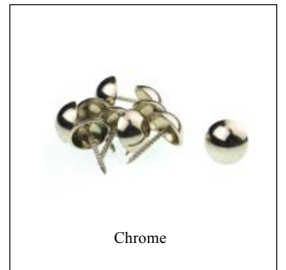
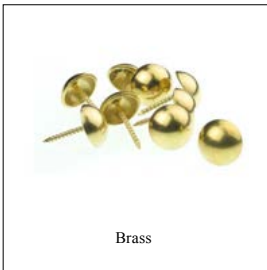

Carriage paid on 200 and over. Less than 200, add £7.50 for carriage, unless ordered with other items.



**Available from  
October 2019**

• A selection of attractive metal radiator pipe covers in various designs and colours.

## Decorative Pipe Cover Prices

Profile Type	1 +	16 +	50 +	100 +
<b>Small Deco Pipe Covers</b>	£4.56 Each	£2.56 Each	£2.30 Each	£2.07 Each
<b>Large Deco Pipe Covers</b>	£5.29 Each	£3.29 Each	£2.96 Each	£2.66 Each

Circulus



Quadratum



Solis



Oblongo



Flos



Cordis



Stella

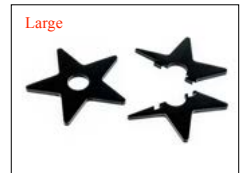



## **The Product**

- The Decorative Radiator Pipe Covers use a base material of zinc alloy for a high-quality installation.

## **Fitting**

- Simply slots together and loose laid.
- Fits a 15mm radiator pipe.

	Minimum Clearance Needed	Maximum Expansion Hole
<b>Cordis</b>	45mm	36mm
<b>Solis</b>	24mm	36mm
<b>Oblongo</b>	31mm	40mm
<b>Flos</b>	25mm	30mm
<b>Quadratum</b>	14mm	42mm
<b>Stella</b>	32mm	32mm
<b>Circulus</b>	14mm	40mm

Minimum Clearance Needed

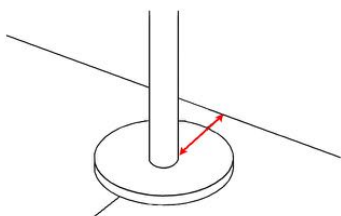

Maximum Expansion Hole

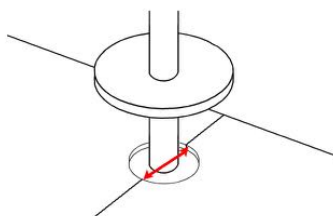



- Fixing your height differences
- Each shim is 36" (91.5cm) wide with an 8" (20cm) ramp.

## Easyshim Prices

	6mm (nominal)	9mm (nominal)	12mm (nominal)	15mm (nominal)
1 pack (10 shims)	£35.57	£38.53	£44.51	£50.48
5 pack (50 shims)	£23.63	£26.59	£32.56	£38.52
10 pack (100 shims)	£21.24	£23.85	£29.23	£34.60

5 and 10 pack prices can be in any combination of shims e.g. 1 pack of 6mm, 1 pack of 9mm, 2 pack of 12mm, 1 pack of 15mm, or 5 packs of 9mm.

## Easyshim Starter Pack Price

Easyshim Starter Pack contains the following: This is sufficient for 8 door ways.  
Easyshims 2 x 6mm, 2 x 9mm, 2 x 12mm and 2 x 15mm.

£45.38

## Height Difference Rough Guide Carpet to Hard Floor

Base Floor to High Hard Floor = Height Difference (HD) rough guide for DoubleZ<sup>TM9</sup> using shims, chocks & underlay

(HD)	Shim	Chock	Base	Gap	Nap	Equals (HD)
16mm	6mm	+ 3mm	+ 1mm	+ 9mm	- 3mm	= 16mm
19mm	9mm	+ 3mm	+ 1mm	+ 9mm	- 3mm	= 19mm
22mm	12mm	+ 3mm	+ 1mm	+ 9mm	- 3mm	= 22mm
25mm	15mm	+ 3mm	+ 1mm	+ 9mm	- 3mm	= 25mm

**A PDF on how to make Side Shims is available for download at [stairrods.co.uk](http://stairrods.co.uk) under the FAQs**



## **Product**

- The Easyshim is the perfect way to raise the level of your carpet if you encounter a height difference.
- Used in a 'Combo' with our Easychocks/MDF spacer to transition a height of up to 25mm or add a lip or a 5mm Carpet Ramp (up to 30mm).

## **Fitting**

- The Easyshims can be either nailed or stuck down.
- Use the rough guide on the facing page to chose the correct 'Combo' for your Carpet to Hard Floor installation.



ANY QUESTIONS  
Please call 01207 591176 For friendly expert advice.

## **See some installation examples below**

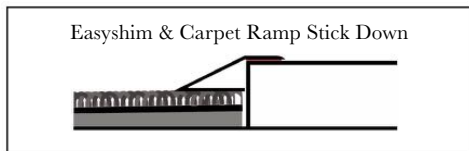
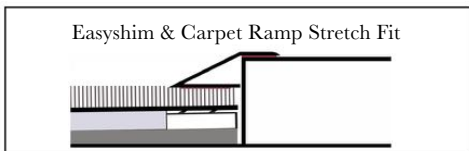
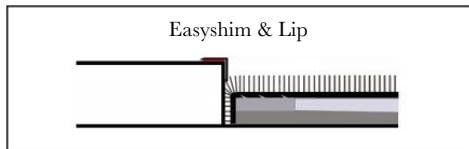
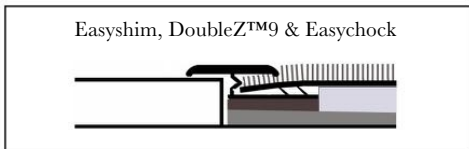
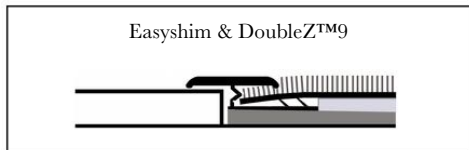
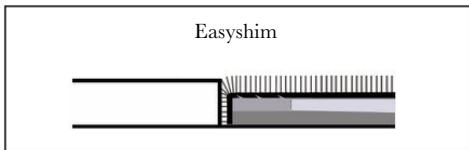



- A convenient 'Raised Base'.
- Ideal when using deep underlay.

## Easychocks & Easywedges Prices

A convenient 'Raised Base' for our DoubleZ™, Z Trim, Slim Z, Square and Single.

	1 Bucket	10 + Buckets
Easychock Bucket (approx 250)	£8.00	£7.11 each
Easywedge Bucket (approx 250)	£6.00	£5.33 each
Easychock Bucket (approx 1000)	£30.00	£28.00 each
Easywedge Bucket (approx 1000)	£22.00	£20.00 each

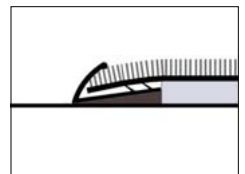
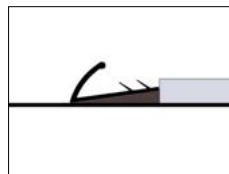
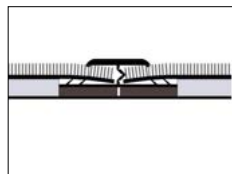
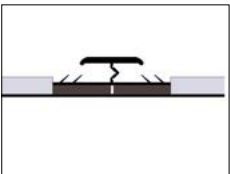



## **Product**

- The Easychocks & Easywedges are a convenient 'Raised Base' for use with our DoubleZ™/ Zbar, Square and Single.
- The Easychocks/MDF Spacer & Easywedges are supplied with every order of DoubleZ™, Square and Single, but are also available to purchase in buckets of 250 and 1000.

## **Fitting**

- The Easychocks can be used to achieve the height required and are supplied in a standard height of 3mm. They should be placed at each end of the door bar and located at the fixing holes then nailed through. It is then easy to slip the remaining Easychocks in place at the remaining fixing points along the door bar.



- The Easywedges can only be used singularly to achieve the height required and are supplied in a standard height of 3mm.. The Easywedges should be placed at each end of the door bar and located at the fixing holes then nailed through. It is then easy to slip the remaining Easychocks in place at the remaining fixing points along the door bar.



ANY QUESTIONS  
Please call 01207 591176 For friendly expert advice.

## **See some installation examples below**

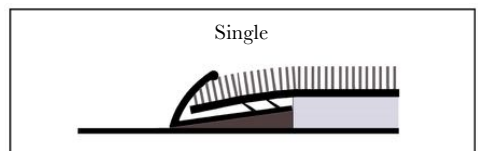
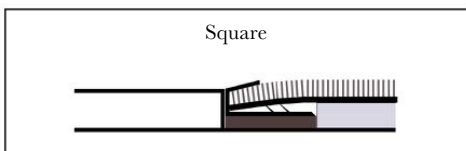
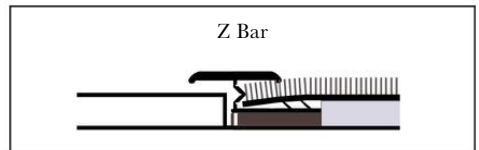
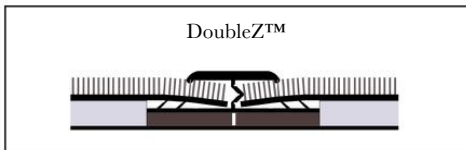

# Premier DoubleZ™ 4



- The DoubleZ™4 is a Double Naplock and Z Trim.
- Use MDF strips to raise the base if required.

**Free MDF Strips  
Supplied**

## DoubleZ™4 Prices

		Individual Price		50 Price (Any Trims)	
Profile Type	Size	Standard	Specialised	Standard	Specialised
	90cm	£15.99	£23.32	£14.39	£20.41
	180cm	£31.98	£46.44	£28.78	£40.82
	270cm	£47.97	£69.66	£43.17	£61.23

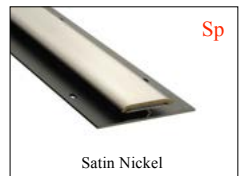

**Carriage paid on 3 and over. Less than 3, add £7.50 for carriage, unless ordered with other items.**



## **Product**

- The Premier DoubleZ4 uses a base material of solid brass for a high-quality installation.
- Available lengths: 90cm, 180cm and 270cm.

## **Fitting**

- The DoubleZ4 is used for thin carpets i.e. flatweaves/mini boucle sisal products or by peeling off one side, it can be used for hard flooring of similar height.
- Includes 3mm MDF spacer 40cm long. Cut in short lengths and place under nail holes to raise base.



- Score along the peel line with a Stanley Knife and peel away with a pair of pliers.
- The DoubleZ bar will 'nap' down if required.
- Use a block of wood wrapped in carpet and then gently hammer down the trim making it level, never at an angle.
- Use the MDF strips provided to raise the base 3mm when used in conjunction with an underlay system.

## **See some installation examples below**

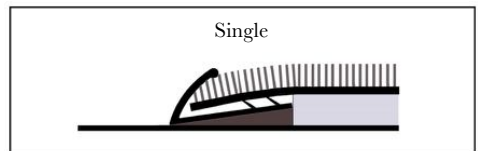
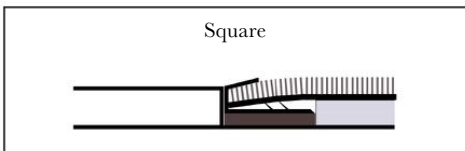
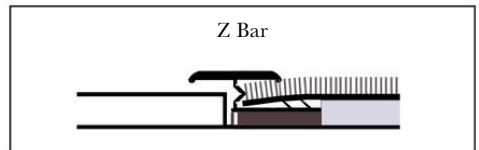
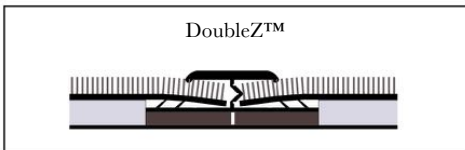

**Cleaning Guide, See page 112**

# Premier DoubleZ™ 9



- The DoubleZ™9 is a Double Naplock and Z Trim.
- Use the MDF strips provided to raise the base.

**Free MDF Strips  
Supplied**

## DoubleZ™9 Prices

		Individual Price		50 Price (Any Trims)	
Profile Type	Size	Standard	Specialised	Standard	Specialised
	90cm	£16.50	£23.83	£14.85	£20.85
	180cm	£33.00	£47.66	£29.70	£41.70
	270cm	£49.40	£71.49	£44.55	£62.55

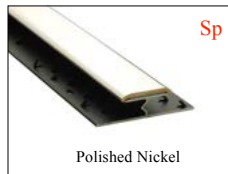
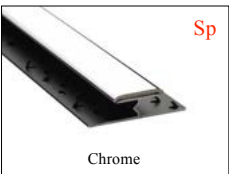

**Carriage paid on 3 and over. Less than 3, add £7.50 for carriage, unless ordered with other items.**



## **Product**

- The Premier DoubleZ9 uses a base material of solid brass for a high-quality installation.
- Available lengths: 90cm, 180cm and 270cm.

## **Fitting**

- The DoubleZ can be used for carpet to carpet or by peeling off one side, it can be used for carpet to a hard floor up to about 13mm in height.
- Includes 3mm MDF spacer 40cm long. Cut in short lengths and place under nail holes to raise base.
- Score along the peel line with a Stanley Knife and peel away with a pair of pliers.



- The DoubleZ bar will 'nap' down about 2-4mm to give the carpet a firm grip on the pins.
- Used as a Z bar, the trim should start a few millimetres above the height of the hard floor to allow a 2-4mm 'nap' down... for higher hard floors (above 13mm) consider the use of Easyshims to raise the carpet.
- Use a block of wood wrapped in carpet and then gently hammer down the trim making it level, never at an angle.
- Use the MDF strips provided to raise the base 3mm to allow optimum hold on the pins.

ANY QUESTIONS  
Please call 01207 591176 For friendly expert advice.

## **See some installation examples below**

Underlay raising base with 3mm MDF



As a Z Bar with 3mm MDF, Pre 'nap'



**Cleaning Guide, See page 112**



- The DoubleZ™ 13 is for use with very thick carpet only.
- The DoubleZ™ 13 is a Double Naplock and a Z Trim.
- Use the MDF strips provided to raise the base.
- **The DoubleZ™ 13 not designed for a 9mm carpet to a 13mm high floor, as the trim will not sit flat or give a firm grip on the pins.**

**Free MDF Strips  
Supplied**

## DoubleZ™13 Prices

Profile Type		Size	Individual Price		50 Price (Any Trims)	
			Standard	Specialised	Standard	Specialised
		90cm	£18.00	£25.33	£16.20	£22.80
		180cm	£36.00	£50.66	£32.40	£45.60
		270cm	£50.40	£75.99	£48.60	£68.40

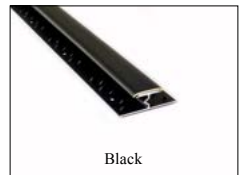
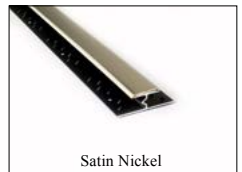

**Carriage paid on 3 and over. Less than 3, add £7.50 for carriage, unless ordered with other items.**



## **Product**

- The Premier DoubleZ13 uses a base material of solid brass for a high-quality installation.
- Available lengths: 90cm, 180cm and 270cm.

## **Fitting**

- The DoubleZ13 can be used for thick carpet to carpet or by peeling off one side, it can be used for thick carpet to a hard floor up to about 13mm in height. **It is not designed for a 9mm carpet to a 13mm high floor as the trim will not sit flat or give a firm grip on the pins.**



- Includes 3mm MDF spacer 40cm long. Cut in short lengths and place under nail holes to raise base.
- Score along the peel line with a Stanley Knife and peel away with a pair of pliers.
- The DoubleZ bar will 'nap' down about 2-4mm to give the carpet a firm grip on the pins.
- Used as a Z bar, the trim should start a few millimetres above the height of the hard floor to allow a 2-4mm 'nap' down. For higher hard floors (above 13mm) consider the use of Easyshims to raise the carpet.
- Use a block of wood wrapped in carpet and then gently hammer down the trim making it level, never at an angle.
- Use the MDF strips provided to raise the base 3mm.

ANY QUESTIONS  
Please call 01207 591176 For friendly expert advice.

## **See some installation examples below**

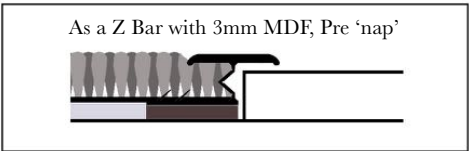
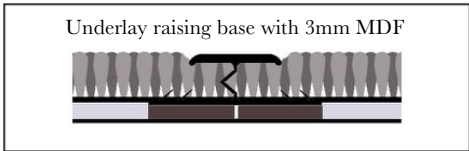

**Cleaning Guide, See page 112**

# Premier Slim D



- The Slim D is a Double Naplock using gripper to raise the base.
- Enables power stretching if required.
- Discreet 16mm top.

## Slim D Prices

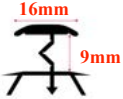
Profile Type		Individual Price		50 Price (Any Trims)	
		Standard	Specialised	Standard	Specialised
	Size				
	90cm	£13.27	£16.46	£11.94	£14.81
	180cm	£26.54	£32.92	£23.88	£29.62
	270cm	£39.81	£49.38	£35.82	£44.43



Carriage paid on 3 and over. Less than 3, add £7.50 for carriage, unless ordered with other items.



## **Product**

- The Premier Slim D uses a base material of solid brass for a high-quality installation.
- Available lengths: 90cm, 180cm and 270cm.

## **Fitting**

- The Slim D is for use with carpet to carpet up to about 12mm in thickness.
- Use the appropriate gripper as specified by the carpet manufacturer.
- See our fitting video on YouTube search Stairrods Slim D.
- Use a block of wood wrapped in carpet and then gently hammer down the trim making it level, never at an angle.

**See an installation example below**

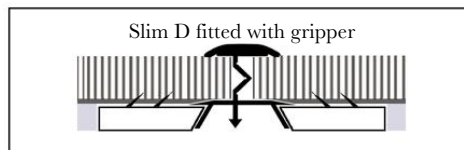

**Cleaning Guide, See page 112**



- The Premier Trim Slim Z is for use with carpet to hard floor with minimal expansion.
- Use MDF Strips to raise the base if required.

## Slim Z Prices

		Individual Price		50 Price (Any Trims)	
Profile Type	Size	Standard	Specialised	Standard	Specialised
	90cm	£15.33	£18.40	£13.80	£16.56
	180cm	£30.66	£36.80	£27.60	£33.12
	270cm	£45.99	£55.20	£41.40	£49.68

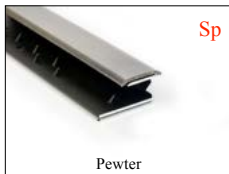
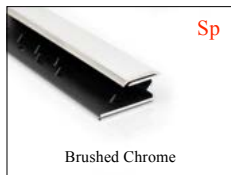

Carriage paid on 3 and over. Less than 3, add £7.50 for carriage, unless ordered with other items.



# Technical

42

## **Product**

- The Premier Slim Z uses a base material of solid brass for a high-quality installation.
- Available lengths: 90cm, 180cm and 270cm.

## **Fitting**

- The Slim Z can be used for carpet to a hard floor with minimal expansion requirement.
- The Slim Z bar will 'nap' down about 2-4mm to give the carpet a firm grip on the pins. Includes 3mm MDF spacer 40cm long. Cut in short lengths and place under nail holes to raise base.
- The trim should start a few millimetres above the height of the hard floor to allow a 2-4mm 'nap' down... for higher hard floors (above 13mm) consider the use of Easyshims to raise the carpet.
- Use a block of wood wrapped in carpet and then gently hammer down the trim making it level, never at an angle.

ANY QUESTIONS

Please call 01207 591176 For friendly expert advice.

**See an installation example below**

Underlay raising the base with 3mm MDF



**Cleaning Guide, See page 112**



- An attractive carpet edging profile.
- To be used with thin stick down carpets where napping down a 9mm Single may prove difficult.

**Free Easywedges Supplied**

## Single 4 Prices

Profile Type	Size	Individual Price		50 Price (Any Trims)	
		Standard	Specialised	Standard	Specialised
	90cm	£12.24	£19.60	£11.02	£17.15
	180cm	£24.48	£39.20	£22.04	£34.30
	270cm	£36.72	£58.80	£33.06	£51.45

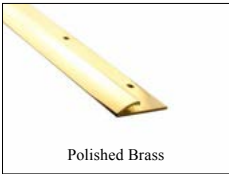

**Carriage paid on 3 and over. Less than 3, add £7.50 for carriage, unless ordered with other items.**



## **Product**

- The Premier Single 4 uses a base material of solid brass for a high-quality installation.
- Available lengths: 90cm, 180cm and 270cm.

## **Fitting**

- The Single 4 is used as a carpet edge for thin carpets i.e. flatweaves/mini boucle sisal products.
- The Single 4 will 'nap' down to give the carpet a firm grip.
- Use a block of wood wrapped in carpet and then gently hammer down.
- The Single 4 is supplied with Easywedges to raise the base for double stick installations.

ANY QUESTIONS  
Please call 01207 591176 For friendly expert advice.

## **See some installation examples below**

Fully adhered



Double stick underlay with Easywedges



LVT Dryback and Latex



**Cleaning Guide, See page 112**



- An attractive carpet edging profile.
- Supplied with Easywedges to raise the base.

**Free Easywedges  
Supplied**

## Single 9 Prices

Profile Type	Size	Individual Price		50 Price (Any Trims)	
		Standard	Specialised	Standard	Specialised
	90cm	£12.75	£20.11	£11.48	£17.60
	180cm	£25.50	£40.22	£22.96	£35.20
	270cm	£38.25	£60.33	£34.44	£52.80

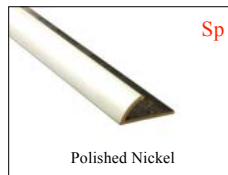
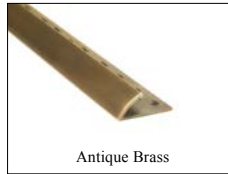
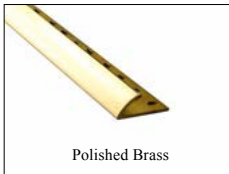

**Carriage paid on 3 and over. Less than 3, add £7.50 for carriage, unless ordered with other items.**



# Technical

46

## **Product**

- The Premier Single 9 uses a base material of solid brass for a high-quality installation.
- Available lengths: 90cm, 180cm and 270cm.

## **Fitting**

- The Single 9 is used as a carpet edge.
- The Single 9 will 'nap' down about 2-4mm to give the carpet a firm grip on the pins.
- Use a block of wood wrapped in carpet and then gently hammer down.
- The Single 9 is supplied with Easywedges to raise the base for thicker underlays placing under the fixing points.

ANY QUESTIONS  
Please call 01207 591176 For friendly expert advice.

**See an installation example below**

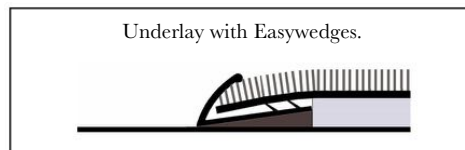

**Cleaning Guide, See page 112**

# Premier Single 13

47



- An attractive carpet edge for thick/ dense pile carpets.
- Supplied with Easywedges to raise the base.

**Free Easywedges  
Supplied**

## Single 13 Prices

Profile Type	Size	Individual Price		50 Price (Any Trims)	
		Standard	Specialised	Standard	Specialised
	90cm	£16.75	£24.11	£15.08	£21.70
	180cm	£33.50	£48.22	£30.16	£43.40
	270cm	£50.25	£72.33	£45.24	£65.10



**Carriage paid on 3 and over. Less than 3, add £7.50 for carriage, unless ordered with other items.**



# Technical

## **Product**

- The Premier Single 13 uses a base material of solid brass for a high-quality installation.
- Available lengths: 90cm, 180cm and 270cm.

## **Fitting**

- The Single 13 is used as a carpet edge.
- The Single 13 will 'nap' down about 2-4mm to give the carpet a firm grip on the pins.
- Use a block of wood wrapped in carpet and then gently hammer down.
- The Single 13 is supplied with Easywedges to raise the base for thicker underlays placing under the fixing points.

ANY QUESTIONS  
Please call 01207 591176 For friendly expert advice.

**See an installation example below**

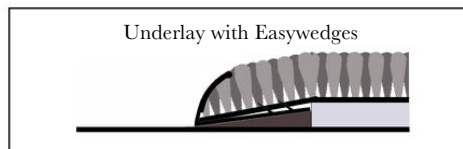

**Cleaning Guide, See page 112**

# Premier Square

49



- A versatile edging profile.
- Can be used for a number of differing installations.
- For butting up to tiles, door surrounds and matwells.
- Use MDF strips to raise the base if required.

**Free MDF strips  
Supplied**

## Square Prices

Profile Type	Size	Individual Price		50 Price (Any Trims)	
		Standard	Specialised	Standard	Specialised
	90cm	£14.25	£21.61	£12.83	£18.91
	180cm	£28.50	£43.22	£25.66	£37.82
	270cm	£42.75	£64.83	£38.49	£56.73

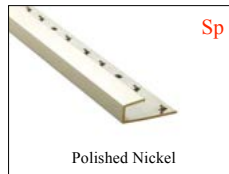
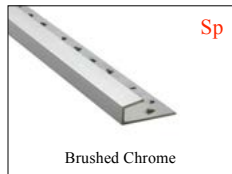

**Carriage paid on 3 and over. Less than 3, add £7.50 for carriage, unless ordered with other items.**



# Technical

50

## **Product**

- The Premier Square uses a base material of solid brass for a high-quality installation.
- Available lengths: 90cm, 180cm and 270cm.

## **Fitting**

- The Square is used as a carpet edge, matwell edge or butting up to non-expanding hard floors.
- The Square is supplied with 3mm MDF strips to raise the base for thicker underlays and height adjustment

ANY QUESTIONS  
Please call 01207 591176 For friendly expert advice.

**See some installation examples below**

Underlay raising the base with 3mm MDF



**Cleaning Guide, See page 112**



- The Premier Posh is a screw down product for almost every transition.
- A truly universal product.
- When fitted, the fixing screws are hidden by the insert.
- Beware of under floor heating.

## Posh Prices

Profile Type	Size	Individual Price		50 Price (Any Trims)	
		Standard	Specialised	Standard	Specialised
 30mm	90cm	£15.70	£23.43	£14.13	£21.09
	180cm	£31.40	£46.86	£28.26	£42.18
	270cm	£47.10	£70.29	£42.39	£63.27
 38mm	90cm	£17.30	£25.03	£15.57	£22.53
	180cm	£34.60	£50.06	£31.14	£45.06
	270cm	£51.90	£75.09	£46.71	£67.59
 55mm	90cm	£22.54	£30.27	£20.29	£27.24
	180cm	£45.08	£60.54	£40.58	£54.48
	270cm	£67.62	£90.81	£60.87	£81.72

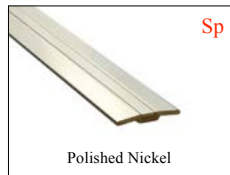
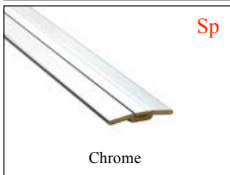

Carriage paid on 3 and over. Less than 3, add £7.50 for carriage, unless ordered with other items.



## **Product**

- The Premier Posh Trim uses a base material of solid brass for a high-quality installation.
- Available lengths: 90cm, 180cm and 270cm.

## **Fitting**

- The Premier Trim Posh 30mm, 38mm and 55mm are a universal trim that can be used for a carpet to carpet, carpet to hard floor and between two hard floors.
- The Premier Trim Posh is a screw down product and the screw heads are then hidden using the stick down inlay.
- When using on hard floor to hard floor with a height difference the Posh 30mm will accommodate up to a 4mm edge, the Posh 38mm up to a 6mm edge and the Posh 55mm up to a 8mm edge.
- Supplied with Spax screws.

ANY QUESTIONS  
Please call 01207 591176 For friendly expert advice.

## **See some installation examples below**

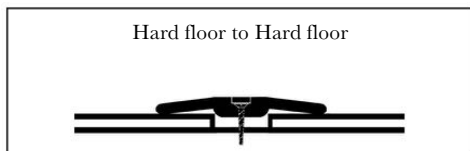
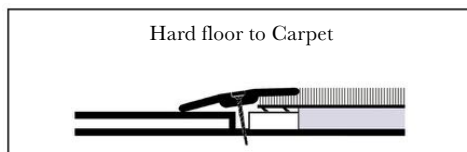
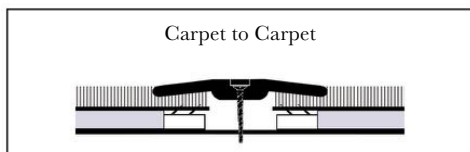

**Cleaning Guide, See page 112**



- The Premier Cover is a screw down product for almost every transition.
- A truly universal product.
- When fitted the fixing screws remain visible.
- Beware of under floor heating.

## Cover Prices

Profile Type	Size	Individual Price		50 Price (Any Trims)	
		Standard	Specialised	Standard	Specialised
 30mm	90cm	£13.57	£17.20	£12.21	£15.48
	180cm	£27.14	£34.40	£24.42	£30.96
	270cm	£40.71	£51.60	£36.63	£46.44
 38mm	90cm	£15.23	£22.95	£13.71	£20.66
	180cm	£30.46	£45.90	£27.42	£41.32
	270cm	£45.69	£68.85	£41.13	£61.98
 55mm	90cm	£20.28	£27.97	£18.25	£25.17
	180cm	£40.56	£55.94	£36.50	£50.34
	270cm	£60.84	£83.91	£54.75	£75.51

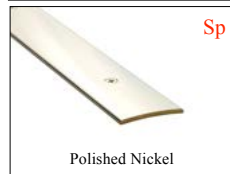
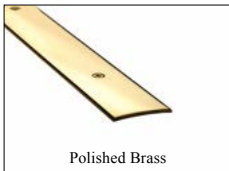

Carriage paid on 3 and over. Less than 3, add £7.50 for carriage, unless ordered with other items.



## **Product**

- The Premier Trim Cover range of door bars are manufactured using a base material of solid brass for a high quality installation.
- The Premier Trim Cover range are available in three lengths: 90cm, 180cm and 270cm.

## **Fitting**

- The Premier Trim Covers 30mm, 38mm and 55mm are a universal trim that can be used for a carpet to carpet, carpet to hard floor and between two hard floors.
- The Premier Trim Cover is a screw down trim with the screws remaining visible after fitting.
- When using on hard floor to hard floor with a height difference the Cover 30mm will accommodate up to a 4mm edge, the Cover 38mm up to a 6mm edge and the Cover 55mm up to a 8mm edge.
- Number 8 screws supplied.

ANY QUESTIONS  
Please call 01207 591176 For friendly expert advice.

## **See some installation examples below**

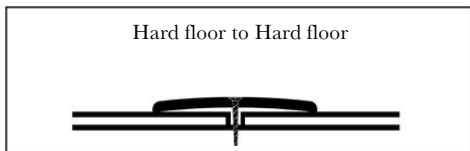
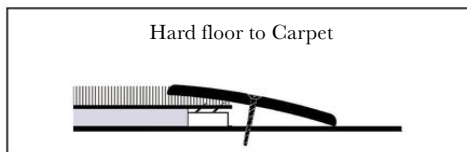
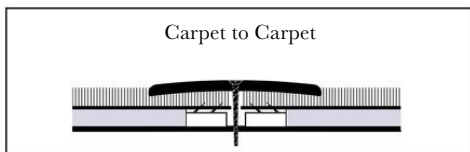

**Cleaning Guide, See page 112**

# Premier Euro Cover (non floating)



- Matches our DoubleZ™ top.
- For use with a level, non-floating, non-porous floor.
- Ideal for underfloor heating

## Euro Cover Prices (non floating)

Profile Type	Size	Individual Price		50 Price (Any Trims)	
		Standard	Specialised	Standard	Specialised
	90cm	£10.69	£15.02	£9.62	£13.52
	180cm	£21.38	£30.04	£19.24	£27.04
	270cm	£32.07	£45.06	£28.86	£40.55

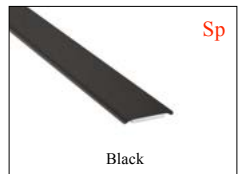
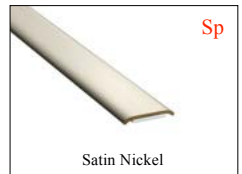
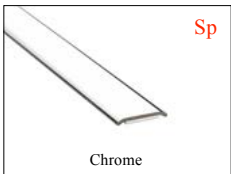
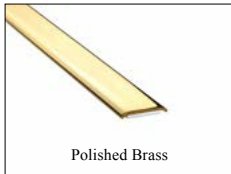

Carriage paid on 3 and over. Less than 3, add £7.50 for carriage, unless ordered with other items.



# Technical

## **Product**

- The Premier Euro Cover uses a base material of solid brass for a high-quality installation.
- Available lengths: 90cm, 180cm and 270cm.

## **Fitting**

- The Euro Cover is supplied with pre-attached adhesive tape suitable for non-porous surfaces.
- Degrease surface before installation.
- Transition for level surfaces.
- Suitable for non-floating hard floors such as LVT (stick down) and ceramics.

ANY QUESTIONS  
Please call 01207 591176 For friendly expert advice.

**Cleaning Guide, See page 112**

# Premier Floating Cover



- For use with a level, floating or non-floating non-porous floor.
- Ideal for underfloor heating
- Various widths to allow extra expansion.
- An attractive alternative to a 'T' moulding.

## Floating Cover Prices

Profile Size	Length	Individual Price		50 Price (Any Trims)	
		Standard	Specialised	Standard	Specialised
20mm	90cm -180cm - 270cm	£8.02 - £16.04 - £24.06	£11.52 - £23.04 - £34.56	£7.22 - £14.44 - £21.66	£10.37 - £20.74 - £31.11
30mm	90cm -180cm - 270cm	£9.17 - £18.34 - £27.51	£12.64 - £25.28 - £37.92	£8.25 - £16.50 - £24.75	£11.38 - £22.76 - £34.14
40mm	90cm -180cm - 270cm	£12.08 - £24.16 - £36.24	£15.54 - £31.08 - £46.62	£10.87 - £21.74 - £32.61	£13.99 - £27.98 - £41.97
50mm	90cm -180cm - 270cm	£13.86 - £27.72 - £41.58	£17.33 - £34.66 - £51.99	£12.47 - £24.94 - £37.41	£15.60 - £31.20 - £46.80

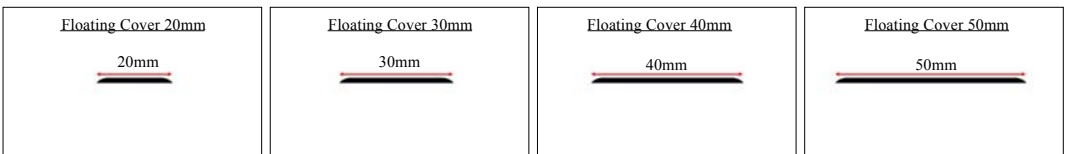

Carriage paid on 5 and over. Less than 5, add £7.50 for carriage, unless ordered with other items.



## **Product**

- Premier Floating Cover uses a base material of solid brass for a high-quality installation.
- Available lengths: 90cm, 180cm and 270cm.

## **Fitting**

- The Floating Cover is supplied with pre-attached adhesive tape suitable for non-porous surfaces.
- Degrease surface before installation.
- Suitable for timber, laminates and floating LVT, WPC/SPC products requiring expansion and non-floating floors.
- The trim is supplied with 2 rows of tape: use both tapes on a non-floating hard floor and only one on a floating hard floor.
- View our Stairrods YouTube channel for installation video.
- Consult the flooring manufacturer regarding expansion requirements.

ANY QUESTIONS  
Please call 01207 591176 For friendly expert advice.

## **See some installation examples below**

20mm allows maximum of 10mm expansion



30mm allows maximum of 20mm expansion



40mm allows maximum of 30mm expansion



50mm allows maximum of 40mm expansion

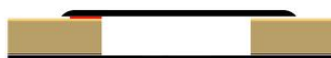



**Cleaning Guide, See page 112**

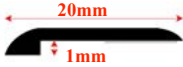

- For use with a level, floating or non-floating non-porous floor.
- Ideal for underfloor heating.
- 1mm or 2mm drop.
- An attractive alternative to a "T" moulding.

## Floating Vinyl Edge Prices

Profile Type	Size	Individual Price		50 Price (Any Trims)	
		Standard	Specialised	Standard	Specialised
<b>Floating Vinyl Edge 1mm</b> 	90cm	£8.58	£12.08	£7.72	£10.87
	180cm	£17.16	£24.16	£15.44	£21.74
	270cm	£25.74	£36.24	£23.16	£32.61
<b>Floating Vinyl Edge 2mm</b> 	90cm	£9.10	£12.60	£8.19	£11.34
	180cm	£18.20	£25.20	£16.38	£22.68
	270cm	£27.30	£37.80	£24.57	£34.02

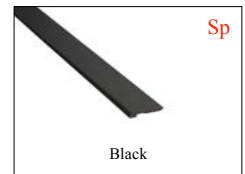
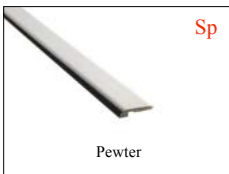
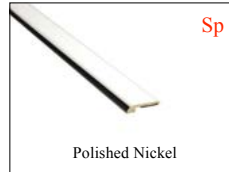
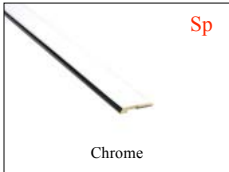
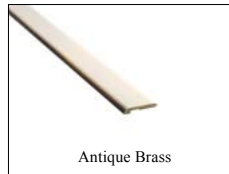
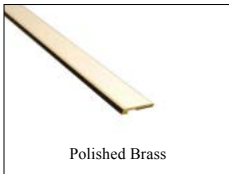

Carriage paid on 5 and over. Less than 5, add £7.50 for carriage, unless ordered with other items.



# Technical



60

## **Product**

- The Premier Vinyl Edge uses a base material of solid brass for a high-quality installation.
- Available lengths: 90cm, 180cm and 270cm.

## **Fitting**

- The Vinyl Edge is supplied with pre-attached adhesive tape suitable for non-porous surfaces.
- Degrease surface before installation.
- Suitable for timber, laminates and floating LVT, WPC/SPC requiring expansion and non-floating hard floors.
- Consult the flooring manufacturer regarding expansion requirements.

ANY QUESTIONS  
Please call 01207 591176 For friendly expert advice.

Get your Drop Checker



Ask your Stairrods UK Sales Representative.

## **See some installation examples below**

1mm Floating Vinyl Edge



2mm Floating Vinyl Edge



**Cleaning Guide, See page 112**

# Premier TwoWay Ramp 2-3mm, 4-5mm, 6-7mm & 8-9mm

61



- For use with floating or non-floating non-porous floors.
- Ideal for underfloor heating.
- Covers height differences between 2-9mm.
- An attractive alternative to a timber/plastic Reducer.

## Two-Way Ramp Prices

Profile Size	Length	Individual Price			50 Price (Any Trims)	
		Standard	Specialised		Standard	Specialised
2-3mm	90cm / 180cm / 270cm	£9.49 / £18.98 / £28.47	£12.99 / £25.98 / £38.97		£8.51 / £17.02 / £25.53	£11.69 / £23.38 / £35.07
4-5mm	90cm / 180cm / 270cm	£10.12 / £20.24 / £30.36	£13.62 / £27.24 / £40.86		£9.11 / £18.22 / £27.33	£12.26 / £24.52 / £36.78
6-7mm	90cm / 180cm / 270cm	£11.03 / £22.06 / £33.09	£14.53 / £29.06 / £43.59		£9.93 / £19.86 / £29.79	£13.08 / £26.16 / £39.24
8-9mm	90cm / 180cm / 270cm	£12.22 / £24.44 / £36.66	£15.72 / £31.44 / £47.16		£11.00 / £22.00 / £33.00	£14.15 / £28.30 / £42.45

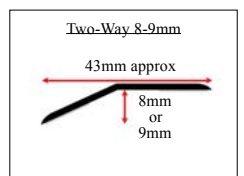
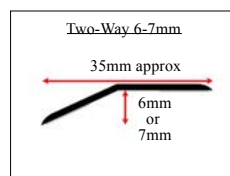
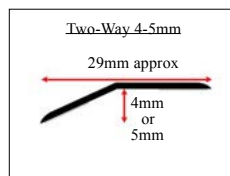
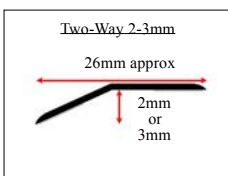

Carriage paid on 5 and over. Less than 5, add £7.50 for carriage, unless ordered with other items.



## **Product**

- The Premier Two Way Ramp uses a base material of solid brass for a high-quality installation.
- Available lengths: 90cm, 180cm and 270cm.

## **Fitting**

- The Two Way Ramp is supplied with pre-attached adhesive tape suitable for non-porous surfaces.
- Degrease surface before installation.
- Suitable for timber, laminates and floating LVT, WPC/SPC requiring expansion and non-floating hard floors.
- Consult the flooring manufacturer regarding expansion requirements.

ANY QUESTIONS  
Please call 01207 591176 For friendly expert advice.

Get your Drop Checker



Ask your Stairrods UK Sales Representative.

**See some installation examples below**

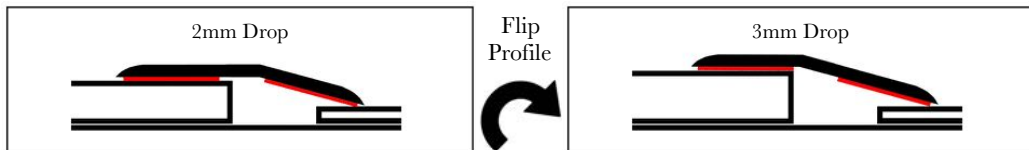

**Cleaning Guide, See page 112**



- For use with floating or non-floating non-porous floors.
- Ideal for underfloor heating.
- Covers height differences of 10mm, 12mm, 14mm, 16mm and 20mm.
- An attractive alternative to a timber/plastic Reducer.

## Ramp Prices

Profile Size	Length	Individual Price		50 Price (Any Trims)	
		Standard	Specialised	Standard	Specialised
10mm	90cm / 180cm / 270cm	£10.40 / £20.80 / £31.20	£13.90 / £27.80 / £41.70	£9.36 / £18.72 / £28.08	£12.51 / £25.02 / £37.53
12mm	90cm / 180cm / 270cm	£11.06 / £22.12 / £33.18	£14.56 / £29.12 / £43.68	£9.95 / £19.90 / £29.85	£13.10 / £26.20 / £39.30
14mm	90cm / 180cm / 270cm	£12.60 / £25.20 / £37.80	£17.01 / £34.02 / £51.03	£11.34 / £22.68 / £34.02	£15.31 / £30.62 / £45.93
16mm	90cm / 180cm / 270cm	£13.27 / £26.54 / £39.81	£17.71 / £35.42 / £53.13	£11.94 / £23.88 / £35.82	£15.94 / £31.88 / £47.82
20mm	90cm / 180cm / 270cm	£14.46 / £28.92 / £43.38	£19.00 / £38.00 / £57.00	£13.01 / £26.02 / £39.03	£17.10 / £34.20 / £51.30

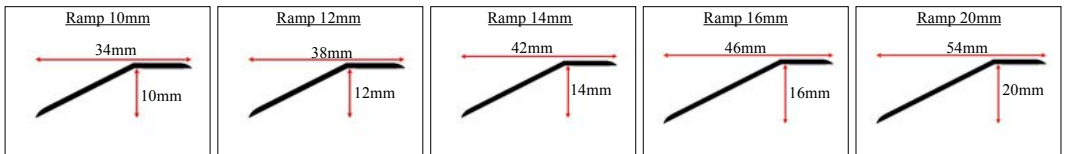

Carriage paid on 5 and over. Less than 5, add £7.50 for carriage, unless ordered with other items.



# Technical



64

## **Product**

- The Premier Ramp range of door bars are manufactured using a base material of solid brass for a high quality installation.
- The Premier Ramp range are available in three lengths: 90cm, 180cm and 270cm.

## **Fitting**

- The Ramps are supplied with pre-attached adhesive tape suitable for non-porous surfaces.
- Degrease surface before installation.
- Suitable for timber, laminates and floating LVT, WPC/SPC requiring expansion and non-floating hard floors.
- Consult the flooring manufacturer regarding expansion requirements.

ANY QUESTIONS  
Please call 01207 591176 For friendly expert advice.

Get your Drop Checker



Ask your Stairrods UK Sales Representative.

**See an installation example below**

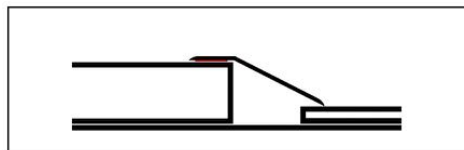

**Cleaning Guide, See page 112**

# Premier Carpet Ramp



- A useful ramp for carpet to hard floor with a 5mm height difference.
- The maximum height our 15mm Easyshims will achieve is 25mm on a stretch fit installation
- The Carpet Ramp will increase this option by 5mm.
- Ideal for underfloor heating.

## Carpet Ramp Prices

		Individual Price		50 Price (Any Trims)	
Profile Type	Size	Standard	Specialised	Standard	Specialised
<b>Carpet Ramp 5mm</b> 	<b>90cm</b>	£11.90	£15.40	£10.71	£13.86
	<b>180cm</b>	£23.80	£30.80	£21.42	£27.72
	<b>270cm</b>	£35.70	£46.20	£32.13	£41.58

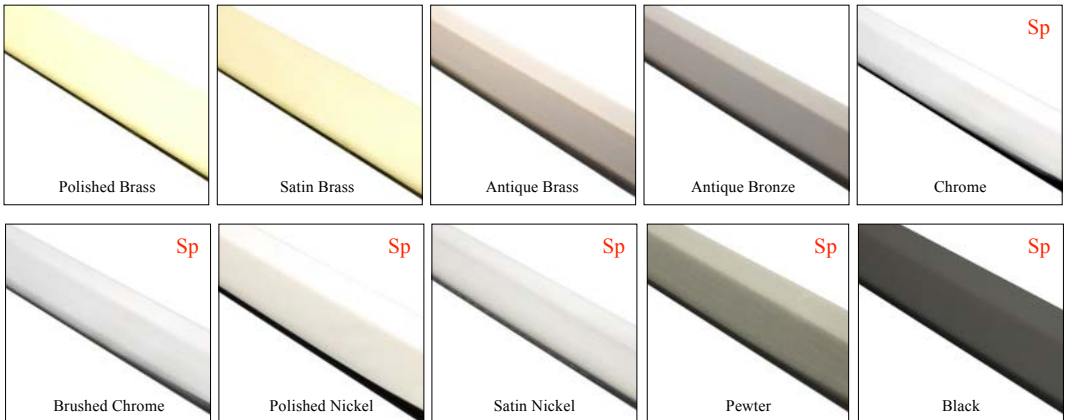

Carriage paid on 3 and over. Less than 3, add £7.50 for carriage, unless ordered with other items.



## **Product**

- The Premier Carpet Ramp uses a base material of solid brass for a high-quality installation.
- Available lengths: 90cm, 180cm and 270cm.

## **Fitting**

- The Carpet Ramps are supplied with pre-attached adhesive tape suitable for non-porous surfaces.
- Degrease surface before installation.
- Suitable for carpet to timber, laminates and floating LVT requiring expansion and non-floating hard floors.
- Consult the flooring manufacturer regarding expansion requirements.

ANY QUESTIONS  
Please call 01207 591176 For friendly expert advice.

Get your Drop Checker



Ask your Stairrods UK Sales Representative.

## **See some installation examples below**

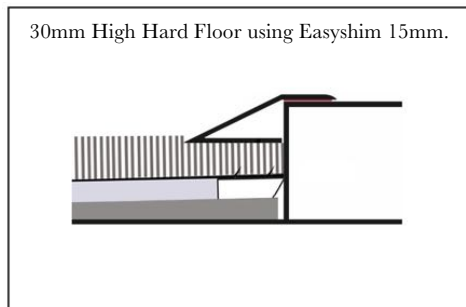
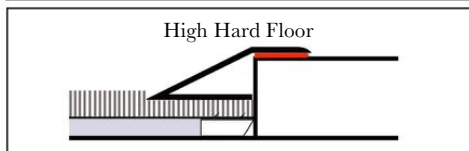
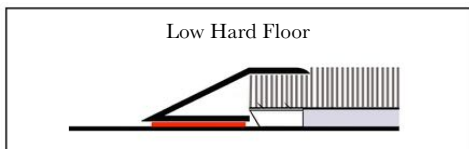

**Cleaning Guide, See page 112**

# Premier Dividers 6mm Wide



\* For use with non-floating hard floors and carpets fitted straight or curved.

## Divider Prices

Profile	Size	Individual Price		50 Price (Any Trims)	
		Standard	Specialised	Standard	Specialised
D3.5	90cm / 180cm / 270cm	£8.97 / £17.94 / £26.91	£11.76 / £23.52 / £35.28	£8.07 / £16.14 / £24.21	£10.58 / £21.16 / £31.74
D4.5	90cm / 180cm / 270cm	£9.39 / £18.87 / £28.17	£12.18 / £24.36 / £36.54	£8.45 / £16.90 / £25.35	£10.96 / £21.92 / £32.88
D6.	90cm / 180cm / 270cm	£10.11 / £20.22 / £30.33	£12.90 / £25.80 / £38.70	£9.10 / £18.20 / £27.30	£11.61 / £23.22 / £34.83
D7.5	90cm / 180cm / 270cm	£9.48 / £18.96 / £28.44	£12.27 / £24.54 / £36.81	£8.53 / £17.06 / £25.59	£11.04 / £22.08 / £33.12
D9.5	90cm / 180cm / 270cm	£9.72 / £19.44 / £29.26	£12.51 / £25.02 / £37.53	£8.75 / £17.50 / £26.25	£11.26 / £22.52 / £33.78
D12	90cm / 180cm / 270cm	£10.02 / £20.04 / £30.06	£12.81 / £25.62 / £38.43	£9.00 / £18.00 / £27.00	£11.53 / £23.06 / £34.59
D14	90cm / 180cm / 270cm	£10.29 / £20.58 / £30.87	£13.08 / £26.16 / £39.24	£9.26 / £18.52 / £27.78	£11.77 / £23.54 / £35.31
D16	90cm / 180cm / 270cm	£10.53 / £21.06 / £31.59	£13.32 / £26.64 / £39.96	£9.48 / £18.96 / £28.44	£11.99 / £23.98 / £35.96
D19	90cm / 180cm / 270cm	£10.92 / £21.84 / £32.76	£13.71 / £27.42 / £41.13	£9.83 / £19.66 / £29.49	£12.34 / £24.68 / £37.02
D23	90cm / 180cm / 270cm	£11.49 / £22.98 / £34.47	£14.28 / £28.56 / £42.84	£10.34 / £20.68 / £31.02	£12.85 / £25.70 / £38.55
D25	90cm / 180cm / 270cm	£14.70 / £29.40 / £44.10	£17.49 / £34.98 / £52.47	£13.23 / £26.46 / £39.69	£15.74 / £31.48 / £47.22

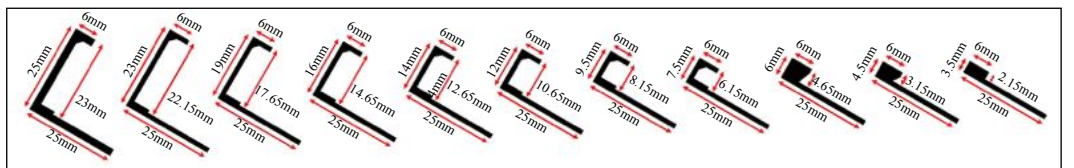
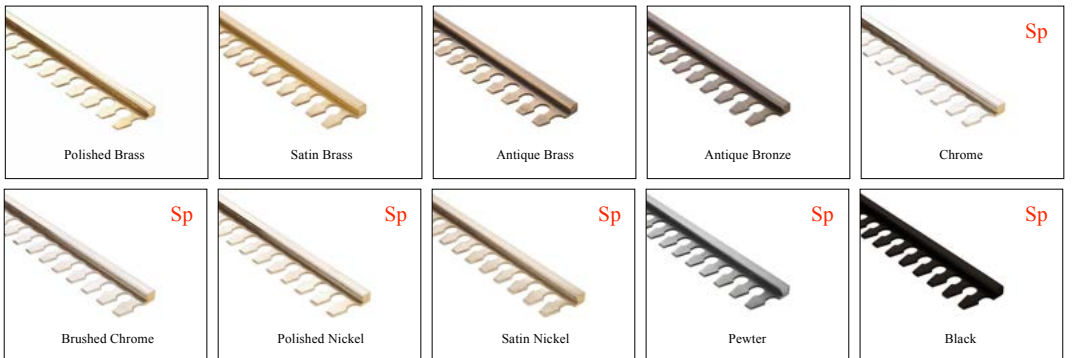

Carriage paid on 5 and over. Less than 5, add £7.50 for carriage, unless ordered with other items.



## **Product**

- The Premier Dividers uses a base material of solid brass for a high-quality installation.
- Available lengths: 90cm, 180cm and 270cm.

## **Fitting**

- The Dividers are for use with non-floating floors to offer a fine edge trim which can be curved.
- Suitable for glue down and stretch fit carpet to LVT Dryback (stick down) and non-floating hard floors.
- Unsuitable for any wood flooring as this requires expansion and a trim would prevent this. Including glue down.
- Requires a detailed sub floor prep to match heights.
- Pre-drilled and counter sunk at 8cm centres.

ANY QUESTIONS  
Please call 01207 591176 For friendly expert advice.

## **See some installation examples below**

LVT to LVT



Stick down Carpet to LVT



Stick down Carpet to Stick down Carpet



Hard Floor to Carpet



**Cleaning Guide, See page 112**

New

# Premier Inlay

69



- An alternative to LVT inlays giving a defined shine.
- Premier Inlays are made from solid brass and then plated in Nickel and Chrome.

## Inlay Prices

Profile Type	Individual Price	50 Price (Any Trims)
Inlay 100cm Lengths	£8.90 Each	£8.01 Each

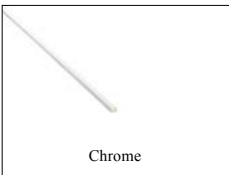

Chrome

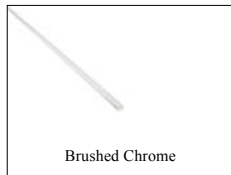

Brushed Chrome



Polished Nickel



Satin Nickel

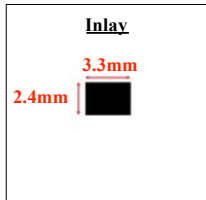

Carriage paid on 5 and over. Less than 5, add £7.50 for carriage, unless ordered with other items.



# Technical

## **Product**

- The Premier Inlays use a base material of solid brass for a high-quality installation.
- Available length: 100cm.

## **Fitting**

- The Premier Inlays are 3.3mm wide 2.4mm in depth.
- Suitable for 2.5mm and 3mm LVT dryback adhered directly to the floor.
- See our fitting video on Stairrods YouTube channel.
- Difficult to curve.
- Use F49 adhesive.
- Use a Dremel with metal cutter blade or cutting disk to avoid chipping the chrome finish.

ANY QUESTIONS  
Please call 01207 591176 For friendly expert advice.

**Cleaning Guide, See page 112**

# Premier LVT Square Cap

71



- A discreet trim for LVT.
- For use with LVT Dryback (glue down) and Floating LVT with max expansion of 4-5mm.
- An attractive alternative to a Quarter Round and a Transition Moulding.

## LVT Square Cap Prices

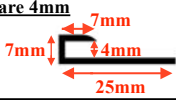
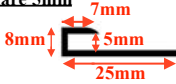
Profile Type	Size	Individual Price		50 Price (Any Trims)	
		Standard	Specialised	Standard	Specialised
<b>LVT Square 4mm</b> 	90cm	£10.92	£14.91	£9.83	£13.42
	180cm	£21.84	£29.82	£19.66	£26.84
	270cm	£32.76	£44.73	£29.49	£40.26
<b>LVT Square 5mm</b> 	90cm	£10.92	£14.91	£9.83	£13.42
	180cm	£21.84	£29.82	£19.66	£26.84
	270cm	£32.76	£44.73	£29.49	£40.26

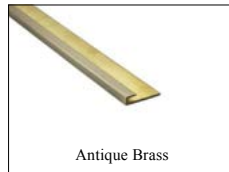

Carriage paid on 5 and over. Less than 5, add £7.50 for carriage, unless ordered with other items.



## **Product**

- The Premier LVT Square Cap uses a base material of solid brass for a high-quality installation.
- Available lengths: 90cm, 180cm and 270cm.

## **Fitting**

- The Square Cap is pre-drilled and countersunk.
- Suitable for matwell surrounds, stop ends/junctions with windows and doors.
- Consult the flooring manufacturer regarding expansion requirements.

ANY QUESTIONS  
Please call 01207 591176 For friendly expert advice.

## **See some installation examples below**

Stick Down Carpet to LVT



Patio Door Edge to LVT

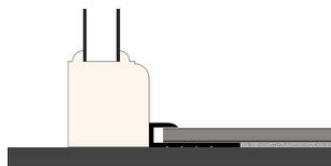

**Cleaning Guide, See page 112**

# Premier LVT Bevel Cap



- A discreet trim for LVT.
- For use with LVT Dryback (glue down) and Floating LVT with max expansion of 4-5mm.

## LVT Bevel Cap Prices

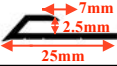
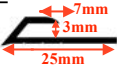
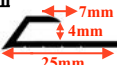
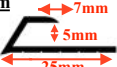
Profile Type	Size	Individual Price		50 Price (Any Trims)	
		Standard	Specialised	Standard	Specialised
<b>LVT Bevel 2.5mm</b> 	90cm	£10.92	£14.91	£9.83	£13.42
	180cm	£21.84	£29.82	£19.66	£26.84
	270cm	£32.76	£44.73	£29.49	£40.26
<b>LVT Bevel 3mm</b> 	90cm	£10.92	£14.91	£9.83	£13.42
	180cm	£21.84	£29.82	£19.66	£26.84
	270cm	£32.76	£44.73	£29.49	£40.26
<b>LVT Bevel 4mm</b> 	90cm	£10.92	£14.91	£9.83	£13.42
	180cm	£21.84	£29.82	£19.66	£26.84
	270cm	£32.76	£44.73	£29.49	£40.26
<b>LVT Bevel 5mm</b> 	90cm	£10.92	£14.91	£9.83	£13.42
	180cm	£21.84	£29.82	£19.66	£26.84
	270cm	£32.76	£44.73	£29.49	£40.26

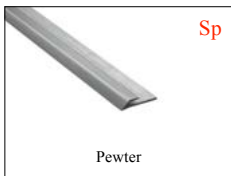

Carriage paid on 5 and over. Less than 5, add £7.50 for carriage, unless ordered with other items.



## **Product**

- The Premier LVT Bevel Cap uses a base material of solid brass for a high-quality installation.
- Available lengths: 90cm, 180cm and 270cm.

## **Fitting**

- The Bevel Cap is pre-drilled and countersunk.
- Suitable for stop ends/junctions with windows and doors.
- Consult the flooring manufacturer regarding expansion requirements.

ANY QUESTIONS  
Please call 01207 591176 For friendly expert advice.

## **See some installation examples below**

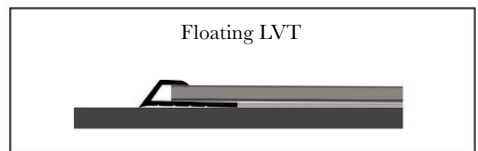
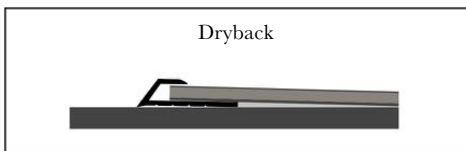

**Cleaning Guide, See page 112**

# Premier LVT Nosing (no bull)

75



- LVT on a right angled step.
- For use with LVT Dryback (glue down), Floating LVT, WPC/SPC with max expansion of 4-5mm and some thin glue down carpets.
- Pre-drilled middle and back edge.
- Includes 2mm full length MDF spacer.

## LVT Nosing (no bull) prices

Profile Type	Size	Individual Price		50 Price (Any Trims)	
		Standard	Specialised	Standard	Specialised
2.5mm	90cm	£20.03	£24.14	£18.03	£21.73
	180cm	£40.06	£48.28	£36.06	£43.46
	270cm	£60.09	£72.42	£54.09	£65.19
3mm	90cm	£20.03	£24.14	£18.03	£21.73
	180cm	£40.06	£48.28	£36.06	£43.46
	270cm	£60.09	£72.42	£54.09	£65.19
4mm	90cm	£20.03	£24.14	£18.03	£21.73
	180cm	£40.06	£48.28	£36.06	£43.46
	270cm	£60.09	£72.42	£54.09	£65.19
5mm	90cm	£20.03	£24.14	£18.03	£21.73
	180cm	£40.06	£48.28	£36.06	£43.46
	270cm	£60.09	£72.42	£54.09	£65.19

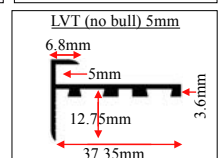
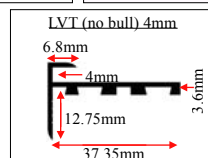
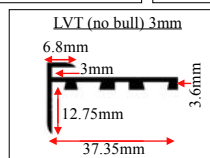
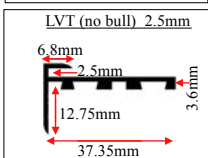

Carriage paid on 3 and over. Less than 3, add £7.50 for carriage, unless ordered with other items.



## **Product**

- The Premier LVT Nosing (no bull) uses a base material of solid brass for a high-quality installation.
- Available lengths: 90cm, 180cm and 270cm.

## **Fitting**

- The no bull is pre-drilled and countersunk on the middle and back edge.
- Includes a 2mm MDF full length spacer to raise the base for 6mm plywood.
- Allows expansion for Floating LVT on the top step to landings.
- Suitable for LVT 2.5mm, 3mm, 4mm and 5mm.
- Consult the flooring manufacturer regarding expansion requirements on Floating LVT.

ANY QUESTIONS  
Please call 01207 591176 For friendly expert advice.

**See some installation examples below**

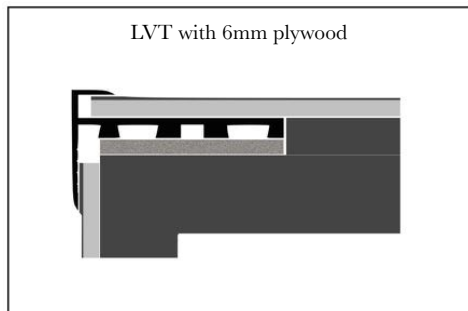
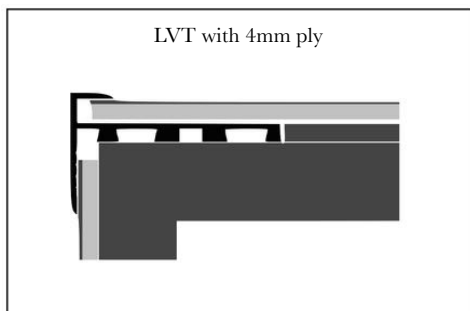

**Cleaning Guide, See page 112**

# Premier LVT Nosing (full bull)



- LVT on a bullnose step.
- For use with LVT Dryback (glue down), Floating LVT, WPC/SPC with max expansion of 4-5mm and some thin glue down carpets.
- Pre-drilled middle and back edge.
- Includes 2mm full length MDF spacer.

## LVT Nosing (full bull) Prices

Profile Type	Size	Individual Price		50 Price (Any Trims)	
		Standard	Specialised	Standard	Specialised
2.5mm	90cm	£23.52	£28.56	£21.17	£25.70
	180cm	£47.04	£57.12	£42.34	£51.40
	270cm	£70.56	£85.68	£63.51	£77.10
3mm	90cm	£23.52	£28.56	£21.17	£25.70
	180cm	£47.04	£57.12	£42.34	£51.40
	270cm	£70.56	£85.68	£63.51	£77.10
4mm	90cm	£23.52	£28.56	£21.17	£25.70
	180cm	£47.04	£57.12	£42.34	£51.40
	270cm	£70.56	£85.68	£63.51	£77.10
5mm	90cm	£23.52	£28.56	£21.17	£25.70
	180cm	£47.04	£57.12	£42.34	£51.40
	270cm	£70.56	£85.68	£63.51	£77.10

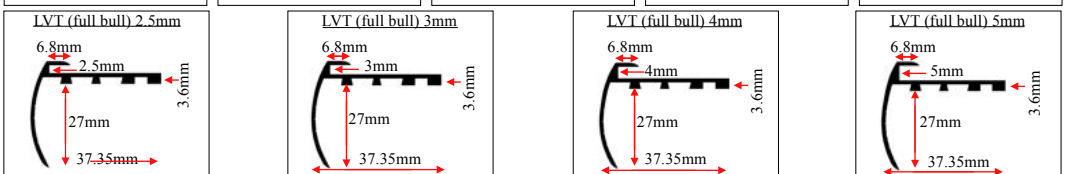

**Carriage paid on 3 and over. Less than 3, add £7.50 for carriage, unless ordered with other items.**



## **Product**

- The Premier LVT Nosing (full bull) uses a base material of solid brass for a high-quality installation.
- Available lengths: 90cm, 180cm and 270cm.

## **Fitting**

- The full bull is pre-drilled and countersunk on the middle and back edge.
- Includes a 2mm MDF full length spacer to raise the base for 6mm plywood.
- Allows expansion for Floating LVT on the top step to landings.
- Suitable for LVT 2.5mm, 3mm, 4mm and 5mm.
- Consult the flooring manufacturer regarding expansion requirements on Floating LVT.

ANY QUESTIONS  
Please call 01207 591176 For friendly expert advice.

## **See some installation examples below**

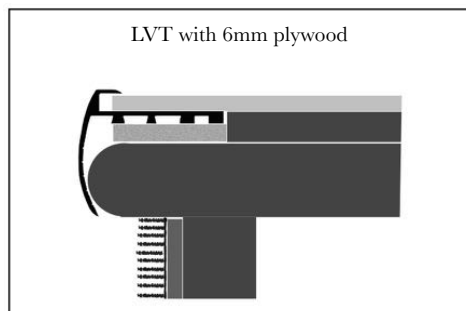
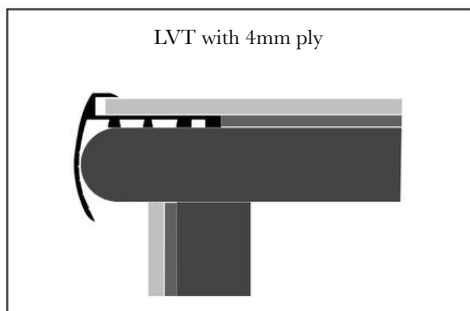

**Cleaning Guide, See page 112**

# Premier Bendybull

79



Bendybull is an attractive stair nosing for curved/curtail treads and straight steps between 22mm-25mm thickness. For use with LVT, Floating LVT, WPC/SPC (any multi-layered flooring), Safety Flooring and some glue down carpets at 5-6mm.

## Premier Bendybull

Profile Type	Size	Individual Price		50 Price (Any Trims)	
		Standard	Specialised	Standard	Specialised
2.5mm	90cm	£19.06	£23.93	£17.15	£21.54
	180cm	£38.12	£47.86	£34.30	£43.08
	270cm	£57.18	£71.79	£51.45	£64.62
3mm	90cm	£19.06	£23.93	£17.15	£21.54
	180cm	£38.12	£47.86	£34.30	£43.08
	270cm	£57.18	£71.79	£51.45	£64.62
4mm	90cm	£19.06	£23.93	£17.15	£21.54
	180cm	£38.12	£47.86	£34.30	£43.08
	270cm	£57.18	£71.79	£51.45	£64.62
5mm	90cm	£19.06	£23.93	£17.15	£21.54
	180cm	£38.12	£47.86	£34.30	£43.08
	270cm	£57.18	£71.79	£51.45	£64.62

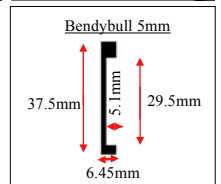
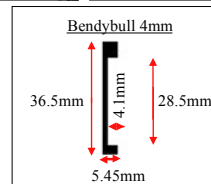
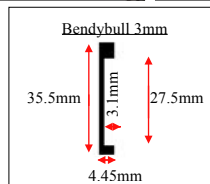
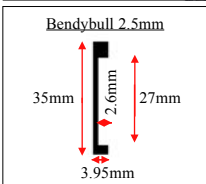

Carriage paid on 3 and over. Less than 3, add £7.50 for carriage, unless ordered with other items.



## Product

- The Premier Bendybull uses a base material of solid brass for a high-quality installation.
- Available lengths: 90cm, 180cm and 270cm.

## Fitting

- Premier Bendybull is available in 4 recess options: 2.5mm, 3mm, 4mm and 5mm.
- Bendybull 2.5mm and 3mm (recess) for use with LVT/plywood prep. Bendybull 4mm and 5mm (recess) for use with Floating LVT/plywood prep.
- See our fitting video on Stairrods YouTube channel for Bendybull full install, Bendybull light commercial and Bendybull with WPC/SPC.
- Pre-drilled/countersunk at 75mm centres and supplied with Spax-M self-drilling screws (do not pre-drill). Requires a T20 star bit.
- Use a dim strip or strip of vinyl for an exact measure.
- We advise the use of a non expanding cartridge adhesive such as F-Ball & Co's Stycco Flex as a secondary fixing.
- Template the plywood after the Bendybull is fitted.
- We do not have an overlap option for the top step to allow expansion on Floating LVT and WPC/SPC products. We suggest using our Full Bull or our new Ali Wrap Nosing overlap option.
- For WPC/SPC between 6.5mm and 8mm omit the plywood and use the 2.5mm recess.
- Consider 4mm ply with thinner SPC. For steep steps consider 4mm ply rather than 6mm to drop the height of the nosing.
- Bendybull will not mitre/return as it produces a sharp corner. Consider our new Ali Wrap Nosings.

## See some installation examples

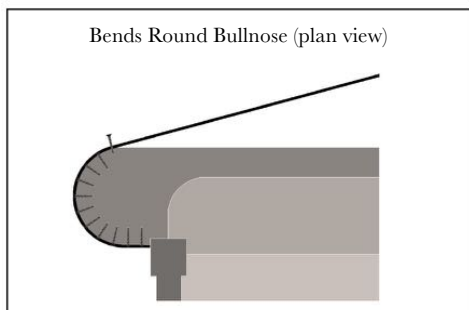
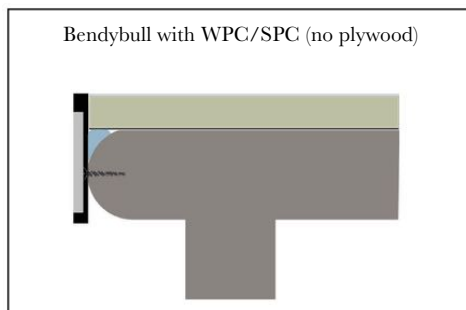
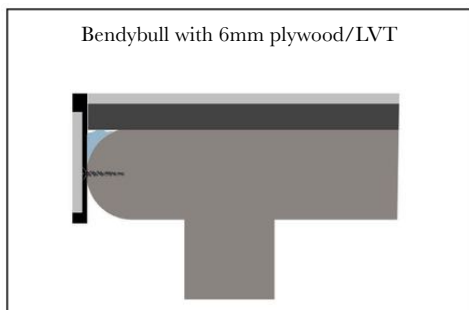

**Cleaning Guide, See page 112**

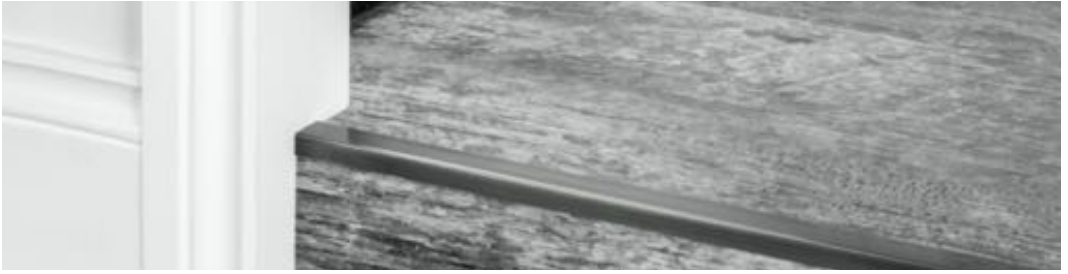

• Various sizes and uses for adhering to non-porous floors.

## Lip Prices

Profile Size	Length	Individual Price		50 Price (Any Trims)	
		Standard	Specialised	Standard	Specialised
Lip	90cm / 180cm / 270cm	£8.34 / £16.68 / £25.02	£12.43 / £24.55 / £35.20	£7.51 / £15.02 / £22.53	£11.19 / £22.39 / £33.58
Little Lip	90cm / 180cm / 270cm	£7.70 / £15.40 / £23.10	£11.20 / £22.40 / £33.60	£6.93 / £13.86 / £20.79	£10.08 / £20.16 / £30.24
Bigger Lip	90cm / 180cm / 270cm	£10.92 / £21.84 / £32.76	£14.84 / £29.68 / £44.52	£9.83 / £19.66 / £29.49	£13.36 / £26.72 / £40.08
Wide Lip	90cm / 180cm / 270cm	£12.78 / £25.56 / £38.34	£16.70 / £33.40 / £50.10	£11.50 / £23.00 / £34.50	£15.03 / £30.06 / £45.09
Square Lip	90cm / 180cm / 270cm	£12.78 / £25.56 / £38.34	£16.70 / £33.40 / £50.10	£11.50 / £23.00 / £34.50	£15.03 / £30.06 / £45.09

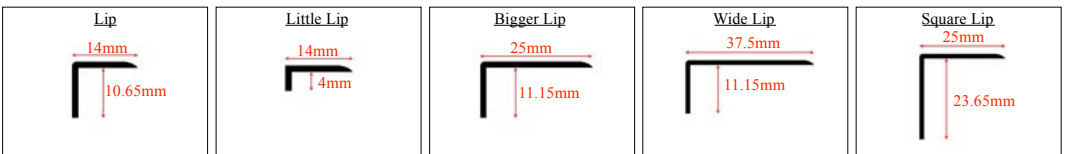

Carriage paid on 5 and over. Less than 5, add £7.50 for carriage, unless ordered with other items.



# Technical

## **Product**

- The Premier Lips use a base material of solid brass for a high-quality installation.
- Available lengths: 90cm, 180cm and 270cm.

## **Fitting**

- The Lips are supplied with pre-attached adhesive tape suitable for non-porous surfaces.
- Degrease surface before installation.
- Various tape options.
- The Lips will be supplied with tape option 1 unless specified.
- Suitable for matwell surrounds, stop ends/junctions with windows/doors, plinths etc.

ANY QUESTIONS  
Please call 01207 591176 For friendly expert advice.

## **See some installation examples below**

Tape Option 1

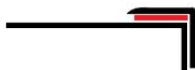

Tape Option 2

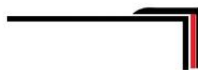

Tape Option 3

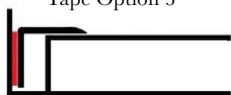

**Cleaning Guide, See page 112**



- The Premier Ts allow for slight imperfections in joints and enables a gap between floor finishes to be incorporated during installation. Allowing natural expansion in flooring materials such as ceramics and wood.
- Premier Ts are fitted after the floorcoverings have been installed, making them ideal for use when the installation of the floorcoverings is undertaken by different trades (e.g. ceramic contractors and flooring contractors) where the trims cannot be fixed until both floors have been completed.

## T Prices

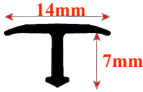
Profile Type	Size	Individual Price		50 Price (Any Trims)	
		Standard	Specialised	Standard	Specialised
<b>Little T</b> 	90cm	£7.84	£11.34	£7.06	£10.21
	180cm	£15.68	£22.68	£14.12	£20.42
	270cm	£23.52	£34.02	£21.18	£30.63
<b>Big T</b> 	90cm	£10.64	£14.14	£9.58	£12.73
	180cm	£21.28	£28.28	£19.16	£25.46
	270cm	£31.92	£42.42	£28.74	£38.19

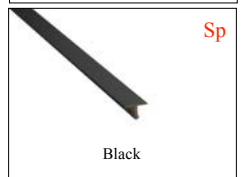
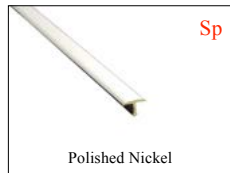
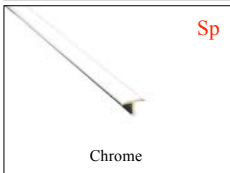
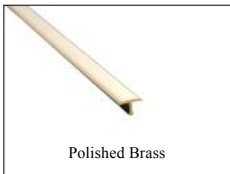

Carriage paid on 5 and over. Less than 5, add £7.50 for carriage, unless ordered with other items.



## **The Product**

- The Premier Ts use a base material of solid brass for a high-quality installation.
- Available lengths: 90cm, 180cm and 270cm.

## **Fitting**

- The Ts are fitted with a silicone adhesive.
- Suitable for ceramics and stone transitions of similar height.

ANY QUESTIONS  
Please call 01207 591176 For friendly expert advice.

**See an installation example below**

Use silicone adhesive to secure Premier Ts



**Cleaning Guide, See page 112**



- Little nosing for a right angled or rake backed step.
- Ideal for LVT dryback (glue down) and ceramics.

## Little Nose Prices

Profile Type	Size	Individual Price		50 Price (Any Trims)	
		Standard	Specialised	Standard	Specialised
	90cm	£10.36	£13.86	£9.32	£12.47
	180cm	£20.72	£27.72	£18.64	£24.94
	270cm	£31.08	£41.58	£27.96	£37.41

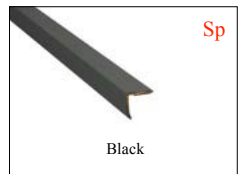
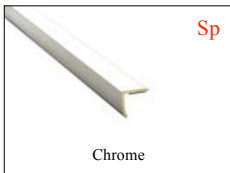
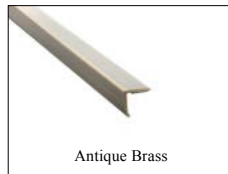
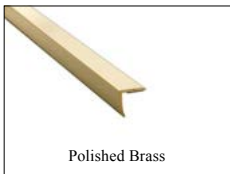

Carriage paid on 5 and over. Less than 5, add £7.50 for carriage, unless ordered with other items.



## **Product**

- The Premier Little Nose uses a base material of solid brass for a high-quality installation.
- Available lengths: 90cm, 180cm and 270cm.

## **Fitting**

- The Little Nose is supplied with pre-attached adhesive tape suitable for non-porous surfaces.
- Degrease surface before installation.
- Prior to removing the backing tape, lay the nosing in position and mark the position of the back edge with pieces of masking tape, this will be your guide for positioning the nosing during fitting. This needs to be done as it gives the exact final position of the nosing allowing for variations in the rake of the risers.

ANY QUESTIONS  
Please call 01207 591176 For friendly expert advice.

## **See some installation examples below**

Mark Position



Add Stycco Flex



Apply Little Nose



Finished



**Cleaning Guide, See page 112**

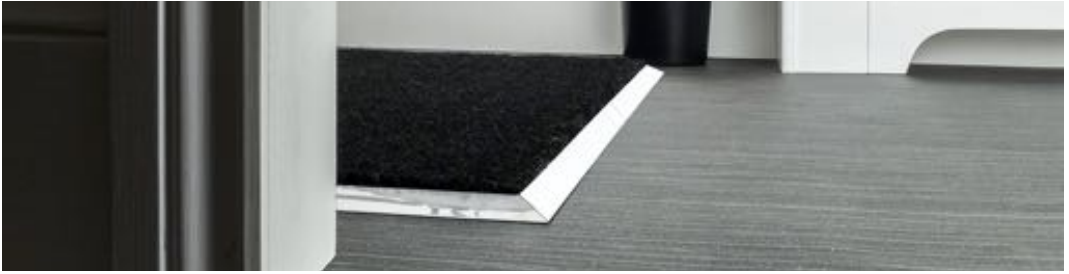

- An attractive matwell surround for 17mm and 12mm ribbed matting.
- For use with a level non-floating non-porous floor.
- Ideal for underfloor heating

## Matwell (non floating) Prices

Profile Type	Size	Individual Price		50 Price (Any Trims)	
		Standard	Specialised	Standard	Specialised
<b>Matwell (non floating) 5mm</b> 	90cm	£10.89	£15.02	£9.80	£13.52
	180cm	£21.78	£30.04	£19.60	£27.04
	270cm	£32.67	£45.06	£29.40	£40.56
<b>Matwell (non floating) 8mm</b> 	90cm	£13.40	£17.54	£12.06	£15.79
	180cm	£26.80	£35.08	£24.12	£31.58
	270cm	£40.20	£52.62	£36.18	£47.37



Carriage paid on 5 and over. Less than 5, add £7.50 for carriage, unless ordered with other items.



## **Product**

- The Premier Matwells (non floating) uses a base material of solid brass for a high-quality installation.
- Available lengths: 90cm, 180cm and 270cm.

## **Fitting**

- The Matwells (non floating) with pre-attached adhesive tape suitable for non-porous surfaces.
- Degrease surface before installation.
- Suitable for LVT Dryback (glue down) on non-floating floors using either the smoothing compound and or plywood and LVT to create a void.
- For existing non-floating floors consider our Single 9 or Single 13 for either 12mm or 17mm matting.

ANY QUESTIONS  
Please call 01207 591176 For friendly expert advice.

## **See some installation examples below**

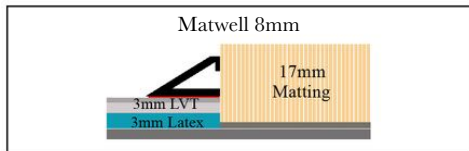
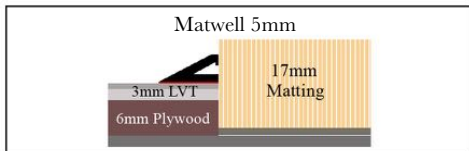
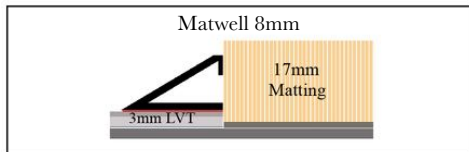
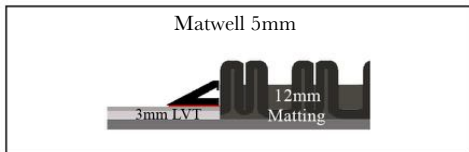

**Cleaning Guide, See page 112**



- An attractive matwell surround for 17mm and 12mm ribbed matting.
- For use with floating floors requiring expansion.
- Three expansion options and two matting depths.

## Floating Matwell Prices

Profile	Size	Individual Price		50 Price (Any Trims)	
		Standard	Specialised	Standard	Specialised
12mm Small	90cm / 180cm / 270cm	£14.70 / £29.40 / £44.10	£19.81 / £39.62 / £59.43	£13.23 / £26.46 / £39.69	£17.83 / £35.66 / £53.49
12mm Medium	90cm / 180cm / 270cm	£15.82 / £31.64 / £47.46	£21.04 / £42.08 / £63.12	£14.24 / £28.48 / £42.72	£18.94 / £37.88 / £56.82
12mm Large	90cm / 180cm / 270cm	£18.06 / £36.12 / £54.18	£22.65 / £45.30 / £67.95	£16.25 / £32.50 / £48.75	£20.39 / £40.78 / £61.17
17mm Small	90cm / 180cm / 270cm	£16.87 / £33.74 / £50.61	£21.95 / £43.90 / £65.85	£15.18 / £30.36 / £45.54	£19.76 / £39.52 / £59.28
17mm Medium	90cm / 180cm / 270cm	£17.64 / £35.28 / £52.92	£23.24 / £46.48 / £69.72	£15.88 / £31.76 / £47.64	£20.92 / £41.84 / £62.76
17mm Large	90cm / 180cm / 270cm	£19.91 / £39.82 / £59.73	£25.51 / £51.02 / £79.53	£17.92 / £35.84 / £53.76	£22.96 / £45.92 / £68.88

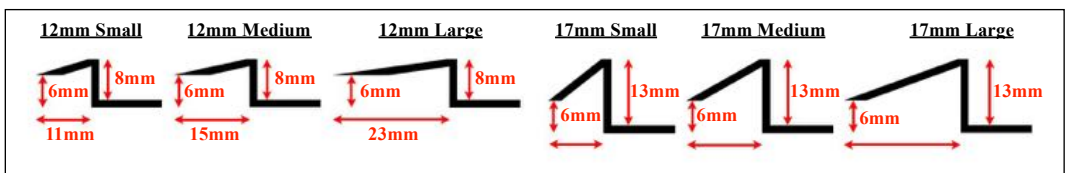

Carriage paid on 5 and over. Less than 5, add £7.50 for carriage, unless ordered with other items.



## Product

- The Premier Matwells (floating) uses a base material of solid brass for a high-quality installation.
- Available lengths: 90cm, 180cm and 270cm.

## Fitting

- See our fitting video on Stairrods YouTube channel.
- Suitable for: floating LVT, WPC/SPC, Engineered Wood Flooring, Timber Flooring and Laminates.
- Use the flooring to create a void.
- Use a non-expanding cartridge adhesive e.g. Stycco Flex or similar. Can be mechanically fixed when the adhesive has set.
- See our guide below regarding build-up. This is a guide for the estimator with a built in tolerance of 1-2mm from the lip to the floor (adhesive, floor level etc).
- Heights above 12mm suggest 50mm (2") centres.
- Consult the flooring manufacturer regarding expansion requirements on floating floors.

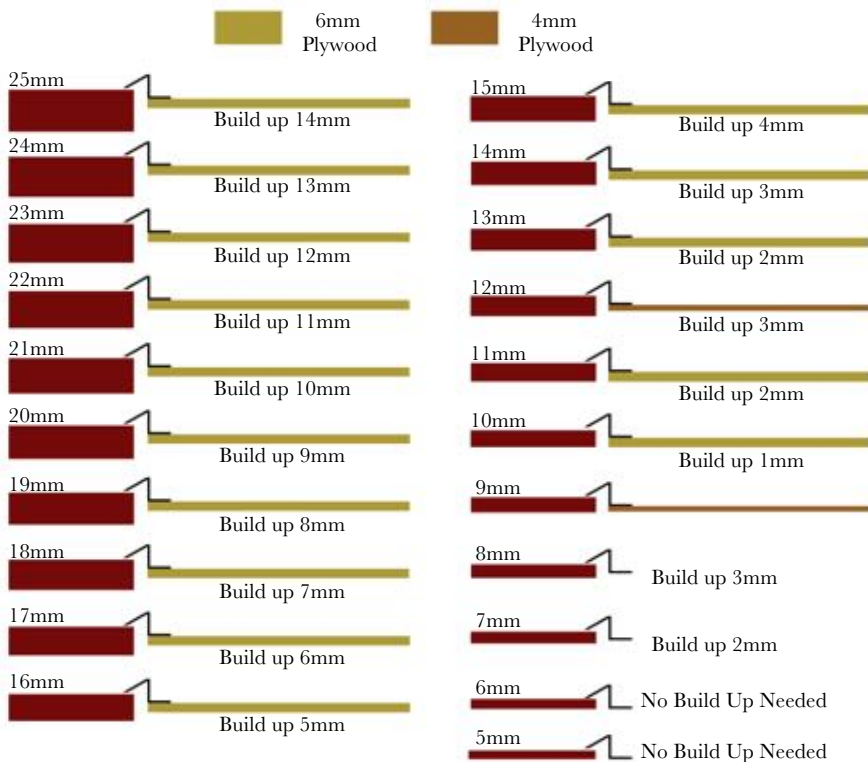

**Cleaning Guide, See page 112**



- Ali Top Nose for use with 7-8mm laminate to a carpeted stair.
- Pre-drilled middle and back edge.

### Ali Top Nose Prices

		Individual Price	50 Price (Any Trims)
<b>Ali Top Nose</b>	<b>90cm</b>	£7.98	£7.18
	<b>180cm</b>	£15.96	£14.36
	<b>270cm</b>	£23.94	£21.54

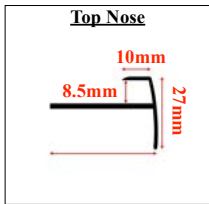

Carriage paid on 5 and over. Less than 5, add £7.50 for carriage, unless ordered with other items.



## **Product**

- The Ali Top Nose uses a base material of aluminium for a high-quality installation.
- Available lengths: 90cm, 180cm and 270cm.

## **Fitting**

- Use in conjunction with our Easyshims, the carpet on the riser can be adhered for a secure fix (detail below). This continues the waterfall look of the carpet on the steps below.
- 7-8mm Laminate can be used with 2mm underlay or use 2mm MDF spacers (supplied) for thicker underlay systems. Pre-drilled and countersunk at 150mm (6") centres and supplied with Spax-M self-drilling screws (do not pre-drill).
- Requires a T20 star bit.

ANY QUESTIONS  
Please call 01207 591176 For friendly expert advice.

## **See some installation examples below**

Top Nose fitted with 2mm Underlay and Easyshim's to the riser

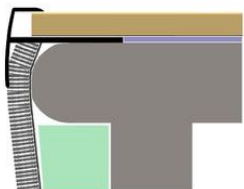

Top Nose fitted with 2mm MDF Strip, 4mm Underlay and Easyshim's to the riser

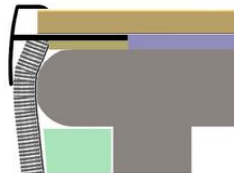

**Cleaning Guide, See page 112**



# AliTrims

The following pages are all about *Installing flooring in our trims.*

So, what does this mean? Well rather than trying to find a trim that matches the flooring, we use flooring. Sounds simple and yes, it is!

Tramline Trims can be used for all LVT and Laminates!

Wrap Nosings can be used for all LVT and all WPC/SPC.

What do we need to know?

Most WPC/SPC will peel or plane as below pictures.



Laminates 8mm 10mm etc will do this in 7 minutes!





# AliTrims

Ali Wrap Nosing & Tramline End Profile



Tramline Transition



TramlineZ



Ali Wrap Nosing & Tramline End Profile



Ali Wrap Nosing & Tramline End Profile



Tramline Transition & Tramline End Profile

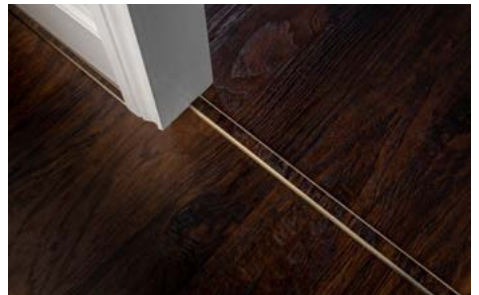



# Ali Wrap Nosing

Installing floors in our trims



Available from  
October 2019

- New Ali Wrap Nosing is available in 5 options.
- Wrap Nosing for LVP/LVT 2.5mm and 3mm on 6mm plywood prep.
- Wrap Nosing for 8mm and 6.5mm WPC (multi layered flooring) Flush and Overlap.
- Pre drilled

## Wrap Nosing Prices

Profile Type	Size	Individual Price	50 Price
LVT Nosing	90cm	£7.98	£7.18
	180cm	£15.96	£14.36
	270cm	£23.94	£21.54
8mm WPC Flush Nosing	90cm	£8.72	£7.85
	180cm	£17.44	£15.70
	270cm	£26.16	£23.55
8mm WPC Overlap Nosing	90cm	£9.48	£8.53
	180cm	£18.96	£17.06
	270cm	£28.44	£25.59
6.5mm WPC Flush Nosing	90cm	£8.22	£7.40
	180cm	£16.44	£14.80
	270cm	£24.66	£22.20
6.5mm WPC Overlap Nosing	90cm	£9.20	£8.28
	180cm	£18.40	£16.56
	270cm	£27.60	£24.84



Ali Brass



Ali Antique



Ali Chrome



Ali Black

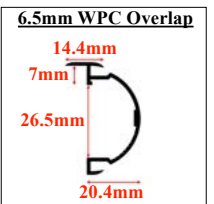
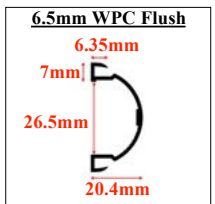
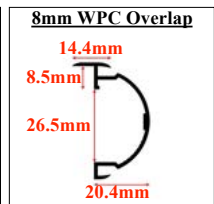
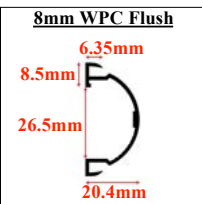
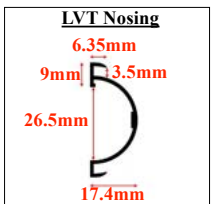

Carriage paid on 5 and over. Less than 5, add £7.50 for carriage, unless ordered with other items.



## Product

- The Ali Wrap Nosing uses a base material of aluminium for a high-quality installation.
- Available lengths: 90cm, 180cm and 270cm.

## Fitting

- See our fitting videos on Stairrods YouTube channel: fitting LVT and WPC/SPC.
- The Wrap Nosing is available for LVT 2.5mm or 3mm dryback (glue down) and requires 6mm plywood prep.
- The Wrap Nosing is available for WPC 8mm and WPC/SPC 6.5mm either Flush or Overlap (for the top step allowing expansion).
- Use the top layer to form the curve.
- Fits to existing bullnose (overhang) tread without squaring off the nosing or building out the riser.
- Designed for 22mm-25mm tread thickness.
- Use Stycco Flex adhesive or similar.
- Supplied with pre-attached adhesive tape for the LVT inlay.
- Pre-drilled and countersunk at 100mm (4") centres and supplied with Spax-M self-drilling screws (do not pre-drill). Requires a T20 star bit.
- Suitable for returns (mitres).

ANY QUESTIONS  
Please call 01207 591176 For friendly expert advice.

## See some installation examples below

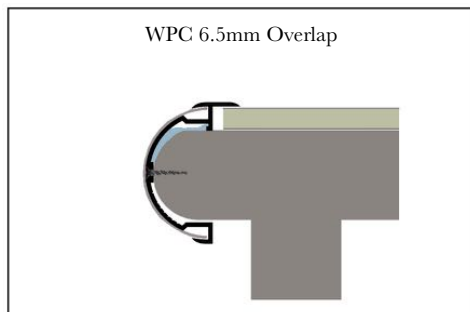
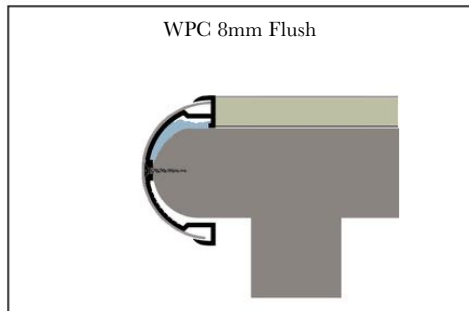
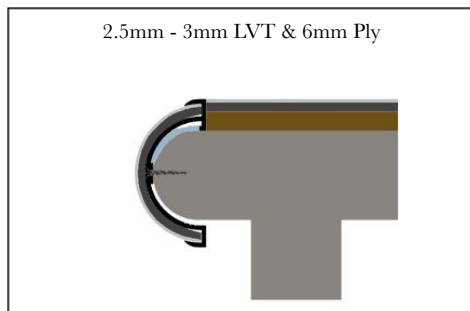

**Cleaning Guide, See page 112**



**Available from  
October 2019**

- Ali Bendybull is an attractive stair nosing for curved/curtail treads and straight steps between 22mm-25mm thickness.
- For use with LVT 2-3mm and WPC/SPC (any multi-layered flooring) and Floating LVT planed down.
- Can be used on all steps **or** in conjunction with our Wrap Nosing which has an overlap option required for the top step requiring expansion for WPC/SPC.

**Ali Bendybull Prices**

Profile Type	Size	Individual Price	50 Price
Ali Bendybull	90cm	£10.98	£9.88
	180cm	£21.96	£19.76
	270cm	£32.94	£29.64

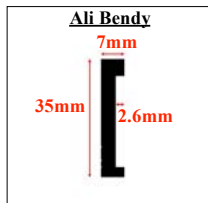



## **Product**

- The Ali Bendybull uses a base material of aluminium for a high-quality installation.
- Available lengths: 90cm, 180cm and 270cm..

## **Fitting**

- Ali Bendybull is available with a 3mm recess.
- Suitable for LVT 2-3mm and Floating LVT planed down with plywood prep and WPC/SPC 6.5-8mm with no plywood.
- Can be used on all steps **or** in conjunction with our Wrap Nosing (8 or 6.5mm) which has an overlap option required for the top step requiring expansion for WPC/SPC and Floating LVT (with underlay).
- See our fitting video on Stairrods YouTube channel for Bendybull full install, Bendybull light commercial and Bendybull with WPC/SPC
- Pre-drilled/countersunk at 75mm centres and supplied with Spax-M self-drilling screws (do not pre-drill). Requires a T20 star bit.
- Use a dim strip or strip of vinyl for an exact measure.
- We advise the use of a non expanding cartridge adhesive such as F-Ball & Co's Stycco Flex as a secondary fixing.
- We advise against mitring the Bendybull as it will produce a sharp corner. Consider Ali Wrap Nosings as an alternative.
- Consider 4mm ply with thinner SPC.
- For steep steps consider 4mm ply rather than 6mm to drop the height of the nosing.

## **See some installation examples**

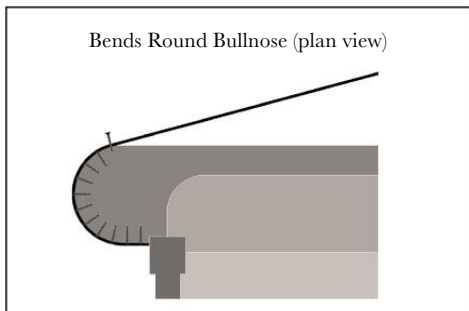
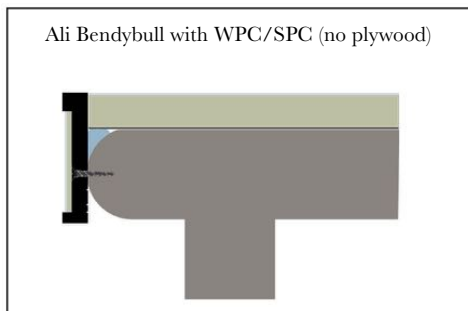
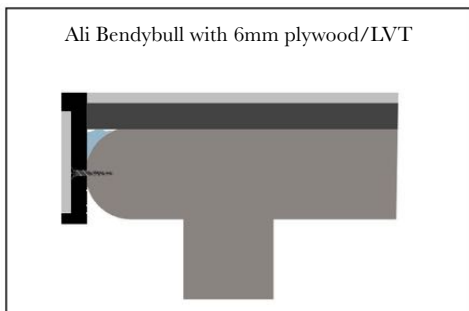

**Cleaning Guide, See page 112**



- An alternative to ‘T’ mouldings.
- New Tramline Transition is available in 3 recess options: 1mm, 3mm and 5mm.
- For WPC/SPC (1mm), LVT 2-3mm (3mm), and Floating LVT/Click/planned down Laminate (5mm).
- Includes offset pre-attached adhesive tape for the floor and the recess.
- For use with floating or non-floating **level** floors.

## Tramline Transition Prices

Profile Type	Size	1 +	10 +	50 +	100 +
<b>1mm Recess</b>	<b>180cm</b>	£7.53 Each	£5.53 Each	£4.98 Each	£4.48 Each
<b>3mm Recess</b>	<b>180cm</b>	£8.69 Each	£6.69 Each	£5.92 Each	£5.33 Each
<b>5mm Recess</b>	<b>180cm</b>	£10.58 Each	£8.58 Each	£7.97 Each	£7.17 Each

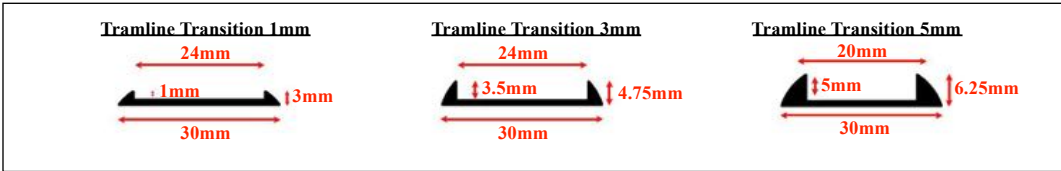

Carriage paid on 5 and over. Less than 5, add £7.50 for carriage, unless ordered with other items.



## **Product**

- The Ali Tramline Transition uses a base material of aluminium for a high-quality installation.
- Available length 180cm.

## **Fitting**

- Tramline Transition is available in 3 recess options: 1mm, 3mm and 5mm.
- Tramline 1mm (recess) for use with WPC/SPC flooring. Install flooring into the 24mm recess by peeling off the top layer. May require heat. See our fitting video on Stairrods YouTube channel.
- Tramline 3mm (recess) for LVT 2-3mm When installed using a recommended underlay system requiring expansion. Install flooring into the 24mm recess.
- Tramline 5mm (recess) for Floating LVT/Click 4-5mm flooring and Laminate flooring by planing off the back. Install flooring into the 20mm recess.
- Includes offset pre-attached adhesive tape for fitting to the floor and the recess.
- Surface may require additional preparation prior to adhering the trim.
- See our fitting video on Stairrods YouTube channel showing how strong this install is.

ANY QUESTIONS  
Please call 01207 591176 For friendly expert advice.

## **See some installation examples below**

1mm allows 16mm expansion



3mm allows 16mm expansion



5mm allows 16mm expansion





Available from  
November 2019

- A perfectly matched joiner from carpet to hard flooring.
- New TramlineZ is available in 2 recess options: 1mm and 3mm.
- For WPC/SPC (1mm), LVT 2-3mm (3mm) and Floating LVT/Click and Laminate flooring planed down.
- Includes pre-attached adhesive tape for the floor and the recess.

## Ali TramlineZ Prices

Profile Type	Size	1 +	10 +	50 +	100 +
1mm Recess	180cm	£ Each	£ Each	£ Each	£ Each
3mm Recess	180cm	£ Each	£ Each	£ Each	£ Each



Ali Brass



Ali Antique



Ali Chrome



Ali Black

**TramlineZ 1mm Recess**

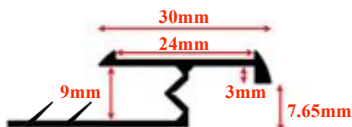

**TramlineZ 3mm Recess**

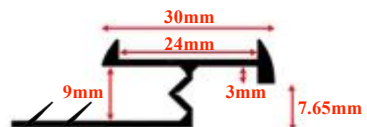

Carriage paid on 5 and over. Less than 5, add £7.50 for carriage, unless ordered with other items.



## **Product**

- The Ali TramlineZ uses a base material of aluminium for a high-quality installation.
- Available length 180cm.

## **Fitting**

- Used for stretch-fit carpets, medium height, to LVT and WPC/SPC 8-6mm and 8mm Laminate.
- TramlineZ is available in 2 recess options: 1mm and 3mm.
- TramlineZ 1mm (recess) is for use with WPC/SPC (any multi-layered flooring) by peeling off the top layer. See our fitting video on Stairrods YouTube channel.
- TramlineZ 3mm (recess) for LVT 2-3mm and Floating LVT/Click 4-5mm and Laminate flooring by planing down to 3mm.
- Install flooring into the recess.
- Includes pre-attached adhesive tape.
- Includes MDF spacer 40cm long. Cut in short lengths and place under nail holes to raise base.
- Consider underlay and carpet thickness as this will have a bearing on the heights.
- The trim should start a few millimetres above the height of the flooring to allow a 2-4mm level nap down to give the carpet a firm grip on the pins.
- Use the MDF strips provided to raise the base 3mm.
- Use a block of wood wrapped in carpet and then gently hammer down the trim making it level, never at an angle.

ANY QUESTIONS  
Please call 01207 591176 For friendly expert advice.

**See an installation example below**

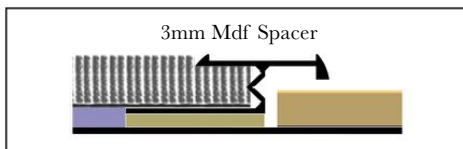



# Ali Tramline Reducer

Installing floors in our trims



Available from  
November 2019

- A perfectly matched reducer/ramp which can accommodate height differences from 2-9mm.
- New Tramline Reducer is available in 2 recess options: 1mm and 3mm.
- For WPC/SPC (1mm), LVT 2-3mm (3mm) and Floating LVT/Click (planed down).
- Includes pre-attached adhesive tape for the floor and the recess.
- For use with floating or non-floating floors.

## Tramline Reducer Prices

Profile	Length	1 +	10 +	50 +	100 +
2-3mm 1mm Recess	180cm	£8.58	£6.58	£5.92	£5.33
4-5mm 1mm Recess	180cm	£9.24	£7.24	£6.52	£5.87
6-7mm 1mm Recess	180cm	£10.05	£8.05	£7.25	£6.53
8-9mm 1mm Recess	180cm	£11.62	£9.62	£8.66	£7.79
2-3mm 3mm Recess	180cm	£9.35	£7.35	£6.62	£5.96
4-5mm 3mm Recess	180cm	£9.88	£7.88	£7.09	£6.38
6-7mm 3mm Recess	180cm	£10.89	£8.89	£8.00	£7.20
8-9mm 3mm Recess	180cm	£12.50	£10.50	£9.45	£8.51

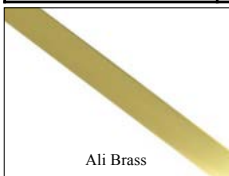

Ali Brass



Ali Antique

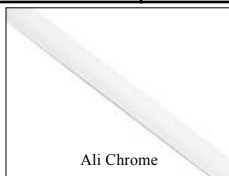

Ali Chrome

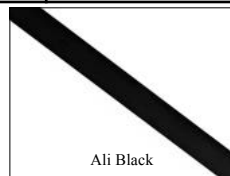

Ali Black

### Reducer 2-3mm 1mm Recess    Reducer 4-5mm 1mm Recess    Reducer 6-7mm 1mm Recess    Reducer 8-9mm 1mm Recess

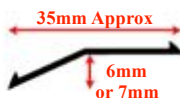

### Reducer 2-3mm 3mm Recess    Reducer 4-5mm 3mm Recess    Reducer 6-7mm 3mm Recess    Reducer 8-9mm 3mm Recess



Carriage paid on 5 and over. Less than 5, add £7.50 for carriage, unless ordered with other items.



## **Product**

- The Ali Tramline LVT Reducer uses a base material of aluminium for a high-quality installation.
- Available lengths 180cm.

## **Fitting**

- New Tramline Reducer is available in 2 recess options: 1mm and 3mm.
- For WPC/SPC (1mm), LVT 2-3mm (3mm) and Floating LVT/Click planed down.
- Tramline 1mm (recess) for use with WPC/SPC (any multi-layered flooring). Install flooring into the recess by peeling off the top layer. May require heat.
- Tramline 3mm (recess) for LVT 2-3mm when installed using a recommended underlay system requiring expansion and Floating LVT/Click 4-5mm flooring by planing down. Install flooring into the recess. 'P' groove the back of the LVT to allow for ramp.
- Four height options are available: 2-3, 4-5, 6-7, 8-9mm.
- As an example, simply turn the trim around to provide either a 2 or 3mm drop.
- Includes pre-attached adhesive tape for fitting to the floor and the recess.
- Surface may require additional preparation prior to adhering the trim.
- See our fitting video on Stairrods YouTube channel showing how strong this install is.

ANY QUESTIONS  
Please call 01207 591176 For friendly expert advice.

**See some installation examples below**

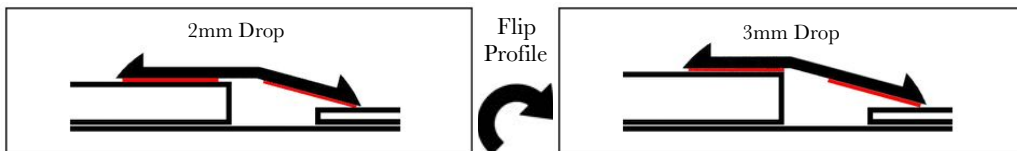



# Ali Tramline End Profile

Installing floors in our trims

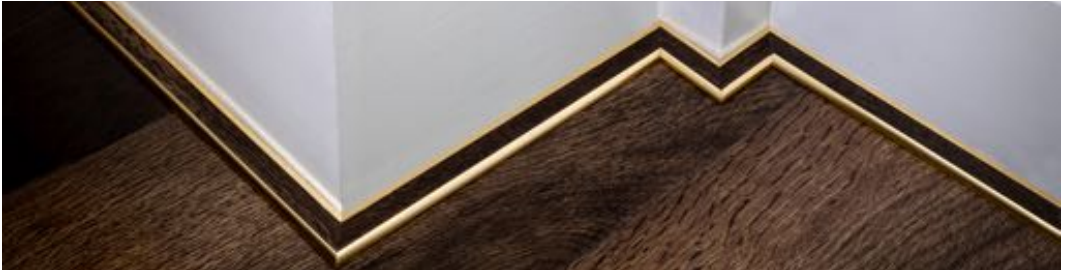

- Alternative to scotia, base shoe, quarter round.
- New Tramline End Profile is available in 3 recess options: 1mm, 3mm and 5mm.
- For WPC/SPC (1mm), LVT 2-3mm (3mm), and Floating LVT/Click/planned down Laminate (5mm).
- Includes pre-attached adhesive tape for the skirting/base board and the recess.

## Ali Tramline End Profile Prices

Profile Type	Size	1 +	10 +	50 +	100 +
1mm Recess	180cm	£5.81 Each	£3.81 Each	£3.43 Each	£3.09 Each
3mm Recess	180cm	£7.32 Each	£5.32 Each	£4.79 Each	£4.31 Each
5mm Recess	180cm	£8.40 Each	£6.40 Each	£5.76 Each	£5.18 Each



Ali Brass



Ali Antique



Ali Chrome



Ali Black

### End Profile 1mm

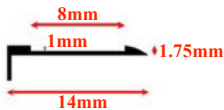

### End profile 3mm

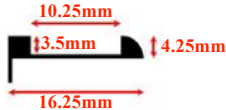

### End Profile 5mm

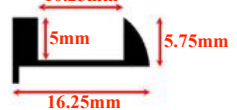

Carriage paid on 5 and over. Less than 5, add £7.50 for carriage, unless ordered with other items.



## **Product**

- The Ali Tramline End profile uses a base material of aluminium for a high-quality installation.
- Available length 180cm.

## **Fitting**

- Tramline End Profile is available in 3 recess options: 1mm, 3mm and 5mm.
- Tramline 1mm (recess) for use with WPC/SPC (any multi-layered flooring). Install flooring into the 8mm recess by peeling off the top layer. May require heat.
- Tramline 3mm (recess) for LVT 2-3mm when installed using a recommended underlay system. Install flooring into the 10mm recess.
- Tramline 5mm (recess) for Floating LVT/Click 4-5mm flooring and Laminate flooring by planing off the back.
- Includes pre-attached adhesive tape for the skirting/base board and the recess.
- Surface may require additional preparation prior to adhering the trim.
- For installation advice see our fitting video on Stairrods YouTube channel.

ANY QUESTIONS  
Please call 01207 591176 For friendly expert advice.

## **See some installation examples below**

1mm recess allows 10mm expansion



3mm recess allows 12mm expansion

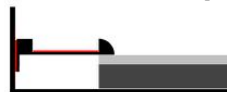

5mm recess allows 12mm expansion

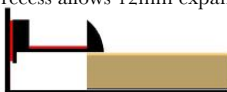



**Available from  
November 2019**

- An attractive pipe cover to match your WPC/SPC, LVT, Floating LVT, Laminate and Engineered Floors.

## Pipe Cover Prices

Profile Type	1 +	16 +	50 +	100 +
3mm Recess	£4.38 Each	£2.38 Each	£2.14 Each	£1.93 Each
5mm Recess	£4.45 Each	£2.45 Each	£2.21 Each	£1.98 Each
8mm Recess	£ Each	£ Each	£ Each	£ Each
10mm Recess	£ Each	£ Each	£ Each	£ Each
12mm Recess	£ Each	£ Each	£ Each	£ Each
15mm Recess	£ Each	£ Each	£ Each	£ Each

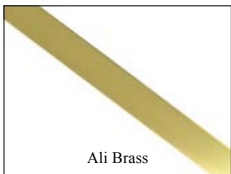

Ali Brass



Ali Antique

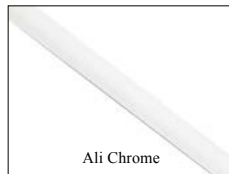

Ali Chrome

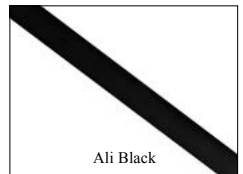

Ali Black

Carriage paid on 16 and over. Less than 16, add £7.50 for carriage, unless ordered with other items.



## **The Product**

- The LVT Radiator Pipe Covers uses a base material of a metal alloy for a high-quality installation.

## **Fitting**

- Six options available for: WPC/SPC, LVT 2-3mm, Floating LVT 4-5mm, Laminate 8 -12mm and Engineered Floors 14mm.
- Simply slots together and loose laid.
- Fits a 15mm radiator pipe.
- Allows expansion gap.
- Install relevant LVT in the recess.

ANY QUESTIONS  
Please call 01207 591176 For friendly expert advice.

	Minimum Clearance Needed	Maximum Expansion Hole
Ali Pipe Covers	16mm	44mm

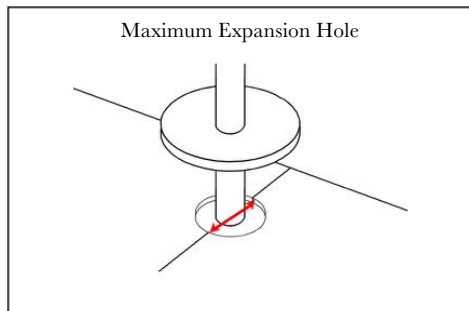
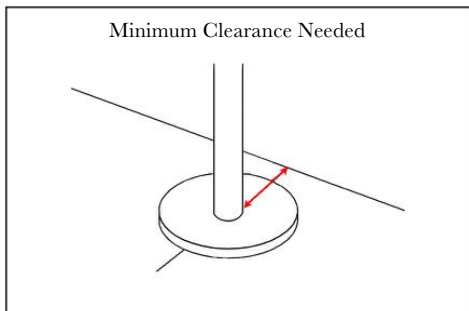



- Available in Standard and Specialised colours.
- Available in cut lengths from 15m to 50m
- Available in 50m spools
- Note: Spools may contain joins.

## Easybind Prices

Available in Standard Colours (ST) and Specialised Colours (SP)	Standard	Specialised
15m-50m lengths. <i>Available in smaller quantities with a £7.50 carriage charge.</i>	£2.77 per metre	£3.77 per metre
50m spool.	£2.26 per metre	£3.26 per metre
2 x 50m spool.	£2.02per metre	£3.02 per metre



Beige, Black & Brown



Beige, Black & Brown



Blue, Green & Grey



Blue, Green & Grey



Pinks & Red



Multi Colour



Multi Colour



Specialised



Specialised



## The Product

- Easybind is a simple but effective alternative to whipping carpet edges on stair runners and rugs. Easybind can be fitted to the carpet on site so no delays in waiting for the carpet to be whipped.

### Easybind Carpet Edging For Carpet Runners and Rugs.

- Simply measure the edges of the carpet where you will be fitting the Easybind and allow a little extra then cut accordingly.

## Easybind Accessories

Easybind Starter Kit contains the following: <ul style="list-style-type: none"> <li>• 1 Easybind glue gun, 10 Easybind glue sticks</li> <li>• Easybind swatch box</li> <li>• Easybind long nozzle - A sample jar of Easystuds.</li> <li>• 35 short lengths of Easybind showing all 35 colours.</li> <li>• 'Try Me' 1 metre length of Easybind.</li> <li>• A small roll of Sellotape to make your first cut.</li> </ul>	<b>£30.00</b>
Easybind long nozzle for glue gun	<b>£9.79</b>
Easybind glue gun with long nozzle	<b>£26.78</b>
Easybind hot melt glue sticks (5kg)	<b>£31.30</b>



Prepare the carpet edges by cutting with a sharp knife to produce a clean cut. Be aware of any surface below the carpet when cutting so as not to cause damage.

Easybind will fray when cut so to prevent this apply adhesive tape around the rope at the cutting point.



Always start in the middle of a straight run as it is easier to produce a clean join on a straight section as opposed to a curve or corner. Peel backing off the adhesive tape.

Be sure to run the rope edging parallel to the carpet edge leaving a gap to accommodate the glue gun nozzle.

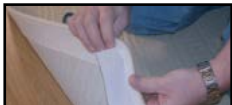

When going around an outside corner cut the binding not the rope and fold underneath, the same applies to an inside corner without the need to fold the binding on the back.

When creating a joint apply adhesive tape to the area that will be cut, this prevents the rope edging from fraying when being cut.



After cutting match the rope pieces together. **TIP:** Have the ends of the adhesive tape visible to allow ease of removal. Seal the two pieces of rope with a spot of hot glue and peel the tape away.



When you are happy with the join and the corners etc. Use the hot glue gun to apply a bead of glue between the binding and the carpet backing, pinching together as you go. Be careful not to get glue on the carpet.

For longer runs try a piece of 3" x 2" to help attach large sections of the binding. Use a glue gun pad when the gun is not in use to avoid glue dripping onto either the floor or carpet.





## G9 Geordie Gripper Prices

1 box (50 metres)	£20.99 per box
3 boxes (150 metres)	£19.99 per box
10 boxes (500 metres)	£18.99 per box

- 9mm Gripper for deep underlays.
- 9mm high and 28mm wide.
- 24mm wood nails only.
- Pin height 4.5mm.
- 50 metres in a box.
- Use deep, high quality underlay where required without compromising on carpet grip.
- No waterfall effect when using deep underlays.
- No more shimming up standard gripper to gain height.
- Our 24mm nails allow you to get a full 'Nail Grip' into the floor.
- Sell as a package with thicker underlay.
- Quicker install.

**Carriage paid on 3 and over on the G9 Geordie Gripper.  
Less than 3, add £7.50 for carriage, unless ordered with other items.**

*New*

## G6 Chopped Up Gripper Prices

150 metres (supplied in 2 boxes)	£38
----------------------------------	-----

**Available from November 2019**

- G6 Chopped Up Geordie Gripper 150mm 6" (6mm by 25mm)
- Chopped to British Standard lengths.



Pallet prices available



## **Post Fitting**

Premier Trims should always be fitted with the protective tape on.

If the Premier Trim has been fitted without the tape. It's best to give a quick wipe with White vinegar.

## **Brass**

Remove spills immediately to limit corrosion with White vinegar. Brass will tarnish over time and we recommend a polishing cloth such as HG copper shine cloth available from most DIY stores. Avoid contact with floor coverings.

Should corrosion appear, we use a Mirka Total Finishing pad P1500 (grey). Rub the area to remove contamination and buff up with HG copper shine cloth. If in doubt, please email [sales@stairrods.co.uk](mailto:sales@stairrods.co.uk)

## **Satin Brass**

Remove spills immediately to limit corrosion with White vinegar. Brass will tarnish over time and we recommend a polishing cloth such as HG copper shine cloth available from most DIY stores. Avoid contact with floor coverings.

Should corrosion appear, we use a Mirka Total Finishing pad P1500 (grey). Rub the area to remove contamination and buff up with HG copper shine cloth. If in doubt, please email [sales@stairrods.co.uk](mailto:sales@stairrods.co.uk)

## **Antique bronze**

Remove spills immediately to limit corrosion with White vinegar. Brass will tarnish over time and we recommend a polishing cloth such as HG copper shine cloth available from most DIY stores. Avoid contact with floor coverings.

Should corrosion appear, we use a Mirka Total Finishing pad P1500 (grey). Rub the area to remove contamination and buff up with HG copper shine cloth. This may go down to the solid brass base however over time the 'rubbed' lighter area will tarnish/blend into the antique finish. If in doubt, please email [sales@stairrods.co.uk](mailto:sales@stairrods.co.uk)

## **Antique brass**

Remove spills immediately to limit corrosion with White vinegar. Brass will tarnish over time and we recommend a polishing cloth such as HG copper shine cloth available from most DIY stores. Avoid contact with floor coverings.

Should corrosion appear, we use a Mirka Total Finishing pad P1500 (grey). Rub the area to remove contamination and buff up with HG copper shine cloth. This may go down to the solid brass base however over time the 'rubbed' lighter area will tarnish/blend into the antique finish. If in doubt, please email [sales@stairrods.co.uk](mailto:sales@stairrods.co.uk)

## **Pewter**

Remove spills immediately to limit corrosion with White vinegar. Use a polishing cloth occasionally, such as HG copper shine cloth, available from most DIY stores. Avoid contact with floor coverings.

## **Chrome, Brushed Chrome, Satin Nickel, Polished Nickel and Black**

No maintenance required

# Point Of Sale Material



**Rods & Trims Sample Display**  
 £2 per Rod/Trim @ 24"  
 A Mix of Rods, Trims  
 Mounting Board not included



**Jubilee/Homepride Display**  
 - FOC



**Easybind Swatch Box**  
 - FOC



**Stair Rod Box**  
 - £20



**Bendybull Wholesaler Display**  
 - £50

# Point Of Sale Material



**Carpet Trim Box**  
- FOC



**Floor Trim Box**  
- FOC



**Carpet Board**  
- FOC



**Floor Board**  
- FOC



**Tramline Board**  
- FOC



**Premier Inlay Board**  
- FOC



**Decorative Pipe Cover Board**  
- FOC

# Social Media



@stairrods



@StairrodsUK



Search Stairrods UK



@StairrodsUK