



UK Trade Price List

1st October 2015

All Prices exclude VAT



Premier Ramps
Premier Little Nose
Premier T's
Premier Little Lip



New Colours and Rod types in Crystal and Vision Ranges.
Balladeer is now in the Country range and available in 16mm.
10 new colours of Easybind (8 specialised & 2 standard).
Slight price increase on Easyshims, Easystuds, Premier Lips and Stargrip.
Premier Trims available at 100cm with a 10% surcharge.

Stairrods (UK) Ltd.

Unit 6, Park Road North Ind. Est.,
Blackhill, Consett, Co. Durham DH8 5UN

Tel: +44 (0) 1207 591176

Fax: +44 (0) 1207 591911

Email: sales@stairrods.co.uk

www.stairrods.co.uk



Stair Rods

Page	Product
3	Royale
5	Eastern Promise
7	Crystal
9	Premier
11	Country
13	Vision
15	Tudor
17	Blacksmith
19	Jubilee
21	Homepride
23	Easyrod
25	Stargrip

Accessories

Page	Product
27	Victorian Stair Clips
29	Skiffer
30	Easystuds



Premier Trims, Easyshims & Joints

Page	Product
31	Easyshims
33	Easychocks & Easywedges
35	DoubleZ™9
37	DoubleZ™4
39	Single 9
41	Single 4
43	Square
45	Posh 30
47	Posh 38
49	Posh 55
51	Cover
53	Euro Cover
55	20mm Euro Cover & Vinyl Edge
57-59	Two-Way Ramps
61-62	Ramps
65	Lip
67	Little Lips
69	Little Nose
71	Little T
73	Big T
75	Joints

Carpet Edging

Page	Product
77	Easybind

Royale Stair Rods



- Available for runner and fully fitted carpets.
- Three finial designs: Beaumont, Louis, Vue.
- Seven finishes: Antique Brass, Black, Brass, Chrome, Pewter, Satin Brass and Satin Nickel.
- All finial designs are available in all colours in any combination.

Royale Prices

Hollow Triangular Rod	Runner	Fully Fitted
For any length up to 36" (91.5cm), thereafter add 55p/inch (2.5cm)	£25.46	£22.72



Vue Polished Brass



Louis Satin Brass



Beaumont Antique Brass



Beaumont Chrome



Louis Satin Nickel



Vue Black



Beaumont Pewter





Technical

The Product

- The Royale range of stair rods are available for either a runner carpet or fully fitted.
- The Royale range are made to measure, see below for measuring guidelines.

Royale Stair Rod For Carpet Runner.

- We recommend that you add 6 inches (15cm) to the width of your carpet and use this measurement to give you the tip to tip length of the stair rod.

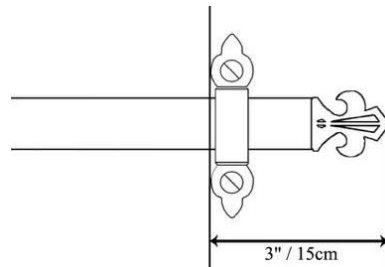

- Our standard runner bracket clearance is 10mm.

ANY QUESTIONS
Please call 01207 591176 For friendly expert advice.

Royale Rod For Fully Fitted Carpet.

- Depending on the width of the stair we recommend that you leave a 1 to 2 inch (2.5 to 5cm) gap between the stringboard and the tip of the rod at both sides of the staircase.

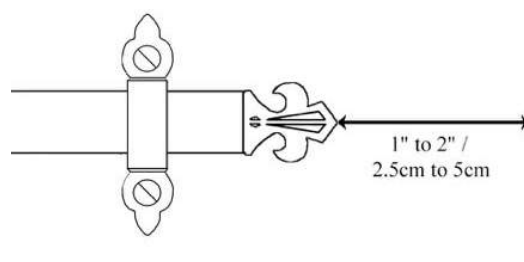

Fitting Rods To Stair.

- Both runner and fully fitted brackets are supplied with number 6 screws and you must drill a pilot hole before fixing the brackets to the stair. For softwood create a 2.5mm pilot hole and for hardwood create a 3mm hole. A clearance hole of 4mm should be drilled to accommodate the screw shank. Remember to set your power drill on a low torque setting to avoid breaking the screws. For fully fitted carpets the supplied bracket sits on top of the rod and screws fix it through the carpet.

Care and Maintenance

- We recommend using a damp cloth to keep the rods clean, any household cleaners used to clean the wood and paint work of the staircase should be applied to the cloth and not directly onto the surface of the stair, as over spray can cause a speckled tarnish on the rods. If any liquids are inadvertently spilt on the stair rods they should be cleaned immediately with a damp cloth and dried with a clean cloth.



- Available in three rod styles: Plain, Reeded and Spiral, for runner and fully fitted carpets.
- Three finial designs: Dubai, Cairo, and Dune.
- Ten finishes: Antique Brass, Antique Bronze, Black, Brass, Brushed Chrome, Chrome, Pewter, Polished Nickel, Satin Brass and Satin Nickel.
- All finial designs are available in all colours and rod styles in any combination.

Eastern Promise Prices

Hollow 5/8" Rod	Runner	Fully Fitted
PLAIN ROD 5/8" (16mm). For any length up to 36" (91.5cm), thereafter add 31p/inch (2.5cm)	£21.55	£18.87
SPIRAL OR REEDED 5/8" (16mm). For any length up to 36" (91.5cm), thereafter add 31p/inch (2.5cm)	£23.21	£21.04



Cairo Polished Brass Plain



Dubai Satin Brass Reeded



Dune Antique Spiral



Dubai Antique Bronze Plain



Dune Chrome Reeded



Cairo Brushed Chrome Spiral



Dune Polished Nickel Plain



Dune Satin Nickel Reeded



Cairo Black Spiral



Dubai Pewter Plain



The Product

- The Eastern Promise range of stair rods are available for either a runner carpet or fully fitted.
- The Eastern Promise range are made to measure, see below for measuring guidelines.

Eastern Promise Rod For Fully Fitted Carpet.

- We recommend that you leave a 2 inch (5cm) gap between the stringboard and the tip of the rod at both sides of the staircase. The Eastern Promise range are made to measure, see below for measuring guidelines.

Eastern Promise Stair Rod For Carpet Runner.

- We recommend that you add 6 inches (10cm) when choosing the Cairo or Dubai finial, to the width of your carpet and use this measurement to give you the tip to tip length of the stair rod. If choosing the Dune finial add 5 inches. **NOTE: Tip to tip measurement includes the finials.**

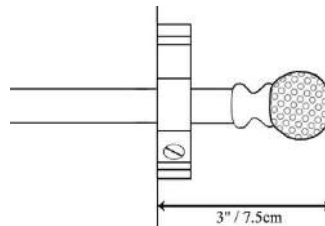

- Our standard runner bracket for this range has a clearance of 16mm however if you have either a deep pile carpet or thin carpet please call for advice.

ANY QUESTIONS
Please call 01207 591176 For friendly expert advice.

Eastern Promise Rod For Fully Fitted Carpet.

- Depending on the width of the stair we recommend that you leave a 1 to 2 inch (2.5 to 5cm) gap between the stringboard and the tip of the rod at both sides of the staircase.

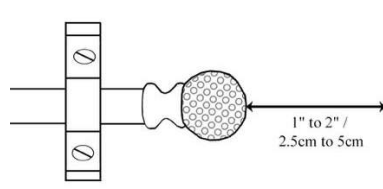

Prepare Hinge Brackets For fitting

- The brackets for runner carpets are hinged and consist of a bottom and top section and cannot be mixed with the top or bottom of other brackets. To fit the brackets the top and bottom must be separated to allow access to the screw holes. This requires little effort and is accomplished by removing the dome head screw and placing your thumbs on the hinge part of the bracket and first two fingers on the inside of the top and bottom and gently ease open the bracket. This will loosen the hinge and allow you to slide them apart.

Fitting Rods To Stair.

- Both runner and fully fitted brackets are supplied with number 6 screws and you must drill a pilot hole before fixing the brackets to the stair. For softwood create a 2.5mm pilot hole and for hardwood create a 3mm hole. A clearance hole of 4mm should be drilled to accommodate the screw shank. Remember to set your power drill on a low torque setting to avoid breaking the screws. With the hinged bracket separated fit the bottom half to the stair and put the rod in place then re fit the top half of the bracket by sliding the two half together, finally close with the dome head screw. For fully fitted carpets the supplied bracket sits on top of the rod and screws fix it through the carpet.

Care and Maintenance

- We recommend using a damp cloth to keep the rods clean, any household cleaners used to clean the wood and paint work of the staircase should be applied to the cloth and not directly onto the surface of the stair, as over spray can cause a speckled tarnish on the rods. If any liquids are inadvertently spilt on the stair rods they should be cleaned immediately with a damp cloth and dried with a clean cloth.



- Available in three rod styles: Plain, Reeded and Spiral, for runner and fully fitted carpets.
- Four crystal colours: Amber, Rainbow, Rose, Sky.
- Ten finishes: Antique Brass, Antique Bronze, Black, Brass, Brushed Chrome, Chrome, Pewter, Polished Nickel, Satin Brass and Satin Nickel.
- All finial designs are available in all colours and diameters in any combination.

Crystal Prices

Hollow 1/2" Rod	Runner	Fully Fitted
PLAIN ROD 1/2" (12mm). For any length up to 36" (91.5cm), thereafter add 25p/inch (2.5cm)	£13.94	£13.29
SPIRAL OR REEDED 1/2" (12mm). For any length up to 36" (91.5cm), thereafter add 25p/inch (2.5cm)	£16.06	£15.41

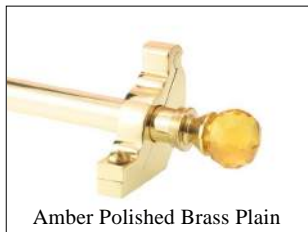

Amber Polished Brass Plain



Rainbow Satin Brass Reeded



Rose Antique Brass Spiral



Sky Antique Bronze Sky

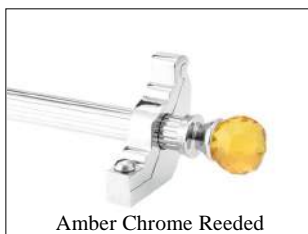

Amber Chrome Reeded



Rainbow Brushed Chrome Spiral



Rose Polished Nickel Plain



Sky Satin Nickel Reeded



Rainbow Black Plain



Amber Pewter Spiral



The Product

- The Crystal range of stair rods are available for either a runner carpet or fully fitted.
- The Crystal range are made to measure, see below for measuring guidelines.

Crystal Stair Rod For Carpet Runner.

- We recommend that you add 4 inches (10cm) to the width of your carpet and use this measurement to give you the tip to tip length of the stair rod. **NOTE: Tip to tip measurement includes the finials.**

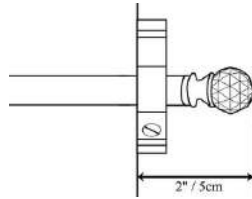

- Our standard runner bracket clearance is 14mm however if you have a deep pile carpet there is the option of using the 'High Clearance' bracket to give you 17mm clearance at a surcharge of £1.66 per rod.

Standard

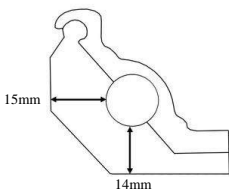

High Clearance

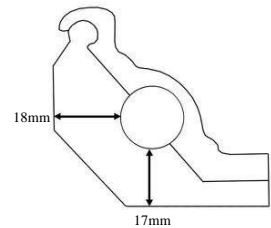

ANY QUESTIONS
Please call 01207 591176 For friendly expert advice.

Crystal Rod For Fully Fitted Carpet.

- Depending on the width of the stair we recommend that you leave a 1 to 2 inch (2.5 to 5cm) gap between the stringboard and the tip of the rod at both sides of the staircase.

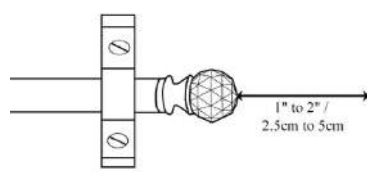

Prepare Hinge Brackets For fitting

- The brackets for runner carpets are hinged and consist of a bottom and top section and cannot be mixed with the top or bottom of other brackets. To fit the brackets the top and bottom must be separated to allow access to the screw holes. This requires little effort and is accomplished by removing the dome head screw and placing your thumbs on the hinge part of the bracket and first two fingers on the inside of the top and bottom and gently ease open the bracket. This will loosen the hinge and allow you to slide them apart.

Fitting Rods To Stair.

- Both runner and fully fitted brackets are supplied with number 6 screws and you must drill a pilot hole before fixing the brackets to the stair. For softwood create a 2.5mm pilot hole and for hardwood create a 3mm hole. A clearance hole of 4mm should be drilled to accommodate the screw shank. Remember to set your power drill on a low torque setting to avoid breaking the screws. With the hinged bracket separated fit the bottom half to the stair and put the rod in place then re fit the top half of the bracket by sliding the two half together, finally close with the dome head screw. For fully fitted carpets the supplied bracket sites on top of the rod and screws fix it through the carpet.

Care and Maintenance

- We recommend using a damp cloth to keep the rods clean, any household cleaners used to clean the wood and paint work of the staircase should be applied to the cloth and not directly onto the surface of the stair, as over spray can cause a speckled tarnish on the rods. If any liquids are inadvertently spilt on the stair rods they should be cleaned immediately with a damp cloth and dried with a clean cloth.



- Available in three diameters: 1/2" (12mm), 5/8" (16mm) and 3/4" (19mm).
- Six finial designs: Balmoral, Chatsworth, Lancaster, Hanover, Windsor and Woburn.
- Standard finishes: Antique Brass, Antique Bronze, Polished Brass and Satin Brass.
- Specialised finishes: Black, Brushed Chrome, Chrome, Pewter, Polished Nickel, and Satin Nickel.
- All finial designs are available in all colours and diameters in any combination.
- Hanover is not available in the 5/8" or 3/4".

Premier Prices

Solid Core Rods	Runner		Fully Fitted		Fully Fitted Side Fix	
	ST	SP	ST	SP	ST	SP
1/2" (12mm) For any length up to 36" (91.5cm), thereafter add 33p/inch (2.5cm)	£18.85	£22.85	£17.09	£21.09	£12.72	£16.72
5/8" (16mm) For any length up to 36" (91.5cm), thereafter add 47p/inch (2.5cm)	£25.60	£30.60	£23.52	£28.52	£17.47	£22.47
3/4" (19mm) For any length up to 36" (91.5cm), thereafter add 70p/inch (2.5cm)	£36.8	£42.80	N/A	N/A	N/A	N/A

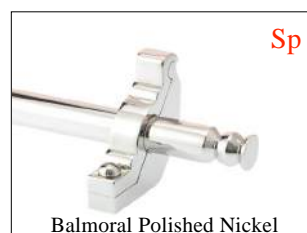



The Product

- The Premier range of stair rods are available for either a runner carpet or fully fitted and in three diameters for runners and two diameters for fully fitted, see facing page for details.
- The Premier range are made to measure, see below for measuring guidelines.

Premier Stair Rod For Carpet Runner.

- For 1/2" rods we recommend that you add 4 inches (10cm) to the width of your carpet and use this measurement to give you the tip to tip length of the stair rod, for 5/8" 5 inches (12.5cm) over and for 3/4" 6 inches (15cm) over.

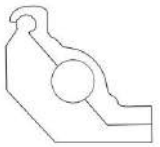

Standard 1/2"
14mm clearance

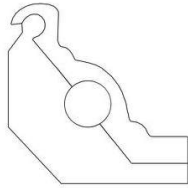

High Lift 1/2"
17mm clearance

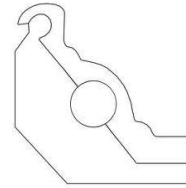
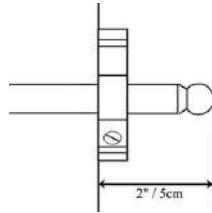

Standard 5/8"
15mm clearance

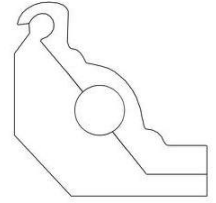

Standard 3/4"
18mm clearance

- If you have either a very deep or thin carpet please call for advise.

ANY QUESTIONS
Please call 01207 591176 For friendly expert advice.

Premier Rod For Fully Fitted Carpet.

- We recommend that you leave a 1 to 2 inch (2.5 to 5cm) gap between the stringboard and the tip of the rod at both sides of the staircase.

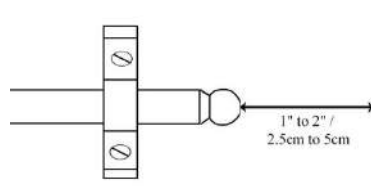

Prepare Hinge Brackets For fitting

- The brackets for runner carpets are hinged and consist of a bottom and top section and cannot be mixed with the top or bottom of other brackets. To fit the brackets the top and bottom must be separated to allow access to the screw holes. This requires little effort and is accomplished by removing the dome head screw and placing your thumbs on the hinge part of the bracket and first two fingers on the inside of the top and bottom and gently ease open the bracket. This will loosen the hinge and allow you to slide them apart.

Fitting Rods To Stair.

- Both runner and fully fitted brackets are supplied with number 6 screws and you must drill a pilot hole before fixing the brackets to the stair. For softwood create a 2.5mm pilot hole and for hardwood create a 3mm hole. A clearance hole of 4mm should be drilled to accommodate the screw shank. Remember to set your power drill on a low torque setting to avoid breaking the screws. With the hinged bracket separated fit the bottom half to the stair and put the rod in place then re fit the top half of the bracket by sliding the two half together, finally close with the dome head screw. For fully fitted carpets the supplied bracket sites on top of the rod and screws fix it through the carpet.

Care and Maintenance

- We recommend using a damp cloth to keep the rods clean, any household cleaners used to clean the wood and paint work of the staircase should be applied to the cloth and not directly onto the surface of the stair, as over spray can cause a speckled tarnish on the rods. If any liquids are inadvertently spilt on the stair rods they should be cleaned immediately with a damp cloth and dried with a clean cloth.



- Available in three rod styles: Plain, Reeded and Spiral, for runner and fully fitted carpets.
- Available in two diameters: 1/2" and 5/8".
- Four finial designs: Arran, Balladeer, Bordeaux and Sherwood.
- Ten finishes: Antique Brass, Antique Bronze, Black, Brass, Brushed Chrome, Chrome, Pewter, Polished Nickel, Satin Brass and Satin Nickel.
- All finial designs are available in all colours and diameters and rod styles in any combination.

Country Prices

Hollow Rod	Runner	Fully Fitted	Fully Fitted Side Fix
PLAIN ROD 1/2" (12mm) For any length up to 36" (91.5cm), thereafter add 25p/inch (2.5cm)	£13.94	£13.29	£9.84
SPIRAL OR REEDED 1/2" (12mm) For any length up to 36" (91.5cm), thereafter add 25p/inch (2.5cm)	£16.06	£15.41	£11.96
PLAIN ROD 5/8" (16mm) For any length up to up to 36" (91.5cm), thereafter add 31p/inch (2.5cm)	£20.08	£17.92	£13.61
SPIRAL OR REEDED 5/8" (16mm) For any length up to 36" (91.5cm), thereafter add 31p/inch (2.5cm)	£22.21	£20.08	£15.74



Bordeaux Polished Brass Plain



Balladeer Satin Brass Reeded



Arran Antique Brass Spiral



Sherwood Antique Bronze Plain



Arran Chrome Reeded

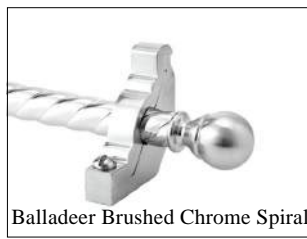

Balladeer Brushed Chrome Spiral

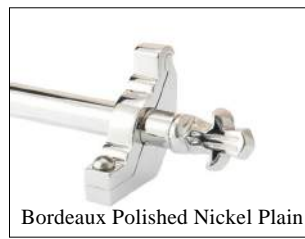

Bordeaux Polished Nickel Plain

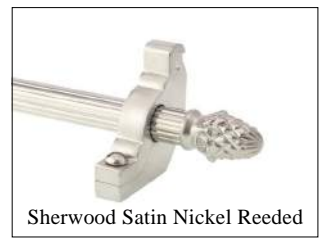

Sherwood Satin Nickel Reeded



Sherwood Black Plain



Arran Pewter Spiral



The Product

- The Country range of stair rods are available for either a runner carpet or fully fitted.
- The Country range are made to measure, see below for measuring guidelines.

Country Stair Rod For Carpet Runner.

- We recommend that you add 4 inches (10cm) to the width of your carpet and use this measurement to give you the tip to tip length of the stair rod. **NOTE: Tip to tip measurement includes the finials.**

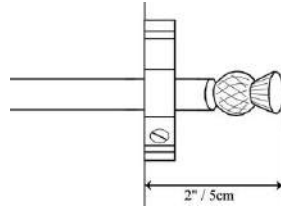

- Our standard runner bracket clearance is 14mm however if you have a deep pile carpet there is the option of using the 'High Clearance' bracket to give you 17mm clearance at a £1.66 surcharge. If you have a thinner carpet please call for advice.

Standard

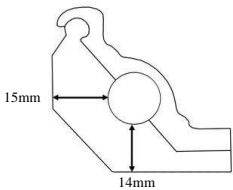

ANY QUESTIONS

Please call 01207 591176 For friendly expert advice.

High Clearance

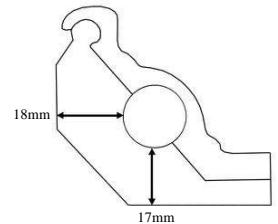

Country Rod For Fully Fitted Carpet.

- Depending on the width of the stair we recommend that you leave a 1 to 2 inch (2.5 to 5cm) gap between the stringboard and the tip of the rod at both sides of the staircase.

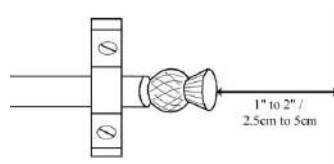

Prepare Hinge Brackets For fitting

- The brackets for runner carpets are hinged and consist of a bottom and top section and cannot be mixed with the top or bottom of other brackets. To fit the brackets the top and bottom must be separated to allow access to the screw holes. This requires little effort and is accomplished by removing the dome head screw and placing your thumbs on the hinge part of the bracket and first two fingers on the inside of the top and bottom and gently ease open the bracket. This will loosen the hinge and allow you to slide them apart.

Fitting Rods To Stair.

- Both runner and fully fitted brackets are supplied with number 6 screws and you must drill a pilot hole before fixing the brackets to the stair. For softwood create a 2.5mm pilot hole and for hardwood create a 3mm hole. A clearance hole of 4mm should be drilled to accommodate the screw shank. Remember to set your power drill on a low torque setting to avoid breaking the screws. With the hinged bracket separated fit the bottom half to the stair and put the rod in place then re fit the top half of the bracket by sliding the two half together, finally close with the dome head screw. For fully fitted carpets the supplied bracket sits on top of the rod and screws fix it through the carpet.

Care and Maintenance

- We recommend using a damp cloth to keep the rods clean, any household cleaners used to clean the wood and paint work of the staircase should be applied to the cloth and not directly onto the surface of the stair, as over spray can cause a speckled tarnish on the rods. If any liquids are inadvertently spilt on the stair rods they should be cleaned immediately with a damp cloth and dried with a clean cloth.



- Available in three rod styles: Plain, Reeded and Spiral, for runner and fully fitted carpets.
- Three finial designs: Arrow, Piston and Sphere.
- Ten finishes: Antique Brass, Antique Bronze, Black, Brass, Brushed Chrome, Chrome, Pewter, Polished Nickel, Satin Brass and Satin Nickel.
- All finial designs are available in all colours, diameters and rod styles, in any combination.

Vision Prices

Hollow 1/2" Rod	Runner	Fully Fitted
PLAIN ROD 1/2" (12mm). For any length up to 36" (91.5cm), thereafter add 25p/inch (2.5cm)	£16.06	£14.39
SPIRAL OR REEDED 1/2" (12mm). For any length up to 36" (91.5cm), thereafter add 25p/inch (2.5cm)	£18.18	£16.51



Arrow Polished Brass Plain



Piston Satin Brass Reeded



Sphere Antique Brass Spiral



Piston Antique Bronze Plain



Sphere Chrome Reeded



Arrow Brushed Chrome Spiral



Sphere Polished Nickel Plain



Arrow Satin Nickel Reeded





The Product

- The Vision range of stair rods are available for either a runner carpet or fully fitted.
- The Vision range are made to measure, see below for measuring guidelines.

Vision Stair Rod For Carpet Runner.

- We recommend that you add 4 inches (10cm) to the width of your carpet and use this measurement to give you the tip to tip length of the stair rod. **NOTE: Tip to tip measurement includes the finials.**

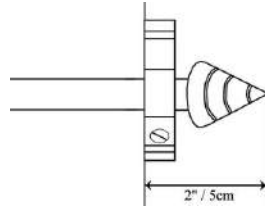

- Our standard runner bracket clearance is 14mm however if you have a deep pile carpet there is the option of using the 'High Clearance' bracket to give you 17mm clearance at a £1.66 surcharge. If you have a thinner carpet please call for advice.

Standard

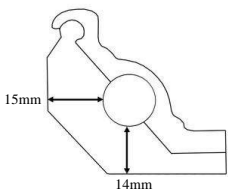

ANY QUESTIONS
Please call 01207 591176 For friendly expert advice.

High Clearance

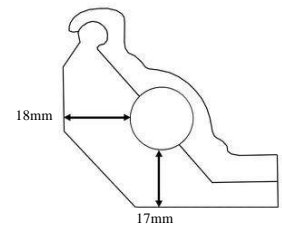

Vision Rod For Fully Fitted Carpet.

- Depending on the width of the stair we recommend that you leave a 1 to 2 inch (2.5 to 5cm) gap between the stringboard and the tip of the rod at both sides of the staircase.

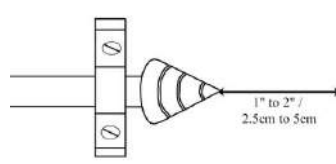

Prepare Hinge Brackets For fitting

- The brackets for runner carpets are hinged and consist of a bottom and top section and cannot be mixed with the top or bottom of other brackets. To fit the brackets the top and bottom must be separated to allow access to the screw holes. This requires little effort and is accomplished by removing the dome head screw and placing your thumbs on the hinge part of the bracket and first two fingers on the inside of the top and bottom and gently ease open the bracket. This will loosen the hinge and allow you to slide them apart.

Fitting Rods To Stair.

- Both runner and fully fitted brackets are supplied with number 6 screws and you must drill a pilot hole before fixing the brackets to the stair. For softwood create a 2.5mm pilot hole and for hardwood create a 3mm hole. A clearance hole of 4mm should be drilled to accommodate the screw shank. Remember to set your power drill on a low torque setting to avoid breaking the screws. With the hinged bracket separated fit the bottom half to the stair and put the rod in place then re fit the top half of the bracket by sliding the two half together, finally close with the dome head screw. For fully fitted carpets the supplied bracket sits on top of the rod and screws fix it through the carpet.

Care and Maintenance

- We recommend using a damp cloth to keep the rods clean, any household cleaners used to clean the wood and paint work of the staircase should be applied to the cloth and not directly onto the surface of the stair, as over spray can cause a speckled tarnish on the rods. If any liquids are inadvertently spilt on the stair rods they should be cleaned immediately with a damp cloth and dried with a clean cloth.



- Available for runner and fully fitted carpets.
- Two wood colours: Light and dark.
- Ten end detail and bracket finishes: Antique Brass, Antique Bronze, Black, Brass, Brushed Chrome, Chrome, Pewter, Polished Nickel, Satin Brass and Satin Nickel.
- All end detail finishes are available in both dark and light in any combination.

Tudor Prices

Available in Dark and Light	Runner	Fully Fitted
For any length up to 36" (91.5cm), thereafter add 23p/inch (2.5cm)	£13.56	£12.39



Polished Brass



Satin Brass



Antique Brass



Chrome



Satin Nickel



Black



Pewter





The Product

- The Tudor range of stair rods are available for either a runner carpet or fully fitted.
- The Tudor range are made to measure, see below for measuring guidelines.

Tudor Stair Rod For Carpet Runner.

- We recommend that you add 4 inches (10cm) to the width of your carpet and use this measurement to give you the tip to tip length of the stair rod.

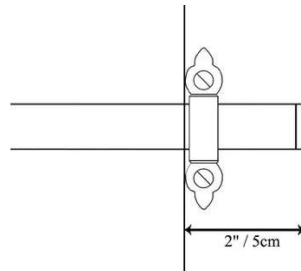

- Our standard runner bracket clearance is 10mm however if you have a deep pile carpet there is the option of using the 'Spacers' to give you more clearance. Please call for advice.

ANY QUESTIONS
Please call 01207 591176 For friendly expert advice.

Tudor Rod For Fully Fitted Carpet.

- Depending on the width of the stair we recommend that you leave a 1 to 2 inch (2.5 to 5cm) gap between the stringboard and the tip of the rod at both sides of the staircase.

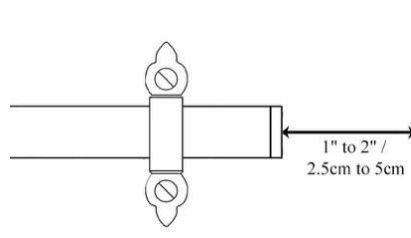

Fitting Rods To Stair.

- Both runner and fully fitted brackets are supplied with number 6 screws and you must drill a pilot hole before fixing the brackets to the stair. For softwood create a 2.5mm pilot hole and for hardwood create a 3mm hole. A clearance hole of 4mm should be drilled to accommodate the screw shank. Remember to set your power drill on a low torque setting to avoid breaking the screws. For fully fitted carpets the supplied bracket sits on top of the rod and screws fix it through the carpet.

Care and Maintenance

- We recommend using a damp cloth to keep the rods clean, any household cleaners used to clean the wood and paint work of the staircase should be applied to the cloth and not directly onto the surface of the stair, as over spray can cause a speckled effect on the lacquered rods. If any liquids are inadvertently spilt on the stair rods they should be cleaned immediately with a damp cloth and dried with a clean cloth.



- Available for runner and fully fitted carpets.
- Only available in Black.
- 3 finial designs: Ball, Flat and Spear
- Available in stock lengths (see below).
- Custom sizes available on request.

Blacksmith Prices

Hand beaten stair rods available in stock lengths only, from 24" (60.9cm) to 48" (121.9cm) in 2" (2.45cm) increments. Only available in black.

24" (60.9cm) to 40" (101.6cm) lengths	£12.84
42" (106.7cm) to 48" (121.9cm) lengths	£14.07





The Product

- The Blacksmith range of stair rods are available for either a runner carpet or fully fitted.
- The Blacksmith range are only available in stock lengths, see facing page.

Blacksmith Rod For Fully Fitted Carpet.

- We recommend that you leave a 2 inch (5cm) gap between the stringboard and the tip of the rod at both sides of the staircase.

Blacksmith Stair Rod For Carpet Runner.

- We recommend that you add 4 inches (10cm) to the width of your carpet when choosing the Ball or Flat end, then use this measurement to give you the tip to tip length of the stair rod. If choosing the Spear end add 6 inches (15cm).
- Because of the universal nature of the Blacksmith bracket it can be used on both deep pile and thin carpets.
- When used on a deep pile carpet the screw thread will be visible when viewed from the side.

ANY QUESTIONS
Please call 01207 591176 For friendly expert advice.

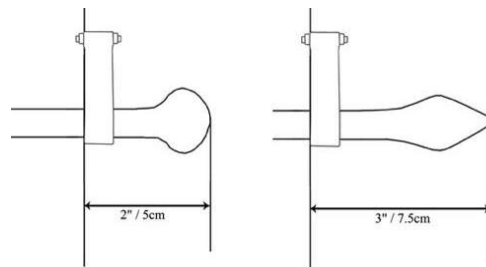

Blacksmith Rod For Fully Fitted Carpet.

- Depending on the width of the stair we recommend that you leave a 1 to 2 inch (2.5 to 5cm) gap between the stringboard and the tip of the rod at both sides of the staircase.

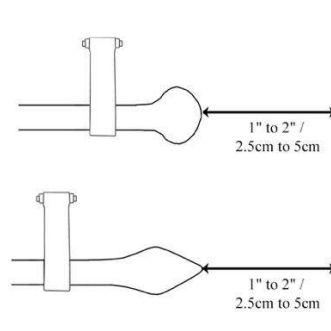

Fitting Rods To Stair.

- Both runner and fully fitted brackets are supplied with number 8 screws and you must drill a pilot hole before fixing the brackets to the stair. For softwood create a 3mm pilot hole and for hardwood create a 3.5mm hole. A clearance hole of 4mm should be drilled to accommodate the screw shank. Remember to set your power drill on a low torque setting to avoid breaking the screws. For fully fitted carpets the bracket sits on top of the rod and screw fixes it through the carpet.

Care and Maintenance

- We recommend using a damp cloth to keep the rods clean, any household cleaners used to clean the wood and paint work of the staircase should be applied to the cloth and not directly onto the surface of the stair, as over spray can cause a speckled tarnish on the rods. If any liquids are inadvertently spilt on the stair rods they should be cleaned immediately with a damp cloth and dried with a clean cloth.



- Available for runner carpets.
- Six finishes: Antique, Black, Brass, Satin Nickel, Chrome and Pewter.

Jubilee Prices

Option 1 For runners 27.5" (70cm) wide (stock size)	£4.67
Option 2 For runners 35" (89cm) wide (stock size)	£5.67
Option 3 For runners 47.25" (120cm) wide (stock size)	£6.67

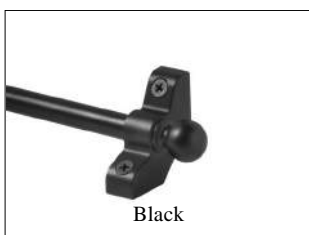



The Product

- The Jubilee range of stair rods are available for runner carpets only.
- The Jubilee range are available in three option sizes. See facing page for details
- Our Jubilee runner bracket clearance is 14mm

Option 1

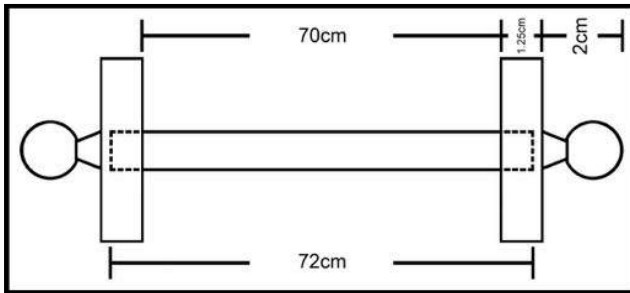

Option 2

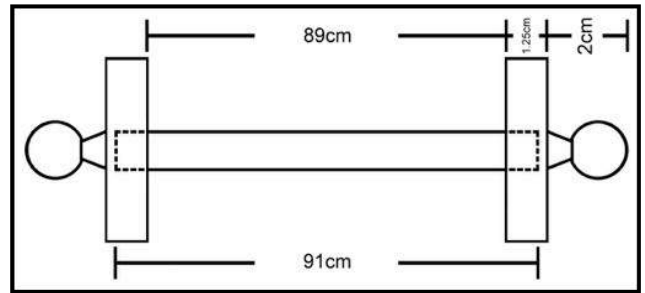

Option 3

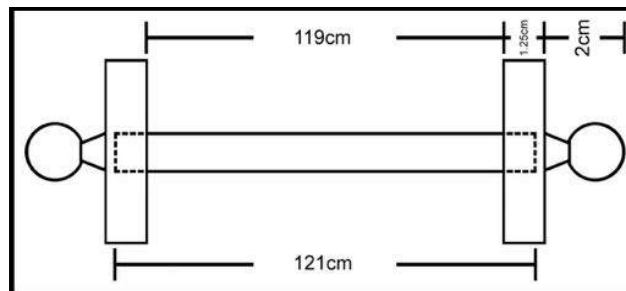

ANY QUESTIONS
Please call 01207 591176 For friendly expert advice.

• Jubilee Rod For Fully Fitted Carpet.

- The Jubilee comes as a three part set, two brackets with finials attached and a length of rod, this rod is easily cut down on site.

Fitting Rods To Stair.

- The brackets are supplied with number 6 screws and you must drill a pilot hole before fixing the brackets to the stair. For softwood create a 2.5mm pilot hole and for hardwood create a 3mm hole. Remember to set your power drill on a low torque setting to avoid breaking the screws.
- Fit one bracket to the tread and riser then cut the rod to size and put in place. Now fit the second bracket.

Cleaning

- We recommend using a damp cloth to keep the rods clean, any household cleaners used to clean the wood and paint work of the staircase should be applied to the cloth and not directly onto the surface of the stair, as over spray can cause a speckled tarnish on the rods. If any liquids are inadvertently spilt on the stair rods they should be cleaned immediately with a damp cloth and dried with a clean cloth.



- A stylish anodised stair rod.
- Available for runner and fully fitted carpets.
- Available in Black, Brass, Bronze, Chrome, Pewter, Satin Brass and Satin Nickel.
- The rods are 1/2" diameter.

Homepride Prices

	Runner Stock Length 36"	Fully Fitted Stock Length 30"	Side Fix Stock Length 36"
Standard price thereafter 8p/inch (2.5cm)	£8.35	£7.20	£7.20
25 rods and over	£6.26	£5.20	N/a

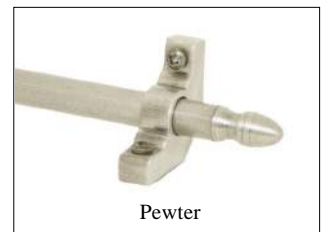



The Product

- The Homepride range of stair rods are available for either a runner carpet or fully fitted.
- The Homepride range are available in stock lengths, see below for measuring guidelines.
- The Homepride range stock lengths are shown on the facing page for details. They are easily cut down on site.

Homepride Rod For Fully Fitted Carpet.

- We recommend that you add 4 inches (10cm) to the width of your carpet and use this measurement to give you the tip to tip length of the stair rod. **NOTE: Tip to tip measurement includes the finials.**
- Our standard runner bracket for this range has a clearance of 13mm however if you have either a deep pile carpet or thin carpet please call for advice.

ANY QUESTIONS
Please call 01207 591176 For friendly expert advice.

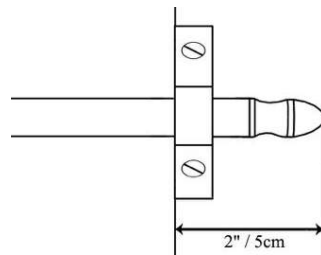

Homepride Rod For Fully Fitted Carpet.

- Depending on the width of the stair we recommend that you leave a 1 to 2 inch (2.5 to 5cm) gap between the stringboard and the tip of the rod at both sides of the staircase.

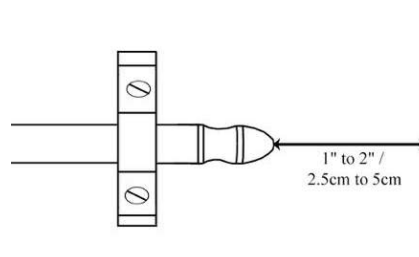

Fitting Rods To Stair.

- Both runner and fully fitted brackets are supplied with number 8 screws and you must drill a pilot hole before fixing the brackets to the stair. For softwood create a 3mm pilot hole and for hardwood create a 3.5mm hole. A clearance hole of 4mm should be drilled to accommodate the screw shank. The side fix brackets are supplied with a number 6 screw and need a 2.5mm pilot hole for soft wood and a 3mm for hard wood. Remember to set your power drill on a low torque setting to avoid breaking the screws. With the hinged bracket separated fit the bottom half to the stair and put the rod in place then re fit the top half of the bracket by sliding the two half together, finally close with the dome head screw. For fully fitted carpets the supplied bracket sits on top of the rod and screws fix it through the carpet.

Cleaning

- We recommend using a damp cloth to keep the rods clean, any household cleaners used to clean the wood and paint work of the staircase should be applied to the cloth and not directly onto the surface of the stair, as over spray can cause a speckled tarnish on the rods. If any liquids are inadvertently spilt on the stair rods they should be cleaned immediately with a damp cloth and dried with a clean cloth.

Easyrod Stair Rods



- Available for runner and fully fitted carpets.
- Four colours: Brass, bronze, chrome and black.
- The rods are 3/8" diameter.

Easyrod Prices

Stock size 30"(76cm) thereafter 8p per inch (2.5cm)	£3.67
25 rods and over	£3.20



Brass



Bronze



Chrome



Black

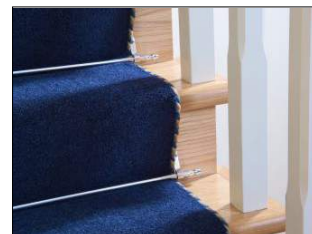
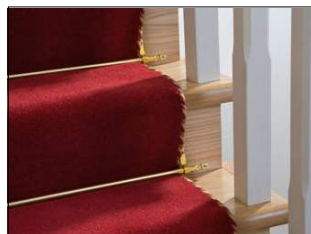
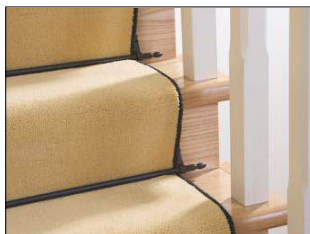



The Product

- The Easy Rod range of stair rods are available for either a runner carpet or fully fitted.
- The Easy Rod range are made to measure, see below for measuring guidelines.

Easy Rod Stair Rod For Carpet Runner.

- We recommend that you add 4 inches (10cm) to the width of your carpet and use this measurement to give you the tip to tip length of the stair rod.

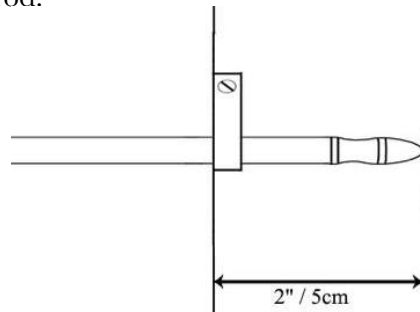

- Because of the universal nature of the Easy Rod bracket it can be used on both deep pile and thin carpets. When used on a deep pile carpet the screw thread will be visible when viewed from the side.

ANY QUESTIONS
Please call 01207 591176 For friendly expert advice.

Easy Rod Rod For Fully Fitted Carpet.

- Depending on the width of the stair we recommend that you leave a 1 to 2 inch (2.5 to 5cm) gap between the stringboard and the tip of the rod at both sides of the staircase.

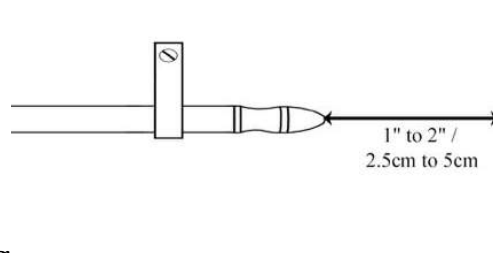

Prepare Brackets For fitting

- The brackets for runner carpets and fully fitted are the same and need no preparation.

Fitting Rods To Stair.

- The brackets are supplied with number 6 screws and you must drill a pilot hole before fixing the brackets to the stair. For softwood create a 2.5mm pilot hole and for hardwood create a 3mm hole. A clearance hole of 4mm should be drilled to accommodate the screw shank. Remember to set your power drill on a low torque setting to avoid breaking the screws. For fully fitted carpets the supplied bracket sits on top of the rod and screws fix it through the carpet.

Care and Maintenance

- We recommend using a damp cloth to keep the rods clean, any household cleaners used to clean the wood and paint work of the staircase should be applied to the cloth and not directly onto the surface of the stair, as over spray can cause a speckled tarnish on the rods. If any liquids are inadvertently spilt on the stair rods they should be cleaned immediately with a damp cloth and dried with a clean cloth.

Stargrip Stair Rods



- Available for runner and fully fitted carpets.
- Four colours: Brass, bronze, chrome and black.

Stargrip Price

Stock size 36" (91.5cm) thereafter £1.48 per 12" (30.5cm)

£5.23



Brass



Bronze



Chrome



Black





The Product

- The Stargrip range of stair rods are available only for fully fitted carpets.
- The Stargrip range is available in four finishes. See facing page for details.
- The Stargrip range are sold in stock lengths and are easily cut down on site. See facing page for details.

ANY QUESTIONS
Please call 01207 591176 For friendly expert advice.

Without Gripper

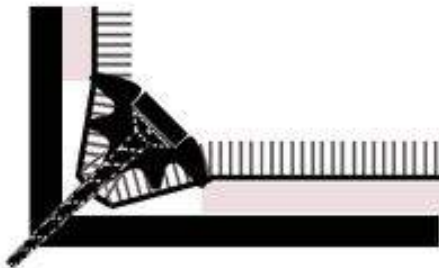

With Gripper

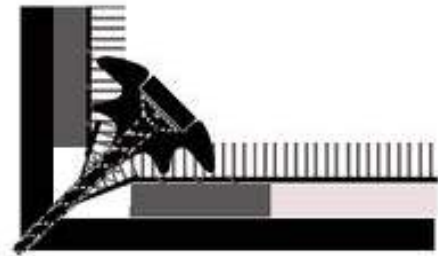

Fitting Rods To Stair

- Stargrip can be 'Retro Fitted' onto a stair carpet that has been fitted using gripper to give an appealing decorative look to the staircase.
- On a new installation the Stargrip can be used instead of gripper to fix the carpet to the stair. The action of screwing the Stargrip through the carpet stretches the carpet and holds it firmly in place.
- After fitting the screws are hidden by applying the pre-taped inlay in the recessed channel.
- Stargrip are supplied with number 6 screws and you must drill a pilot hole before fixing the brackets to the stair. For softwood create a 2.5mm pilot hole and for hardwood create a 3mm hole. A clearance hole of 4mm should be drilled to accommodate the screw shank. Remember to set your power drill on a low torque setting to avoid breaking the screws.

Care and Maintenance

- We recommend using a damp cloth to keep the rods clean, any household cleaners used to clean the wood and paint work of the staircase should be applied to the cloth and not directly onto the surface of the stair, as over spray can cause a speckled tarnish on the rods. If any liquids are inadvertently spilt on the stair rods they should be cleaned immediately with a damp cloth and dried with a clean cloth.

Victorian Stair Clips



- Available in Brass, Antique Brass, Chrome, Satin Nickel, Pewter, Satin Brass and Black.
- Sold in pairs.

Victorian Stair Clip Prices

Available in Brass, Antique Brass, Chrome, Satin Nickel, Pewter, Satin Brass and Black.

Per Pair

£7.95

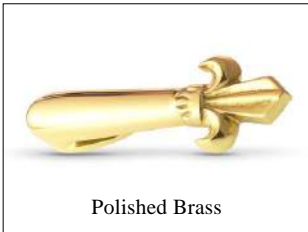

Polished Brass



Satin Brass



Antique Brass



Chrome



Satin Nickel



Black



Pewter





The Product

- The Victorian Stair Clip for runner carpets only.
- The Victorian Stair Clip Range are sold as a pair.

Prepare Hinge Brackets For fitting

- The Victorian Stair Clip fixing plate needs to be pivoted at 90 degrees to the main body of the clip. This gives access to the screw holes.



ANY QUESTIONS
Please call 01207 591176 For friendly expert advice.

Fitting Rods To Stair.

- Fitting the Victorian Stair Clip is easier if done before fitting the carpet.
- First mark the width of the carpet where the tread meets the riser, use this mark to line up the inner edge of the fixing plate with where the edge of the carpet will be.
- Next measure the height of the carpet and underlay, this will give you a guide to ensure you fit the Victorian Stair Clip level.
- Now line the bottom surface of the Clip with the carpet height mark and have the fixing plate perfectly level. Mark with a pencil around the fixing plate.
- Pivot the fixing plate and line it up with the pencil mark and mark the holes.
- You can now make a template using the hole positions and carpet width and height marks to give the position of the hole on the remaining stairs.
- Victorian Stair Clips are supplied with number 6 screws and you must drill a pilot hole before fixing the brackets to the stair. For softwood create a 2.5mm pilot hole and for hardwood create a 3mm hole. Remember to set your power drill on a low torque setting to avoid breaking the screws.

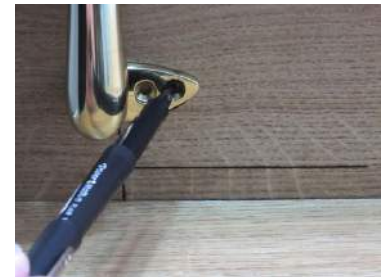

Care and Maintenance

- We recommend using a damp cloth to keep the rods clean, any household cleaners used to clean the wood and paint work of the staircase should be applied to the cloth and not directly onto the surface of the stair, as over spray can cause a speckled tarnish on the rods. If any liquids are inadvertently spilt on the stair rods they should be cleaned immediately with a damp cloth and dried with a clean cloth.



- Available in: Polished Brass, Antique Brass, Satin Brass, Chrome, Satin Nickel, Pewter and Black.
- Minimum order of 6 in any combination. **Available in smaller quantities with a £7.50 carriage charge.**

Skiffer Prices

75mm	£5.20 each
107mm	£5.74 each
134mm	£6.58 each





- Features a specially designed 19mm serrated stud to fix through even the thickest of carpets.
- Available in: Brass, Antique Brass, Chrome, Satin Nickel and Black/Pewter.

Easystud Prices

Available in Brass, Antique Brass,, Chrome, Satin Nickel, and Black/Pewter,

1 Jar (100 approx) *Available with a £7.50 carriage charge.*

£10.85

1 Jar (250 approx)

£27.12

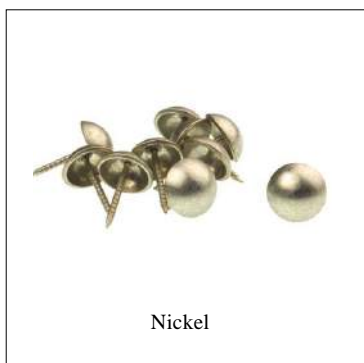
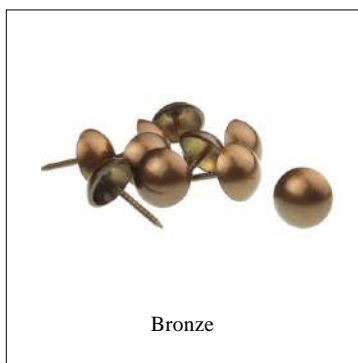



- Fixing your height differences
- Each shim is 36" (91.5cm) wide with an 8" (20cm) ramp.

Easyshim Prices

	6mm (nominal)	9mm (nominal)	12mm (nominal)	15mm (nominal)
1 pack (10 shims)	£31.92	£34.59	£39.95	£45.31
5 pack (50 shims)	£21.21	£23.88	£29.23	£34.58
10 pack (100 shims)	£19.07	£21.42	£26.24	£31.06

5 and 10 pack prices can be in any combination of shims e.g. 1 pack of 6mm, 1 pack of 9mm, 1 pack of 12mm, 1 pack of 15mm and 1 pack of side shims, or 5 packs of 9mm.

Easyshim Side Shim Prices

1 pack Side Shims	£28.92	£31.15	£36.85	£42.21
-------------------	--------	--------	--------	--------

Easyshim Starter Pack Price

Easy Shim Starter Pack contains the following: Easy Shims 2 x 6mm, 2 x 9mm, 2 x 12mm, Side Shims 4 x 6mm, 4 x 9mm, 4 x 12mm. This is sufficient for 6 door ways.	£40.74
--	--------

Height Difference Rough Guide

Height Difference (HD) rough guide for DoubleZ™ ⁹ using shims, chocks & underlay										
(HD)	Shim		Chock		Base		Gap		Nap	Equals (HD)
16mm	6mm	+	3mm	+	1mm	+	9mm	-	3mm	= 16mm
19mm	9mm	+	3mm	+	1mm	+	9mm	-	3mm	= 19mm
22mm	12mm	+	3mm	+	1mm	+	9mm	-	3mm	= 22mm
25mm	15mm	+	3mm	+	1mm	+	9mm	-	3mm	= 25mm



Product

- The Easyshim is the perfect way to raise the level of your carpet if you encounter a height difference.
- Used in a 'Combo' with our Easychocks to transition a height difference of up to 25mm.

Fitting

- The Easyshims can be either nailed or stuck down.
- Use the rough guide on the facing page to chose the correct 'Combo' for your installation.



ANY QUESTIONS
Please call 01207 591176 For friendly expert advice.

Easyshim

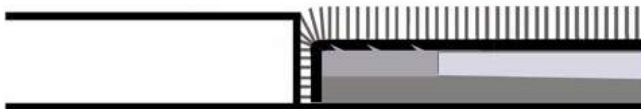

Easyshim & DoubleZ™9



Easyshim, DoubleZ™9
& Easychock



Easyshim & Lip

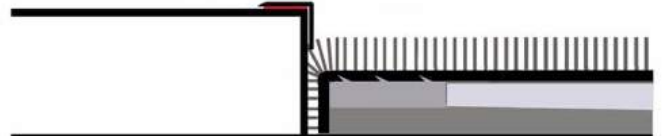



- A convenient 'Raised Base'.
- Can be stacked.
- Ideal when using deep underlay.

Easychocks & Easywedges Prices

A convenient 'Raised Base' for our DoubleZ™, Z Trim, Square and Single.

	1 Bucket	10 + Buckets
Easychock Bucket (approx 250)	£8.00	£7.11 each
Easywedge Bucket (approx 250)	£6.00	£5.33 each
Easychock Bucket (approx 1000)	£30.00	£28.00 each
Easywedge Bucket (approx 1000)	£22.00	£20.00 each

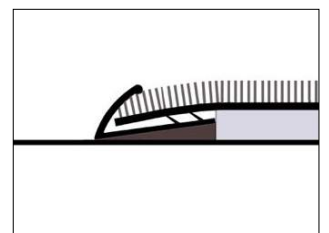
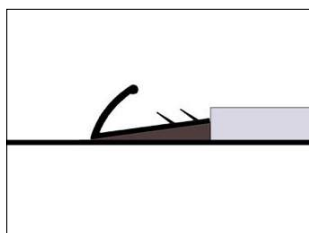
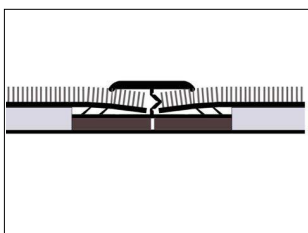
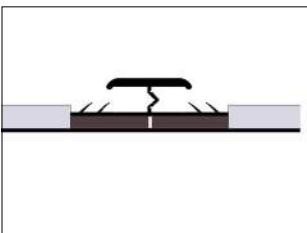
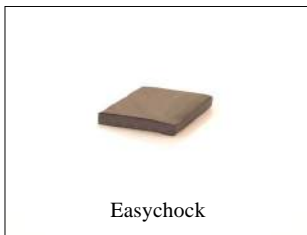



Product

- The Easychocks & Easywedges are a convenient 'Raised Base' for use with our DoubleZ™/ Zbar, Square and Single.
- The Easychocks & Easywedges are supplied with every order of DoubleZ™, Square and Single, but are also available to purchase in buckets of 250 and 1000.

Fitting

- The Easychocks can be used singularly or stacked to achieve the height required and are supplied in a standard height of 3mm. They should be placed at each end of the door bar and located at the fixing holes then nailed through. It is then easy to slip the remaining Easychocks in place at the remaining fixing points along the door bar.



- The Easywedges can only be used singularly to achieve the height required and are supplied in a standard height of 3mm, if you require heights above or below this to a maximum of 6mm please consider using our 'Dim Strips' on page 54. The Easywedges should be placed at each end of the door bar and located at the fixing holes then nailed through. It is then easy to slip the remaining Easychocks in place at the remaining fixing points along the door bar.



ANY QUESTIONS
Please call 01207 591176 For friendly expert advice.

DoubleZ™ 1 Chock



DoubleZ™ 2 Chocks



Zbar 1 Chock



Zbar 2 Chocks



Square 1 Chock



Square 2 Chocks

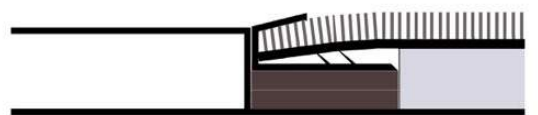

Single 1 Wedge



Single + Dim Strip





- The DoubleZ™9 is a Double Nap lock and Z Trim.
- Use Easychocks to raise the base if required.

DoubleZ™9 Prices

		Single Price		50 Price (Any Trims)	
Profile Type	Size	Standard	Specialised	Standard	Specialised
	90cm	£16.50	£23.83	£14.85	£20.85
	180cm	£33.00	£47.66	£29.70	£41.70
	270cm	£49.40	£71.49	£44.55	£62.55

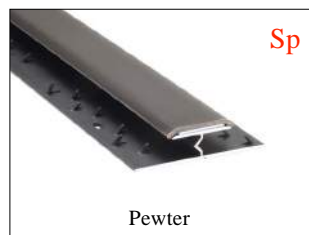

Carriage paid on 3 and over on this item. Less than 3 £7.50 carriage charge.



Product

- The Premier Trim DoubleZ™9 range of door bars are a high quality product for a high quality installation.
- The Premier Trim DoubleZ™9 range are available in three lengths: 90cm, 180cm and 270cm.

Fitting

- The Premier Trim DoubleZ™9 range can be used for a carpet to carpet and carpet to hard floor installations due to an ingenious design feature.
- To transform the DoubleZ™9 into a Z Bar simply score along the peel line on the back of the base plate with a Stanley Knife and peel away with a pair of pliers.



ANY QUESTIONS
Please call 01207 591176 For friendly expert advice.

- When used with thin underlays of 6mm and below the DoubleZ™9 can be fitted directly to the floor.
- Remember to ‘Nap’ down the DoubleZ™9 to give the carpet a firm grip on the pins.
- Be sure you have a 3mm or more gap between the underside of the top part of the Z Bar and the hard floor surface, this will allow you to ‘Nap’ down to secure the carpet on the pins.



- If you are using underlays of over 6mm or you have a high hard floor you can use Stairrods ‘Easychocks’ on page 33 to provide a convenient raised base for the DoubleZ™9 or Z Bar.
- Use individually or stack the ‘Easychocks’ to raise the base close to the level of the underlay and the top to at least 3mm above the hard floor. In a carpet to carpet situation this will allow the carpet to gain a better fix on the pins and with carpet to hard floor it will also raise the Z Bar sufficiently to allow a ‘Nap’ of 3mm or more to the floor surface.
- The ‘Easychocks’ should be placed at the fixing points and nailed through.



Care and Maintenance

- Satin Brass and Polished Brass Trims can be left to age (oxidise) for a natural finish. However to keep the brass like new these two finishes will need to be polished from time to time with a propriety brass polish. Ensure that you follow the instructions on the tin and protect your flooring during polishing.
- Satin Nickel, Chrome, and Brushed Chrome These finishes will need to be polished from time to time with a propriety metal polish. Ensure that you follow the instructions on the tin and protect your flooring during polishing.
- Pewter, Antique Bronze and Antique Brass If these finishes become contaminated the only option is to polish them with a propriety metal polish and allow them to age again naturally. Ensure that you follow the instructions on the tin and protect your flooring during polishing.



- The DoubleZ™4 is a Double Naplock and Z Trim.
- Use Easychecks to raise the base if required.

DoubleZ™4 Prices

		Single Price		50 Price (Any Trims)	
Profile Type	Size	Standard	Specialised	Standard	Specialised
	90cm	£15.99	£23.32	£14.39	£20.41
	180cm	£31.98	£46.44	£28.78	£40.82
	270cm	£47.97	£69.66	£43.17	£61.23

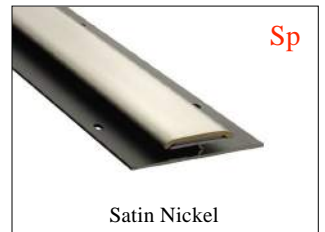
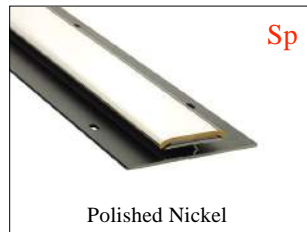
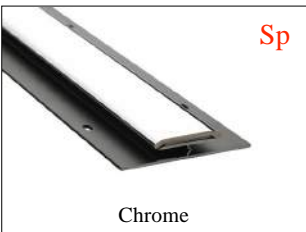

Carriage paid on 3 and over on this item. Less than 3 £7.50 carriage charge.



Product

- The Premier Trim DoubleZ™4 range of door bars are a high quality product for a high quality installation.
- The Premier Trim DoubleZ™4 range are available in three lengths: 90cm, 180cm and 270cm.

Fitting

- The Premier Trim DoubleZ™4 range can be used for a shallow pile carpet to carpet and shallow pile carpet to hard floor installations due to an ingenious design feature.
- To transform the DoubleZ™4 into a Z Bar simply score along the peel line on the back of the base plate with a Stanley Knife and peel away with a pair of pliers.



ANY QUESTIONS
Please call 01207 591176 For friendly expert advice.

- When used with thin underlays of 6mm and below the DoubleZ™4 can be fitted directly to the floor.
- Remember to 'Nap' down the DoubleZ™4 to give the carpet a firm grip.
- See some installation examples below.

Direct Stick



Floating LV/ Direct Stick



- If you are using underlays of over 6mm or you have a high hard floor you can use Stairrods 'Easychocks' on page 33 to provide a convenient raised base for the DoubleZ™4 or Z Bar.
- Use individually or stack the 'Easychocks' to raise the base.
- The 'Easychocks' should be placed at the fixing points and nailed through.

Double Stick



LV & Latex / Double Stick



Care and Maintenance

- Satin Brass and Polished Brass Trims can be left to age (oxidise) for a natural finish. However to keep the brass like new these two finishes will need to be polished from time to time with a propriety brass polish. Ensure that you follow the instructions on the tin and protect your flooring during polishing.
- Satin Nickel, Chrome, and Brushed Chrome These finishes will need to be polished from time to time with a propriety metal polish. Ensure that you follow the instructions on the tin and protect your flooring during polishing.
- Pewter, Antique Bronze and Antique Brass If these finishes become contaminated the only option is to polish them with a propriety metal polish and allow them to age again naturally. Ensure that you follow the instructions on the tin and protect your flooring during polishing.

Premier Trim Single 9



- An attractive carpet edging profile.
- Can be used with Easychocks to offer a Raised Base.

Single 9 Prices

Profile Type	Size	Single Price		50 Price (Any Trims)	
		Standard	Specialised	Standard	Specialised
	90cm	£12.75	£20.11	£11.48	£17.60
	180cm	£25.50	£40.22	£22.96	£35.20
	270cm	£38.25	£60.33	£34.44	£52.80

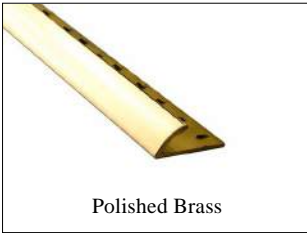

Carriage paid on 3 and over on this item. Less than 3 £7.50 carriage charge.



Product

- The Premier Trim Single9 range of door bars are a high quality product for a high quality installation.
- The Premier Trim Single9 range are available in three lengths: 90cm, 180cm and 270cm.

Fitting

- The Premier Trim Single9 range are for use as a carpet edge.

ANY QUESTIONS
Please call 01207 591176 For friendly expert advice.

- When used with thin underlays of 6mm and below the Premier Trim Single9 can be fitted directly to the floor.
- Remember to 'Nap' down the Premier Trim Single9 to give the carpet a firm grip on the pins.



- If you are using underlays of over 6mm or you have a high hard floor you can use Stairrods 'Easywedges' on page 33 for a 3mm raised base, or 'Dimstrips' on page 54 for raised base up to 6mm.
- Use the 'Easywedges' or 'Dimstrips' to raise the base close to the level of the underlay and allow the carpet to gain a better fix on the pins.
- The 'Easywedges' should be placed at the fixing points and nailed through.



Care and Maintenance

- Satin Brass and Polished Brass Trims can be left to age (oxidise) for a natural finish. However to keep the brass like new these two finishes will need to be polished from time to time with a propriety brass polish. Ensure that you follow the instructions on the tin and protect your flooring during polishing.
- Satin Nickel, Chrome, and Brushed Chrome These finishes will need to be polished from time to time with a propriety metal polish. Ensure that you follow the instructions on the tin and protect your flooring during polishing.
- Pewter, Antique Bronze and Antique Brass If these finishes become contaminated the only option is to polish them with a propriety metal polish and allow them to age again naturally. Ensure that you follow the instructions on the tin and protect your flooring during polishing.

Premier Trim Single 4



- An attractive carpet edging profile.
- To be used with thin stick down carpets where napping down a 9mm Single may prove difficult.

Single 4 Prices

Profile Type	Size	Single Price		50 Price (Any Trims)	
		Standard	Specialised	Standard	Specialised
	90cm	£12.24	£19.60	£11.02	£17.15
	180cm	£24.48	£39.20	£22.04	£34.30
	270cm	£36.72	£58.80	£33.06	£51.45

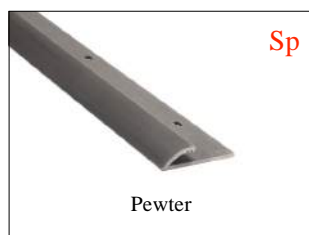
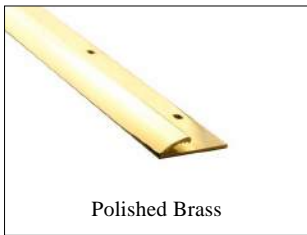

Carriage paid on 3 and over on this item. Less than 3 £7.50 carriage charge.



Product

- The Premier Trim Single4 range of door bars are a high quality product for a high quality installation.
- The Premier Trim Single4 range are available in three lengths: 90cm, 180cm and 270cm.

Fitting

- The Premier Trim Single4 range are for use as a carpet edge when fitting thin stick down carpet, giving a low profile trim.

ANY QUESTIONS
Please call 01207 591176 For friendly expert advice.

- Remember to 'Nap' down the Premier Trim Single4 to give the carpet a firm grip on the pins.

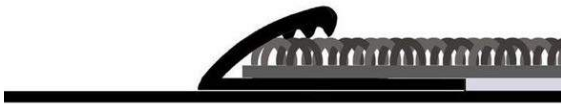

- If you are using stick down underlays you can use Stairrods 'Easywedges' on page 33 or 'Dimstrips' on page 54 for a raised base up to level of the underlay.
- Use the 'Easywedges' or 'Dimstrips' to raise the base close to the level of the underlay to allow a smooth transition on to the trim.
- The 'Easywedges' should be placed at the fixing points and nailed through.



Care and Maintenance

- Satin Brass and Polished Brass Trims can be left to age (oxidise) for a natural finish. However to keep the brass like new these two finishes will need to be polished from time to time with a propriety brass polish. Ensure that you follow the instructions on the tin and protect your flooring during polishing.
- Satin Nickel, Chrome, and Brushed Chrome These finishes will need to be polished from time to time with a propriety metal polish. Ensure that you follow the instructions on the tin and protect your flooring during polishing.
- Pewter, Antique Bronze and Antique Brass If these finishes become contaminated the only option is to polish them with a propriety metal polish and allow them to age again naturally. Ensure that you follow the instructions on the tin and protect your flooring during polishing.

Premier Trim Square



- A versatile edging profile.
- Can be used for a number of differing installations.
- For butting up to tiles, door surrounds and mat wells.

Square Prices

Profile Type	Size	Single Price		50 Price (Any Trims)	
		Standard	Specialised	Standard	Specialised
	90cm	£14.25	£21.61	£12.83	£18.91
	180cm	£28.50	£43.22	£25.66	£37.82
	270cm	£42.75	£64.83	£38.49	£56.73

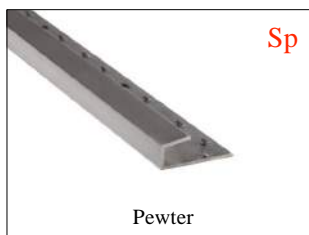
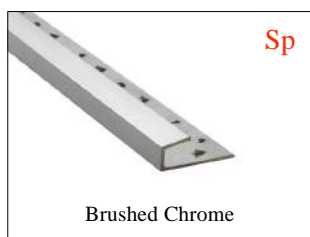
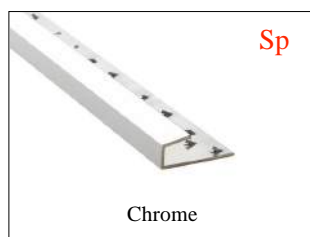
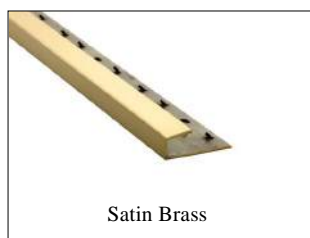

Carriage paid on 3 and over on this item. Less than 3 £7.50 carriage charge.



Product

- The Premier Trim Square range of door bars are a high quality product for a high quality installation.
- The Premier Trim Square range are available in three lengths: 90cm, 180cm and 270cm.

Fitting

- The Premier Trim Square range can be used for butting up to tiles, door surrounds and mat wells.



- When used with thin underlays of 6mm and below the Premier Trim Square can be fitted directly to the floor.
- Remember to 'Nap' down the Premier Trim Square to give the carpet a firm grip on the pins.



ANY QUESTIONS
Please call 01207 591176 For friendly expert advice.

- If you are using underlays of over 6mm or you have a high hard floor you can use Stairrods 'Easychocks' on page 33 to provide a convenient raised base for the Premier Trim Square.
- Use individually or stack the 'Easychocks' to raise the base close to the level of the underlay and the top of the hard floor.
- The 'Easychocks' should be placed at the fixing points and nailed through.

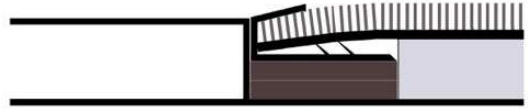

Care and Maintenance

- Satin Brass and Polished Brass Trims can be left to age (oxidise) for a natural finish. However to keep the brass like new these two finishes will need to be polished from time to time with a propriety brass polish. Ensure that you follow the instructions on the tin and protect your flooring during polishing.
- Satin Nickel, Chrome, and Brushed Chrome These finishes will need to be polished from time to time with a propriety metal polish. Ensure that you follow the instructions on the tin and protect your flooring during polishing.
- Pewter, Antique Bronze and Antique Brass If these finishes become contaminated the only option is to polish them with a propriety metal polish and allow them to age again naturally. Ensure that you follow the instructions on the tin and protect your flooring during polishing.



- Posh now available in specialised finishes (plain inlay only).
- New Posh 30 for LVT, use as a cover and vinyl edge up to 6mm.
- Beware of under floor heating

Posh 30 Prices

Profile Type	Size	Single Price		50 Price (Any Trims)	
		Standard	Specialised	Standard	Specialised
	90cm	£14.95	£22.31	£13.46	£20.08
	180cm	£29.90	£44.62	£26.92	£40.16
	270cm	£44.85	£66.93	£40.38	£60.24

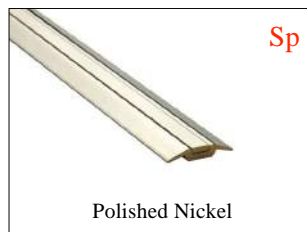
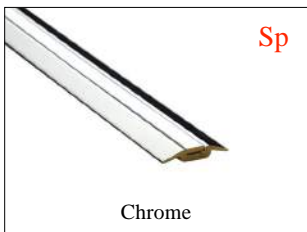
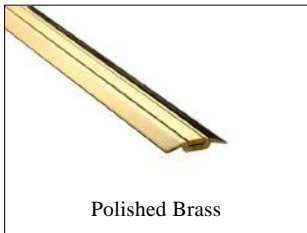

Carriage paid on 3 and over on this item. Less than 3 £7.50 carriage charge.



Product

- The Posh 30 range of Solid Brass door bars are a high quality product for a high quality installation.
- The Posh 30 range are available in three lengths: 90cm, 180cm, 270cm and in nine colours, see facing page.

ANY QUESTIONS
Please call 01207 591176 For friendly expert advice.

Fitting

- The Posh 30 range can be used for a thin stick down carpet to carpet, thin stick down carpet to vinyl and vinyl to vinyl installations.
- The Posh 30 is screw down product and the screw heads are then hidden using the stick down inlay.
- When fitting make sure the Posh 30 is screwed down firm enough so as not to allow the screws to lift and interfere with the inlay.
- When using on thin stick down carpet to hard floor fit the Posh 30 so that the carpet edge is in line with the under side edge of the inlay channel and screw down making sure the Posh 30 is screwed down firm enough so as not to allow the screws to lift and interfere with the inlay.



- When using on hard floor to hard floor ensure a gap of 12mm between the surfaces to accommodate the underside of the fitting channel, again, screw down firmly to prevent the screws from lifting the inlay from its channel.



- When using on hard floor to hard floor with a height difference the Posh 30 will accommodate up to a 6mm edge, again screw down firmly to prevent the screws from lifting the inlay from its channel.



Care and Maintenance

- Satin Brass and Polished Brass Trims can be left to age (oxidise) for a natural finish. However to keep the brass like new these two finishes will need to be polished from time to time with a propriety brass polish. Ensure that you follow the instructions on the tin and protect your flooring during polishing.
- Satin Nickel, Chrome, and Brushed Chrome These finishes will need to be polished from time to time with a propriety metal polish. Ensure that you follow the instructions on the tin and protect your flooring during polishing.
- Pewter, Antique Bronze and Antique Brass If these finishes become contaminated the only option is to polish them with a propriety metal polish and allow them to age again naturally. Ensure that you follow the instructions on the tin and protect your flooring during polishing.



- Posh now available in specialised finishes (plain inlay only).
- Posh 38 for LVT, carpet and hard floors.
- Beware of under floor heating

Posh 38 Prices

Profile Type	Size	Single Price		50 Price (Any Trims)	
		Standard	Specialised	Standard	Specialised
	90cm	£16.48	£23.84	£14.83	£21.46
	180cm	£32.96	£47.68	£29.66	£42.91
	270cm	£49.44	£71.52	£44.50	£64.37

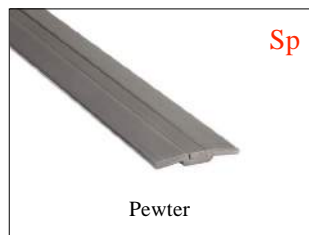
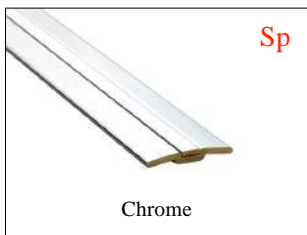

Carriage paid on 3 and over on this item. Less than 3 £7.50 carriage charge.



Product

- The Posh 38 range of Solid Brass door bars are a high quality product for a high quality installation.
- The Posh 38 range are available in three lengths: 90cm, 180cm, 270cm and in nine colours, see facing page.

ANY QUESTIONS
Please call 01207 591176 For friendly expert advice.

Fitting

- The Posh 38 range can be used for a carpet to carpet, carpet to hard floor and hard floor to hard floor installations.
- The Posh 38 is screw down product and the screw heads are then hidden using the stick down inlay.
- When using on a carpet to carpet installation you must still use gripper and fit the Posh 38 over the gripper to give the carpet a good grip making sure the Posh 38 is screwed down firm enough so as not to allow the screws to lift and interfere with the inlay.



- When using on carpet to hard floor fit the Posh 38 over the gripper on the carpet side and rest the other edge on the hard floor and screw down making sure the Posh 38 is screwed down firm enough so as not to allow the screws to lift and interfere with the inlay.



- When using on hard floor to hard floor ensure a gap of 12mm between the surfaces to accommodate the underside of the fitting channel, again, screw down firmly to prevent the screws from lifting the inlay from its channel.



- When using on hard floor to hard floor with a height difference the Posh 38 will accommodate up to a 6mm edge, again screw down firmly to prevent the screws from lifting the inlay from its channel.



Care and Maintenance

- Satin Brass and Polished Brass Trims can be left to age (oxidise) for a natural finish. However to keep the brass like new these two finishes will need to be polished from time to time with a propriety brass polish. Ensure that you follow the instructions on the tin and protect your flooring during polishing.
- Satin Nickel, Chrome, and Brushed Chrome These finishes will need to be polished from time to time with a propriety metal polish. Ensure that you follow the instructions on the tin and protect your flooring during polishing.
- Pewter, Antique Bronze and Antique Brass If these finishes become contaminated the only option is to polish them with a propriety metal polish and allow them to age again naturally. Ensure that you follow the instructions on the tin and protect your flooring during polishing.

Premier Trim Posh 55



- Posh now available in specialised finishes (plain inlay only).
- Posh 55 for LVT, deep pile carpet and hard floors.
- Beware of under floor heating

Posh 55 Prices

Profile Type	Size	Single Price		50 Price (Any Trims)	
		Standard	Specialised	Standard	Specialised
	90cm	£21.47	£28.83	£19.32	£25.95
	180cm	£42.94	£57.66	£38.65	£51.89
	270cm	£64.41	£86.49	£57.97	£77.84

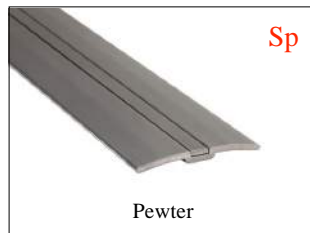
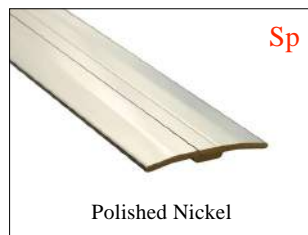
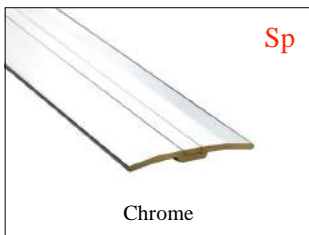

Carriage paid on 3 and over on this item. Less than 3 £7.50 carriage charge.



Product

- The Posh 55 range of Solid Brass door bars are a high quality product for a high quality installation.
- The Posh 55 range are available in three lengths: 90cm, 180cm, 270cm and in nine colours, see facing page.

Fitting

- The Posh 55 range can be used for a carpet to carpet, carpet to hard floor and hard floor to hard floor installations.
- The Posh 55 is screw down product and the screw heads are then hidden using the stick down inlay.

ANY QUESTIONS
Please call 01207 591176 For friendly expert advice.

- When using on a carpet to carpet installation you must still use gripper and fit the Posh 55 over the gripper to give the carpet a good grip making sure the Posh 55 is screwed down firm enough so as not to allow the screws to lift and interfere with the inlay.

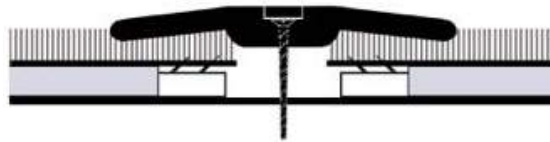

- When using on carpet to hard floor fit the Posh 55 over the gripper on the carpet side and rest the other edge on the hard floor and screw down making sure the Posh 55 is screwed down firm enough so as not to allow the screws to lift and interfere with the inlay.



- When using on hard floor to hard floor ensure a gap of 12mm between the surfaces to accommodate the underside of the fitting channel, again, screw down firmly to prevent the screws from lifting the inlay from its channel.



- When using on hard floor to hard floor with a height difference the Posh 55 will accommodate up to a 8mm edge, again screw down firmly to prevent the screws from lifting the inlay from its channel.



Care and Maintenance

- Satin Brass and Polished Brass Trims can be left to age (oxidise) for a natural finish. However to keep the brass like new these two finishes will need to be polished from time to time with a propriety brass polish. Ensure that you follow the instructions on the tin and protect your flooring during polishing.
- Satin Nickel, Chrome, and Brushed Chrome These finishes will need to be polished from time to time with a propriety metal polish. Ensure that you follow the instructions on the tin and protect your flooring during polishing.
- Pewter, Antique Bronze and Antique Brass If these finishes become contaminated the only option is to polish them with a propriety metal polish and allow them to age again naturally. Ensure that you follow the instructions on the tin and protect your flooring during polishing.



- The Premier Cover is a screw down product for almost every transition.
- A truly universal product.
- When fitted the fixing screws remain visible.
- Beware of under floor heating.

Cover Prices

Profile Type	Size	Single Price		50 Price (Any Trims)	
		Standard	Specialised	Standard	Specialised
	90cm	£14.50	£21.86	£13.05	£19.13
	180cm	£29.00	£43.72	£26.10	£38.26
	270cm	£43.50	£65.58	£39.15	£57.39

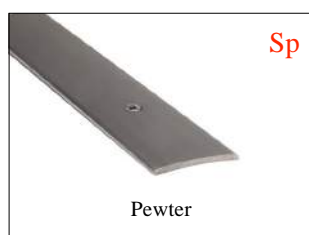
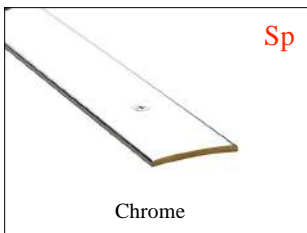
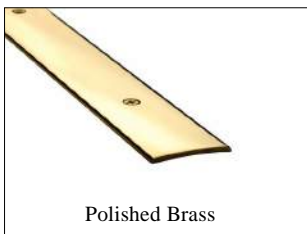

Carriage paid on 3 and over on this item. Less than 3 £7.50 carriage charge.



Product

- The Premier Trim Cover range of door bars are a high quality product for a high quality installation.
- The Premier Trim Cover range are available in three lengths: 90cm, 180cm and 270cm.

Fitting

- The Premier Trim Cover range is a universal trim that can be used for a carpet to carpet, carpet to hard floor and between two hard floors.
- The Premier Trim Cover is a screw down trim with the screws remaining visible after fitting.

ANY QUESTIONS
Please call 01207 591176 For friendly expert advice.



Care and Maintenance

- Satin Brass and Polished Brass Trims can be left to age (oxidise) for a natural finish. However to keep the brass like new these two finishes will need to be polished from time to time with a propriety brass polish. Ensure that you follow the instructions on the tin and protect your flooring during polishing.
- Satin Nickel, Chrome, and Brushed Chrome These finishes will need to be polished from time to time with a propriety metal polish. Ensure that you follow the instructions on the tin and protect your flooring during polishing.
- Pewter, Antique Bronze and Antique Brass If these finishes become contaminated the only option is to polish them with a propriety metal polish and allow them to age again naturally. Ensure that you follow the instructions on the tin and protect your flooring during polishing.



- The Premier Euro Cover is the perfect solution for installations using underfloor heating.
- When used with our dim strips the Euro Cover will accommodate a height difference of up to 6mm.
- Only suitable for 'Non Porous' surfaces.

30mm Euro Cover Prices (non floating)

Profile Type	Size	Single Price		50 Price (Any Trims)	
		Standard	Specialised	Standard	Specialised
	90cm	£10.69	£15.02	£9.62	£13.52
	180cm	£21.38	£30.04	£19.24	£27.04
	270cm	£32.07	£45.06	£28.86	£40.55

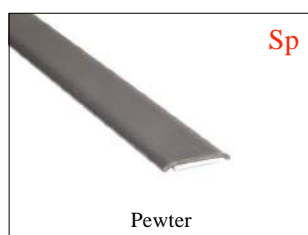
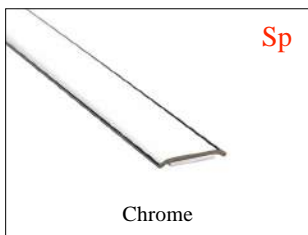
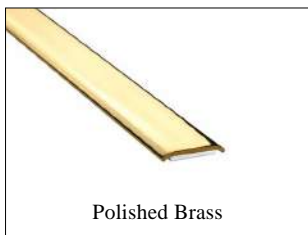

Carriage paid on 3 and over on this item. Less than 3 £7.50 carriage charge.



Technical



Product

- The 30mm Euro cover & Dim Strips are used for a 1mm to 6mm edge.
- The 30mm Euro cover is available in three lengths: 90cm, 180cm and 270cm.
- The Dim Strip is available in 90cm lengths and in six heights: 1mm, 2mm, 3mm, 4mm, 5mm and 6mm.
- The 30mm Euro Cover is ideally suited to areas where under floor heating has been installed as it is a ‘Stick Down’ product.
- The 30mm Euro Cover **cannot** be used for installations that require expansion. For this situation see our ‘Floating Euro Cover’ on page 55 and our Two Way Ramp on pages 57 & 59.

ANY QUESTIONS
Please call 01207 591176 For friendly expert advice.

Fitting

- On a level installation The 30mm Euro Cover can be fitted directly over the flooring joint making sure all surfaces are clean and free from dust and grease.
- Where the installation produces an edge, first assess the height and choose the correct dim strip. Stick the dim strip to the lower floor surface using either double sided tape or a flooring adhesive.
- Peel off the packing from the double sided tape applied to the 30mm Euro Cover and making sure the dim strip surface is free of dust and grease, stick down to the dim strip.

Dim Strip Prices

Dim Strip 1mm 90cm length	£0.65 each
Dim Strip 2mm 90cm length	£0.70 each
Dim Strip 3mm 90cm length	£0.80 each
Dim Strip 4mm 90cm length	£0.90 each
Dim Strip 5mm 90cm length	£1.01 each
Dim Strip 6mm 90cm length	£1.10 each



3mm Edge



3mm Dim Strip



30mm Euro Cover fitted with 3mm Dim Strip

Care and Maintenance

- Satin Brass and Polished Brass Trims can be left to age (oxidise) for a natural finish. However to keep the brass like new these two finishes will need to be polished from time to time with a propriety brass polish. Ensure that you follow the instructions on the tin and protect your flooring during polishing.
- Satin Nickel, Chrome, and Brushed Chrome These finishes will need to be polished from time to time with a propriety metal polish. Ensure that you follow the instructions on the tin and protect your flooring during polishing.
- Pewter, Antique Bronze and Antique Brass If these finishes become contaminated the only option is to polish them with a propriety metal polish and allow them to age again naturally. Ensure that you follow the instructions on the tin and protect your flooring during polishing.



- Use on hard 'Non Porous' floors that are required to float.
- Ideal for floors which are level or with a 1mm or 2mm height difference.
- Nine finishes: Antique Brass, Antique Bronze, Brass, Brushed Chrome, Chrome, Pewter, Polished Nickel, Satin Brass and Satin Nickel.

Floating Euro Cover Prices

Profile Type	Size	Single Price		50 Price (Any Trims)	
		Standard	Specialised	Standard	Specialised
20mm Floating Euro Cover 	90cm	£8.02	£11.52	£7.22	£10.37
	180cm	£16.04	£23.04	£14.44	£20.74
	270cm	£24.06	£34.56	£21.66	£31.11
Floating Vinyl Edge 1mm 	90cm	£8.58	£12.08	£7.72	£10.87
	180cm	£17.16	£24.16	£15.44	£21.74
	270cm	£25.74	£36.24	£23.16	£32.61
Floating Vinyl Edge 2mm 	90cm	£9.10	£12.60	£8.19	£11.34
	180cm	£18.20	£25.20	£16.38	£22.68
	270cm	£27.30	£37.80	£24.57	£34.02

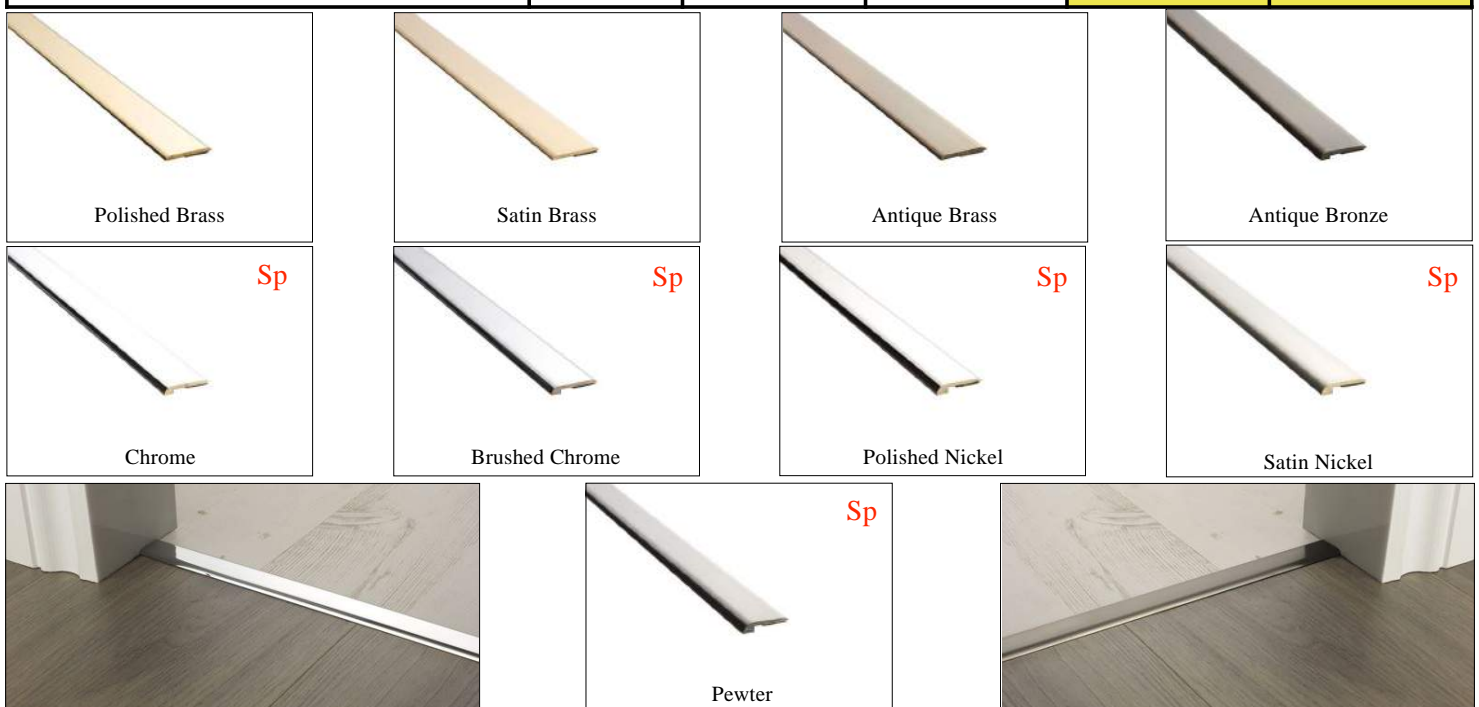

Carriage paid on 5 and over on this item. Less than 5 £7.50 carriage charge.



Product

- The Premier 20mm Floating Euro Cover & Vinyl Edge range of door bars are a high quality product for a high quality installation.
- The Premier 20mm Floating Euro Cover & Vinyl Edge range are available in three lengths: 90cm, 180cm and 270cm.

Fitting

- The Premier 20mm Floating Euro Cover & Vinyl Edge range are for use on vinyl to vinyl installations and due to an ingenious design feature can be used on floating or stick down installations which are either level or with a height differences of 1mm and 2mm.

ANY QUESTIONS
Please call 01207 591176 For friendly expert advice.

Stick Down / Floating Installations

- On a level installation where one surface is stick down and the other is floating, or both surfaces float, use the 20mm Floating Euro Cover. The 20mm Floating Euro Cover can be stuck to either the fixed or floating surface but make sure you allow enough room for the maximum expansion. For floating floors remove the backing off one piece of the pre applied tape and stick down leaving the backing on the other piece to give a cushion. For fixed floors remove the backing off both pieces of the pre applied tape and stick down.
- **NOTE: For expansion information consult the flooring manufacturers specifications.**



Stick Down / Floating Installations 1mm or 2mm Height Difference.

- On an installation with a 1mm or 2mm height difference where one surface is stick down and the other is floating, or both surfaces float, use the Floating Vinyl Edge 1mm or 2mm. Peel off the backing from the pre applied double sided tape and stick to the higher surface making sure that the surfaces are free from dust and grease. Allow enough cover for the maximum expansion.
- **NOTE: For expansion information consult the flooring manufacturers specifications.**

Get your Drop Checker



Care and Maintenance

Ask your Stairrods UK Sales Representative.

- Satin Brass and Polished Brass Trims can be left to age (oxidise) for a natural finish. However to keep the brass like new these two finishes will need to be polished from time to time with a propriety brass polish. Ensure that you follow the instructions on the tin and protect your flooring during polishing.
- Satin Nickel, Chrome, and Brushed Chrome These finishes will need to be polished from time to time with a propriety metal polish. Ensure that you follow the instructions on the tin and protect your flooring during polishing.
- Pewter, Antique Bronze and Antique Brass If these finishes become contaminated the only option is to polish them with a propriety metal polish and allow them to age again naturally. Ensure that you follow the instructions on the tin and protect your flooring during polishing.



- Use on hard 'Non Porous' floors.
- Ideal for floors which are fitted on under floor heating.
- Covers height differences of between 2mm and 5mm.
- Nine finishes: Antique Brass, Antique Bronze, Brass, Brushed Chrome, Chrome, Pewter, Polished Nickel, Satin Brass and Satin Nickel.

Two-Way Ramp 2-3mm & 4-5mm Prices

Profile Type	Size	Single Price		50 Price (Any Trims)	
		Standard	Specialised	Standard	Specialised
Two-Way Ramp 2-3mm 	90cm	£9.49	£12.99	£8.51	£11.69
	180cm	£18.98	£25.98	£17.02	£23.38
	270cm	£28.47	£38.97	£25.53	£35.07
Two-Way Ramp 4-5mm 	90cm	£10.12	£13.62	£9.11	£12.26
	180cm	£20.24	£27.24	£18.22	£24.52
	270cm	£30.36	£40.86	£27.33	£36.78

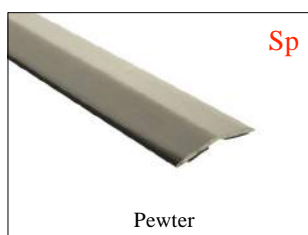
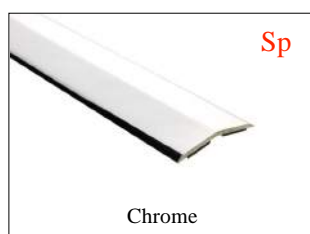
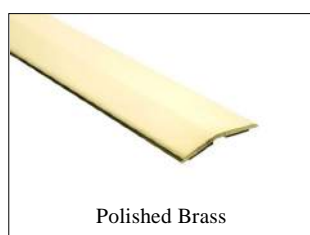

Carriage paid on 5 and over on this item. Less than 5 £7.50 carriage charge.



Product

- The Premier Two Way Ramp range of door bars are a high quality product for a high quality installation.
- The Premier Two Way Ramp range are available in three lengths: 90cm, 180cm and 270cm.

Fitting

- The Premier Two Way Ramp range are for use on 'Non Porous' installations which have a height differences and each product covers two different heights by simply turning the Two Way Cover around.

ANY QUESTIONS
Please call 01207 591176 For friendly expert advice.

Stick Down or Floating Installations

On an installation where one surface is stick down and the other is floating, or both surfaces float, use the Two Way Ramp. Can also be used in a 'No Float' situation.

- **NOTE: For expansion information consult the flooring manufacturers specifications.**

Stick down the wide surface for a 2mm lift.



Stick down the narrow surface for a 3mm lift.



Get your Drop Checker



Stick down the wide surface for a 4mm lift.



Ask your Stairrods UK Sales Representative.

Stick down the narrow surface for a 5mm lift.



Care and Maintenance

- Satin Brass and Polished Brass Trims can be left to age (oxidise) for a natural finish. However to keep the brass like new these two finishes will need to be polished from time to time with a propriety brass polish. Ensure that you follow the instructions on the tin and protect your flooring during polishing.
- Satin Nickel, Chrome, and Brushed Chrome These finishes will need to be polished from time to time with a propriety metal polish. Ensure that you follow the instructions on the tin and protect your flooring during polishing.
- Pewter, Antique Bronze and Antique Brass If these finishes become contaminated the only option is to polish them with a propriety metal polish and allow them to age again naturally. Ensure that you follow the instructions on the tin and protect your flooring during polishing.

Premier Trim Two-Way Ramp 6-7mm & 8-9mm 59



- Use on hard 'Non Porous' floors.
- Ideal for floors which are fitted over under floor heating.
- Covers height differences of between 6mm and 9mm.
- Nine finishes: Antique Brass, Antique Bronze, Brass, Brushed Chrome, Chrome, Pewter, Polished Nickel, Satin Brass and Satin Nickel.

Two-Way Ramp 6-7mm & 8-9mm Prices

Profile Type	Size	Single Price		50 Price (Any Trims)	
		Standard	Specialised	Standard	Specialised
Two-Way Ramp 6-7mm 	90cm	£11.03	£14.53	£9.93	£13.08
	180cm	£22.06	£29.06	£19.86	£26.16
	270cm	£33.09	£43.59	£29.79	£39.24
Two-Way Ramp 8-9mm 	90cm	£12.22	£15.72	£11.00	£14.15
	180cm	£24.44	£31.44	£22.00	£28.30
	270cm	£36.66	£47.16	£33.00	£42.45

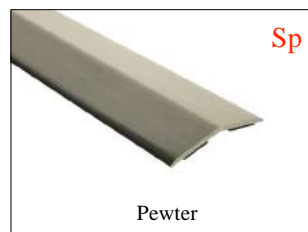
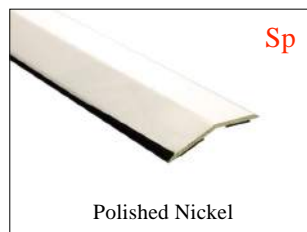
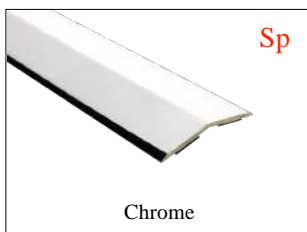

Carriage paid on 5 and over on this item. Less than 5 £7.50 carriage charge.



Technical



60

Product

- The Premier Two Way Ramp range of door bars are a high quality product for a high quality installation.
- The Premier Two Way Ramp range are available in three lengths: 90cm, 180cm and 270cm.

Fitting

- The Premier Two Way Ramp range are for use on 'Non Porous' installations which have a height difference and each product covers two different heights by simply turning the Two Way Cover around.

ANY QUESTIONS
Please call 01207 591176 For friendly expert advice.

Stick Down or Floating Installations

- On an installation where one surface is stick down and the other is floating, or both surfaces float, use the Two Way Ramp. Can also be used in a 'No Float' situation.
- **NOTE: For expansion information consult the flooring manufacturers specifications.**

Stick down the
wide surface for a
6mm lift.



Stick down the
narrow surface for
a 7mm lift.



Get your Drop Checker



Stick down the
wide surface for a
8mm lift.



Ask your Stairrods UK Sales Representative.

Stick down the
narrow surface for
a 9mm lift.



Care and Maintenance

- Satin Brass and Polished Brass Trims can be left to age (oxidise) for a natural finish. However to keep the brass like new these two finishes will need to be polished from time to time with a propriety brass polish. Ensure that you follow the instructions on the tin and protect your flooring during polishing.
- Satin Nickel, Chrome, and Brushed Chrome These finishes will need to be polished from time to time with a propriety metal polish. Ensure that you follow the instructions on the tin and protect your flooring during polishing.
- Pewter, Antique Bronze and Antique Brass If these finishes become contaminated the only option is to polish them with a propriety metal polish and allow them to age again naturally. Ensure that you follow the instructions on the tin and protect your flooring during polishing.



- Use on hard 'Non Porous' floors.
- Ideal for floors which are fitted over under floor heating.
- Covers height differences of 10mm and 12mm.
- Nine finishes: Antique Brass, Antique Bronze, Brass, Brushed Chrome, Chrome, Pewter, Polished Nickel, Satin Brass and Satin Nickel.

Ramp 10mm & 12mm Prices

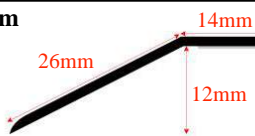
Profile Type	Size	Single Price		50 Price (Any Trims)	
		Standard	Specialised	Standard	Specialised
Ramp 10mm 	90cm	£10.40	£13.90	£9.36	£12.51
	180cm	£20.80	£27.80	£18.72	£25.02
	270cm	£31.20	£41.70	£28.08	£37.53
Ramp 12mm 	90cm	£11.06	£14.56	£9.95	£13.10
	180cm	£22.12	£29.12	£19.90	£26.20
	270cm	£33.18	£43.68	£29.85	£39.30

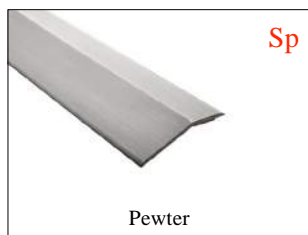
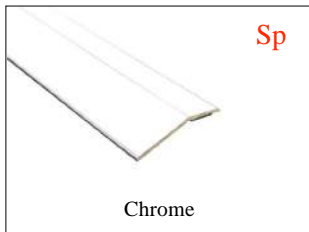

Carriage paid on 5 and over on this item. Less than 5 £7.50 carriage charge.



Technical



62

Product

- The Premier Ramp range of door bars are a high quality product for a high quality installation.
- The Premier Ramp range are available in three lengths: 90cm, 180cm and 270cm.

Fitting

- The Premier Ramp range is for use on 'Non Porous' hard floor to hard floor installations where floating is required and /or under floor heating is an issue. Can also be used in a 'No Float' situation.

ANY QUESTIONS
Please call 01207 591176 For friendly expert advice.

- For use when encountering height differences of 10mm, 12mm.
- Simply clean the floor surface and stick down.

NOTE: For expansion information consult the flooring manufacturers specifications.



10mm Ramp

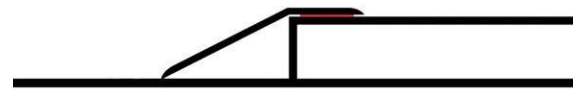

12mm Ramp

Get your Drop Checker



Ask your Stairrods UK Sales Representative.

Care and Maintenance

- Satin Brass and Polished Brass Trims can be left to age (oxidise) for a natural finish. However to keep the brass like new these two finishes will need to be polished from time to time with a propriety brass polish. Ensure that you follow the instructions on the tin and protect your flooring during polishing.
- Satin Nickel, Chrome, and Brushed Chrome These finishes will need to be polished from time to time with a propriety metal polish. Ensure that you follow the instructions on the tin and protect your flooring during polishing.
- Pewter, Antique Bronze and Antique Brass If these finishes become contaminated the only option is to polish them with a propriety metal polish and allow them to age again naturally. Ensure that you follow the instructions on the tin and protect your flooring during polishing.

Premier Trim Ramp 14mm & 16mm



- Use on hard 'Non Porous' floors.
- Ideal for floors which are fitted over under floor heating.
- Covers height differences of 14mm and 16mm.
- Nine finishes: Antique Brass, Antique Bronze, Brass, Brushed Chrome, Chrome, Pewter, Polished Nickel, Satin Brass and Satin Nickel.

Ramp 14mm & 16mm Prices

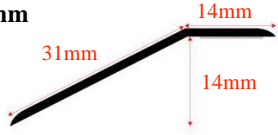
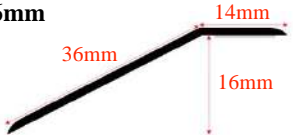
Profile Type	Size	Single Price		50 Price (Any Trims)	
		Standard	Specialised	Standard	Specialised
Ramp 14mm 	90cm	£12.60	£17.01	£11.34	£15.31
	180cm	£25.20	£34.02	£22.68	£30.62
	270cm	£37.80	£51.03	£34.02	£45.93
Ramp 16mm 	90cm	£13.27	£17.71	£11.94	£15.94
	180cm	£26.54	£35.42	£23.88	£31.88
	270cm	£39.81	£53.13	£35.82	£47.82

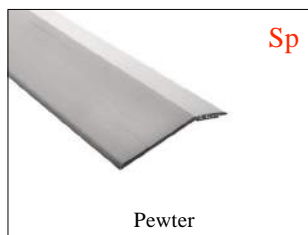
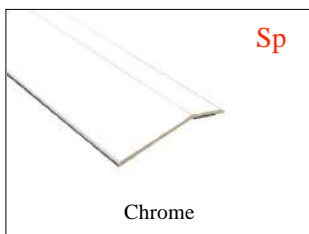

Carriage paid on 5 and over on this item. Less than 5 £7.50 carriage charge.



Technical



64

Product

- The Premier Ramp range of door bars are a high quality product for a high quality installation.
- The Premier Ramp range are available in three lengths: 90cm, 180cm and 270cm.

Fitting

- The Premier Ramp range is for use on 'Non Porous' hard floor to hard floor installations where floating is required and /or under floor heating is an issue. Can also be used in a 'No Float' situation.

ANY QUESTIONS
Please call 01207 591176 For friendly expert advice.

- For use when encountering height differences of 14mm, 16mm.
- Simply clean the floor surface and stick down.

NOTE: For expansion information consult the flooring manufacturers specifications.



14mm Ramp

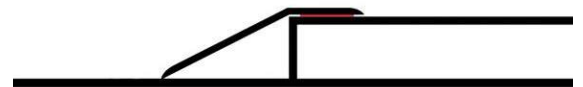

16mm Ramp

Get your Drop Checker



Ask your Stairrods UK Sales Representative.

Care and Maintenance

- Satin Brass and Polished Brass Trims can be left to age (oxidise) for a natural finish. However to keep the brass like new these two finishes will need to be polished from time to time with a propriety brass polish. Ensure that you follow the instructions on the tin and protect your flooring during polishing.
- Satin Nickel, Chrome, and Brushed Chrome These finishes will need to be polished from time to time with a propriety metal polish. Ensure that you follow the instructions on the tin and protect your flooring during polishing.
- Pewter, Antique Bronze and Antique Brass If these finishes become contaminated the only option is to polish them with a propriety metal polish and allow them to age again naturally. Ensure that you follow the instructions on the tin and protect your flooring during polishing.



- The Premier Lips are a versatile section with many uses.
- Use it as a tile edge or to create a mat well. It will form a tidy edge against your french window or use it as a Scotia where the flooring is 10mm deep or over.
- Used in combination with our Shims the lips will allow you to deal with a height difference at a doorway of up to 35mm.

Lip Prices

Profile Type	Size	Single Price		50 Price (Any Trim)	
		Standard	Specialised	Standard	Specialised
	90cm	£7.51	£11.84	£6.76	£10.66
	180cm	£15.02	£23.38	£13.52	£21.32
	270cm	£22.53	£33.52	£20.28	£31.98

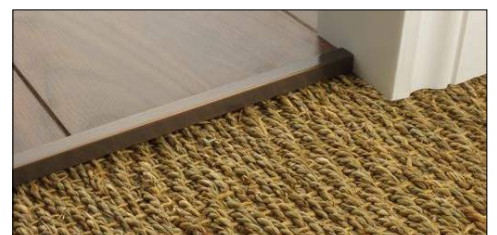
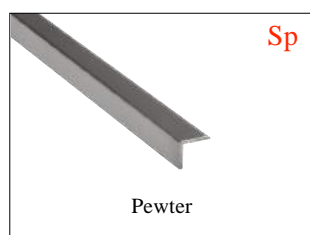
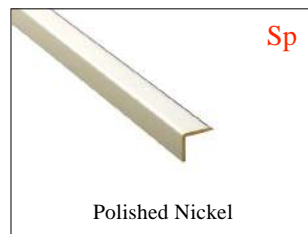
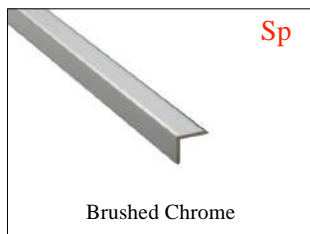
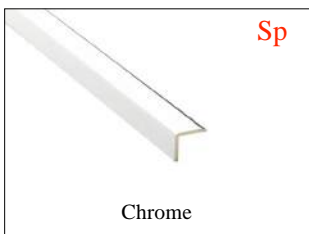
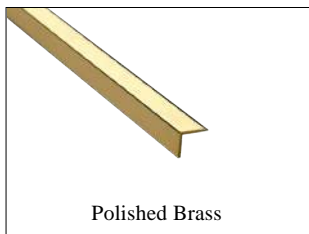

Carriage paid on 5 and over on this item. Less than 5 £7.50 carriage charge.



Technical



66

Product

- The Premier Lips range of edges are a high quality stick down product for a high quality installation.
- The Premier Lips range are available in nine colours and three lengths: 90cm, 180cm and 270cm. See facing page for details.
- The Premier Lips range can be used for a 'Non Porous' ceramic edge, wood edge, french window edge, room edge and when used with our shims on page 31 a 'Shim Combo' up to 35mm, the list is endless.
- The lips will come fitted with Tape Option 1 unless otherwise stated. Other tape options are 2 and 3, see below for description and situation suitability.

ANY QUESTIONS
Please call 01207 591176 For friendly expert advice.

Fitting Tape Option 1

- This fitting option is for where the front face of the edge is rough or uneven but the top face is smooth and able to provide a good surface for the tape to stick.



Fitting Tape Option 2

- This fitting option is for where the top face of the edge is rough or uneven but the front face is smooth and able to provide a good surface for the tape to stick.



Fitting Tape Option 3

- This fitting option is for a room edge where the Lip would be attached to the skirting and protrude into the room to cover the expansion joint of laminate or engineered flooring deeper than 10mm. It can also be used to cover an untidy tile edge, for example around a kitchen floor.



Care and Maintenance

- Satin Brass and Polished Brass Trims can be left to age (oxidise) for a natural finish. However to keep the brass like new these two finishes will need to be polished from time to time with a propriety brass polish. Ensure that you follow the instructions on the tin and protect your flooring during polishing.
- Satin Nickel, Chrome, and Brushed Chrome These finishes will need to be polished from time to time with a propriety metal polish. Ensure that you follow the instructions on the tin and protect your flooring during polishing.
- Pewter, Antique Bronze and Antique Brass If these finishes become contaminated the only option is to polish them with a propriety metal polish and allow them to age again naturally. Ensure that you follow the instructions on the tin and protect your flooring during polishing.

Premier Trim Little Lip



- The Premier Little Lips are a versatile section with many uses.
- Use it as a tile edge or to create a mat well. It will form a tidy edge against your french window or use it as a Scotia where the flooring is 4mm deep or over.

Little Lip Prices

Profile Type	Size	Single Price		50 Price (Any Trims)	
		Standard	Specialised	Standard	Specialised
	90cm	£7.70	£11.20	£6.93	£10.08
	180cm	£15.40	£22.40	£13.86	£20.16
	270cm	£23.10	£33.60	£20.79	£30.24

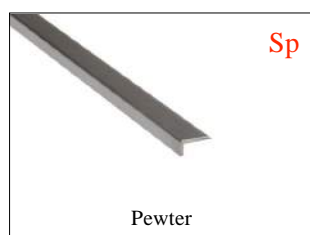
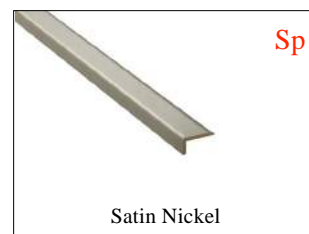
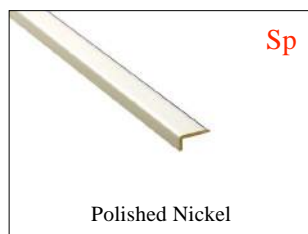
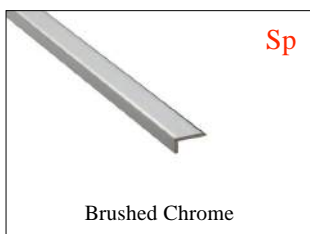
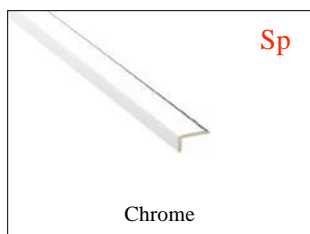
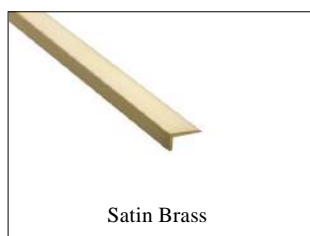
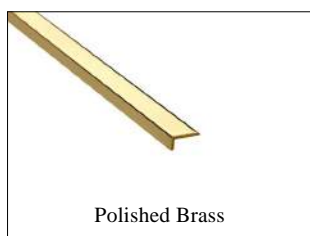

Carriage paid on 5 and over on this item. Less than 5 £7.50 carriage charge.



Technical



Product

- The Premier Little Lips range of edges are a high quality stick down product for a high quality installation.
- The Premier Little Lips range are available in nine colours and three lengths: 90cm, 180cm and 270cm. See facing page for details.
- The Premier Little Lips range can be used as a ‘Scotia or a ceramic edge, wood edge, french window edge.
- The Little Lips will come fitted with Tape Option 1 unless otherwise stated. Other tape option is 2 see below for description and situation suitability.

ANY QUESTIONS
Please call 01207 591176 For friendly expert advice.

Fitting Tape Option 1

- This fitting option is for where the Little Lip is being used as a ‘Scotia’.



Fitting Tape Option 1

- This fitting option is for where the front face of the edge is rough or uneven but the top face is smooth and able to provide a good surface for the tape to stick.



Care and Maintenance

- Satin Brass and Polished Brass Trims can be left to age (oxidise) for a natural finish. However to keep the brass like new these two finishes will need to be polished from time to time with a propriety brass polish. Ensure that you follow the instructions on the tin and protect your flooring during polishing.
- Satin Nickel, Chrome, and Brushed Chrome These finishes will need to be polished from time to time with a propriety metal polish. Ensure that you follow the instructions on the tin and protect your flooring during polishing.
- Pewter, Antique Bronze and Antique Brass If these finishes become contaminated the only option is to polish them with a propriety metal polish and allow them to age again naturally. Ensure that you follow the instructions on the tin and protect your flooring during polishing.

Premier Trim Little Nose



- LVT small nosing.
- Nine finishes: Antique Brass, Antique Bronze, Brass, Brushed Chrome, Chrome, Pewter, Polished Nickel, Satin Brass and Satin Nickel.

Little Nose Prices

Profile Type	Size	Single Price		50 Price (Any Trims)	
		Standard	Specialised	Standard	Specialised
	90cm	£10.36	£13.86	£9.32	£12.47
	180cm	£20.72	£27.72	£18.64	£24.94
	270cm	£31.08	£41.58	£27.96	£37.41

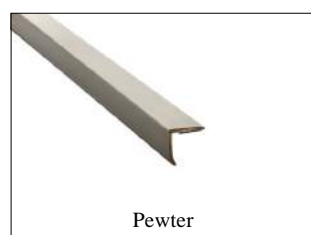
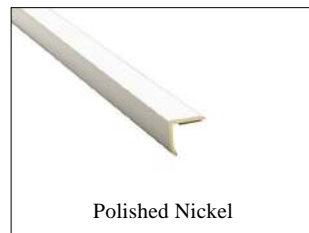
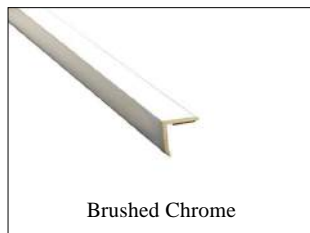
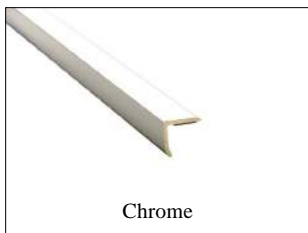
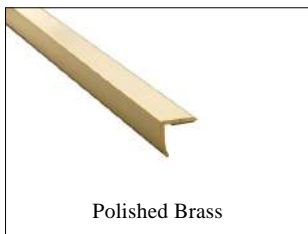

Carriage paid on 5 and over on this item. Less than 5 £7.50 carriage charge.



Technical



70

Product

- The Premier Little Little Nose range of edges are high quality stick down products for high quality installations.
- The Premier Little Little Nose range are available in nine colours and three lengths. See facing page for details.
- The Premier Little Little Nose range can be used for a 'Non Porous' stair nosing where the stair has LVT fitted to the tread or tread and riser.
- The Little Little Nose will come fitted with high quality tape for adhering to the tread.

ANY QUESTIONS
Please call 01207 591176 For friendly expert advice.

Fitting

- First ensure all surfaces are clean and free of dust and grease. The Little Nose should be fitted immediately after cleaning, do not clean all of the steps and then fit all of the nosing as dust can accumulate in the mean time.
- Prior to removing the backing tape, lay the nosing in position and mark the position of the back edge with pieces of masking tape, this will be your guide for positioning the nosing during fitting. This needs to be done as it gives the exact final position of the nosing allowing for variations in the rake of the risers.



- Lay a small bead of flooring adhesive along the inside front face of the nosing, this will give extra grip and adhesion.

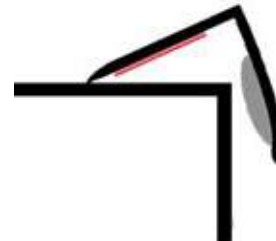

- Line the edge of the nosing up with the masking tape keeping the top face of the nosing at 45° to the tread so as not to allow the tape to make contact with the surface of the tread.



- When lined up bring the nosing down level with the tread and apply pressure along the top face of the nosing.

Care and Maintenance

- Satin Brass and Polished Brass Trims can be left to age (oxidise) for a natural finish. However to keep the brass like new these two finishes will need to be polished from time to time with a propriety brass polish. Ensure that you follow the instructions on the tin and protect your flooring during polishing.
- Satin Nickel, Chrome, and Brushed Chrome These finishes will need to be polished from time to time with a propriety metal polish. Ensure that you follow the instructions on the tin and protect your flooring during polishing.
- Pewter, Antique Bronze and Antique Brass If these finishes become contaminated the only option is to polish them with a propriety metal polish and allow them to age again naturally. Ensure that you follow the instructions on the tin and protect your flooring during polishing.



- Premier Little T has a 14mm wide top and allows for slight imperfections in joints and enables a gap between floor finishes to be incorporated during installation to allow for natural expansion in flooring materials such as ceramics and wood.
- Premier Little T is fitted after the floorcoverings have been installed, making them ideal for use when the installation of the floorcoverings is undertaken by different trades (e.g. ceramic contractors and flooring contractors) where the trims cannot be fixed until both floors have been completed.

Little T Prices

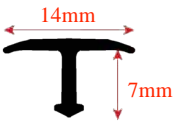
Profile Type	Size	Single Price		50 Price (Any Trims)	
		Standard	Specialised	Standard	Specialised
	90cm	£7.84	£11.34	£7.06	£10.21
	180cm	£15.68	£22.68	£14.12	£20.42
	270cm	£23.52	£34.02	£21.18	£30.63

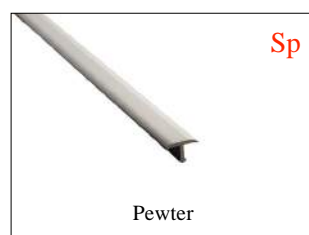
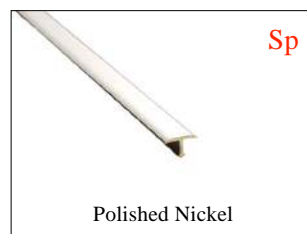
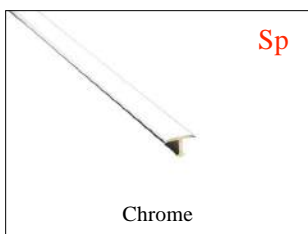
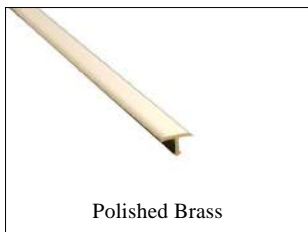

Carriage paid on 5 and over on this item. Less than 5 £7.50 carriage charge.



The Product

- The Little T range of door bars are available in two profile sizes
- The Little T range are made to as a join between two stone or ceramic floors.

Little T

- For stone or ceramic floors not lower than 7mm. Why not use the Stairrods Drop Checker, see below.



ANY QUESTIONS
Please call 01207 591176 For friendly expert advice.

Get your Drop Checker



Ask your Stairrods UK Sales Representative.

Fitting

- Apply a proprietary adhesive to the channel between the two floor surfaces ensuring that you do not over fill the channel as this will result in the adhesive overflowing on to the flooring surface when the T is pressed into place.

Care and Maintenance

- Satin Brass and Polished Brass Trims can be left to age (oxidise) for a natural finish. However to keep the brass like new these two finishes will need to be polished from time to time with a propriety brass polish. Ensure that you follow the instructions on the tin and protect your flooring during polishing.
- Satin Nickel, Chrome, and Brushed Chrome These finishes will need to be polished from time to time with a propriety metal polish. Ensure that you follow the instructions on the tin and protect your flooring during polishing.
- Pewter, Antique Bronze and Antique Brass If these finishes become contaminated the only option is to polish them with a propriety metal polish and allow them to age again naturally. Ensure that you follow the instructions on the tin and protect your flooring during polishing.

Premier Trim Big T



- Premier Big T has a 25mm wide top and allows for slight imperfections in joints and enables a gap between floor finishes to be incorporated during installation to allow for natural expansion in flooring materials such as ceramics and wood.
- Premier Big Tile is fitted after the floorcoverings have been installed, making them ideal for use when the installation of the floorcoverings is undertaken by different trades (e.g. ceramic contractors and flooring contractors) where the trims cannot be fixed until both floors have been completed.

Big T Prices

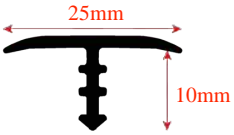
Profile Type	Size	Single Price		50 Price (Any Trims)	
		Standard	Specialised	Standard	Specialised
	90cm	£10.64	£14.14	£9.58	£12.73
	180cm	£21.28	£28.28	£19.16	£25.46
	270cm	£31.92	£42.42	£28.74	£38.19

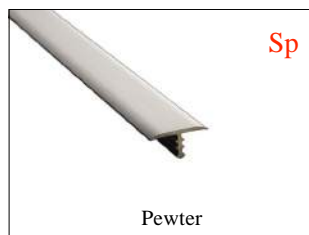
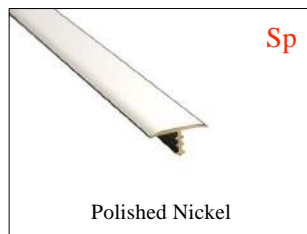

Carriage paid on 5 and over on this item. Less than 5 £7.50 carriage charge.



The Product

- The Big T range of door bars are available in two profile sizes
- The Big T range are made to as a join between two stone or ceramic floors.

Big T

- For stone or ceramic floors not lower than 10mm. Why not use the Stairrods Drop Checker, see below.

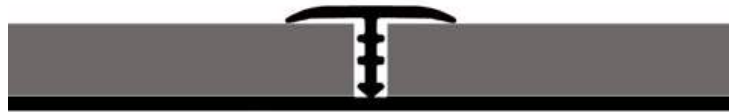

ANY QUESTIONS
Please call 01207 591176 For friendly expert advice.

Get your Drop Checker



Ask your Stairrods UK Sales Representative.

Fitting

- Apply a proprietary adhesive to the channel between the two floor surfaces ensuring that you do not over fill the channel as this will result in the adhesive overflowing on to the flooring surface when the T is pressed into place.

Care and Maintenance

- Satin Brass and Polished Brass Trims can be left to age (oxidise) for a natural finish. However to keep the brass like new these two finishes will need to be polished from time to time with a propriety brass polish. Ensure that you follow the instructions on the tin and protect your flooring during polishing.
- Satin Nickel, Chrome, and Brushed Chrome These finishes will need to be polished from time to time with a propriety metal polish. Ensure that you follow the instructions on the tin and protect your flooring during polishing.
- Pewter, Antique Bronze and Antique Brass If these finishes become contaminated the only option is to polish them with a propriety metal polish and allow them to age again naturally. Ensure that you follow the instructions on the tin and protect your flooring during polishing.



- A universal, anodised carpet trim.
- Available in Brass, Bronze, Chrome, Pewter, Satin Brass and Satin Nickel.

Joint Prices

32" length (81.3cm)	£13.26
36" length (91.5cm)	£14.38
96" length (243.8cm)	£39.77
Note: Chrome only available in lengths up to 72" (182.9cm)	£30.11

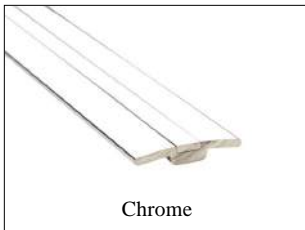
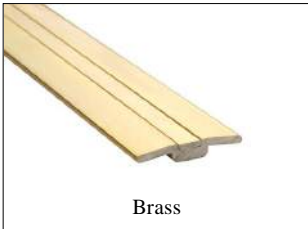

Carriage paid on 4 and over on this item. Less than 5 £7.50 carriage charge.



Product

- The Joints range of Aluminium door bars.
- The Joints range are available in three lengths: 81cm, 91cm and 243cm. (Chrome only available up to 182cm.)

Fitting

- The Joints range can be used for a carpet to carpet and carpet to hard floor and hard floor to hard floor installations where expansion is a requirement.
- The Joints are a screw down product and the screw heads are then hidden using the stick down inlay.
- When using on a carpet to carpet installation you must still use gripper and fit the Joints over the gripper to give the carpet a good grip making sure the Joint is screwed down firm enough so as not to allow the screws to lift and interfere with the inlay.

ANY QUESTIONS
Please call 01207 591176 For friendly expert advice.



- When using on carpet to hard floor fit the Joint over the gripper on the carpet side and rest the other edge on the hard floor and screw down making sure the Joint is screwed down firm enough so as not to allow the screws to pop up and interfere with the inlay.



- When using on hard floor to hard floor ensure a gap of 12mm between the surfaces to accommodate the underside of the fitting channel, again screw down firmly to prevent the screws from lifting the inlay from its channel.



- When using on hard floor to hard floor with a height difference the Joint will accommodate up to a 6mm edge, again screw down firmly to prevent the screws from lifting the inlay from its channel.



Care and Maintenance

- We recommend using a damp cloth to keep the rods clean, any household cleaners used to clean the wood and paint work of the staircase should be applied to the cloth and not directly onto the surface of the stair, as over spray can cause a speckled tarnish on the rods. If any liquids are inadvertently spilt on the stair rods they should be cleaned immediately with a damp cloth and dried with a clean cloth.



- Available in Standard and Specialised colours.
- Minimum order of 15 meters
- Available in cut lengths from 15m to 50m
- Available in 50m spools (1 spool = 1 colour)
- Note: Spools may contain joins.

Easybind Prices

Available in Standard Colours (ST) and Specialised Colours (SP)	Standard	Specialised
15m-50m lengths. Available in smaller quantities with a £7.50 carriage charge.	£2.51 per metre	£3.51 per metre
50m spool.	£2.05 per metre	£3.05 per metre
2 x 50m spool.	£1.83 per metre	£2.83 per metre



Beige, Black & Brown

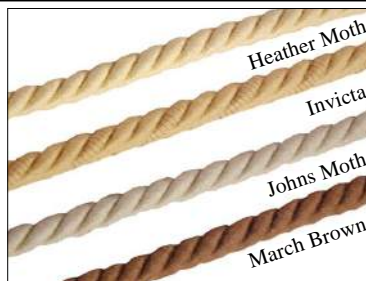

Beige, Black & Brown



Blue, Green & Grey



Blue, Green & Grey



Pinks & Red



Multi Colour



Multi Colour



Specialised



Specialised



The Product

- Easybind is a simple but effective alternative to whipping carpet edges on stair runners and rugs. Easybind can be fitted to the carpet on site so no delays in waiting for the carpet to be whipped.

Easybind Carpet Edging For Carpet Runners and Rugs.

- Simply measure the edges of the carpet where you will be fitting the Easybind and allow a little extra then cut accordingly.

ANY QUESTIONS
Please call 01207 591176 For friendly expert advice.



Prepare the carpet edges by cutting with a sharp knife to produce a clean cut. Be aware of any surface below the carpet when cutting so as not to cause damage.



Easybind will fray when cut so to prevent this apply adhesive tape around the rope at the cutting point.



Always start in the middle of a straight run as it is easier to produce a clean join on a straight section as opposed to a curve or corner. Peel backing off the adhesive tape.



Be sure to run the rope edging parallel to the carpet edge leaving a gap to accommodate the glue gun nozzle.



When going around an outside corner cut the binding not the rope and fold underneath, the same applies to an inside corner without the need to fold the binding on the back.



When creating a join apply adhesive tape to the area that will be cut, this prevents the rope edging from fraying when being cut.



After cutting match the rope pieces together. **TIP:** Have the ends of the adhesive tape visible to allow ease of removal. Seal the two pieces of rope with a spot of hot glue and peel the tape away.



When you are happy with the join and the corners etc. Use the hot glue gun to apply a bead of glue between the binding and the carpet backing, pinching together as you go. Be careful not to get glue on the carpet.



For longer runs try a piece of 3" x 2" to help attach large sections of the binding. Use a glue gun pad when the gun is not in use to avoid glue dripping onto either the floor or carpet.

Point of sale material



**Rods & Trims
Sample Display**
£42 for a set of 21 x 24"
Mounting Board not included



**Premier Trim Display
(for Carpets)**
£35 inc DoubleZ™M9



**Premier Trim Display
(for Hard Flooring)**
£35 inc Two-way 2-3mm Ramp



Flip Staircase
£35



Joint Display
- FOC



Jubilee Display
- FOC



Stair Rod Box
- £20



**Premier Trim Estimator
Box**
- FOC



Easybind Swatch Box
-FOC