



Account Number

# UK Trade Price List

## 1st October 2021

All Prices exclude VAT

### Price Increase

20% Increase on Easyshims

5% Increase on Ali Trims

3% Increase on Easybind

5% Increase on Premier Trim Dividers

5% Increase on Tudor Stair Rods



Ali LVT Wrap Nosing WPC/SPC 5mm – Installing floors in our trims – page 85

Ali Bendybull Nosing WPC/SPC – Installing floors in our trims – page 87

Ali Zeebar - Page 99

Gripper - G7.5mm 3 Row Medium, G7.5mm 3 Row Short Pin,  
G7.5mm Blind & Hook Tape - Page 101

Premier Trims available at 100cm with a 10% surcharge.

## **Stairrods (UK) Ltd.**

Unit 6, Park Road North Ind. Est.,

Blackhill, Consett, Co. Durham

DH8 5UN

**Tel: +44 (0) 1207 591176**

**Fax: +44 (0) 1207 591911**

**Email: [sales@stairrods.co.uk](mailto:sales@stairrods.co.uk)**

**[www.stairrods.co.uk](http://www.stairrods.co.uk)**

Carriage Guidelines on the back page



# Contents



## Stair Rods

Page 3

5	Royale
7	Eastern Promise
9	Crystal
11	Premier
13	Country
15	Vision
17	Tudor
19	Blacksmith
21	Jubilee
21	Homepride

## Accessories

23	Victorian Stair Clips
25	Skiffers
26	Easystuds
27	Decorative Pipe Covers

## Easyshims

29	Easyshims
31	Easychocks & Easywedges

## Premier Trims

33	DoubleZ™4
35	DoubleZ™9
37	DoubleZ™13
39	Slim D
41	Slim Z
43	Single 4
45	Single 9
47	Single 13
49	Square
51	Posh
53	Covers
55	Floating Euro Cover
57	Vinyl Edges
59	Two-Way Ramps
61	Ramps
63	Carpet Ramp
65	Dividers
67	 Inlays
69	LVT Nosing (no bull)
71	LVT Nosing (full bull)
73	Bendy Bull
75	Lips
77	Ts
79	LVT Matwell (non floating)
81	LVT Matwell (floating)



## Ali Trims

- 83 Ali Top Nose
- 85  Ali Wrap Nosing
- 87  Ali Bendybull Nosing
- 89 Ali Tramline Transition
- 91 Ali TramlineZ
- 93 Ali Tramline Reducers
- 95 Ali Tramline End Profile
- 97 Ali Pipe Covers
- 99  Ali Zee Bar

## Gripper

- 101  Gripper

## Carpet Edging

- 103 Easybind

“All flooring materials should be installed in accordance with their relevant British Standard, if installed incorrectly this could result in possible failure and have a detrimental affect on our profiles”

# Royale Stair Rods



- Available for runner and fully fitted carpets.
- Three finial designs: Beaumont, Louis, Vue.
- Ten finishes: Antique Brass, Antique Bronze, Black, Brass, Brushed Chrome, Chrome, Pewter, Polished Nickel, Satin Brass, Satin Nickel.
- All finial designs are available in all colours in any combination.

## Royale Prices

Hollow Triangular Rod	Runner	Fully Fitted
For any length up to 36" (91.5cm), thereafter add 55p/inch (2.5cm)	£25.46	£22.72





## **Product**

- The Royale range of stair rods are available for either a runner carpet or fully fitted.
- The Royale range are made to measure, see below for measuring guidelines.

## **Royale Stair Rod For Carpet Runner.**

- We recommend that you add 6 inches (15cm) to the width of your carpet and use this measurement to give you the tip length of the stair rod.

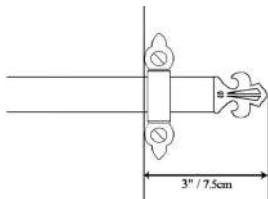

- Our standard runner bracket clearance is 10mm. Not recommended for deep pile carpets.

ANY QUESTIONS  
Please call 01207 591176 For friendly expert advice.

## **Royale Rod For Fully Fitted Carpet.**

- Depending on the width of the stair we recommend that you leave a 1 to 2 inch (2.5 to 5cm) gap between the stringboard and the tip of the rod at both sides of the staircase.

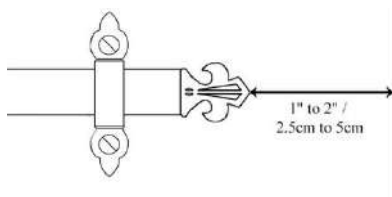

## **Fitting Rods To Stair.**

- Both runner and fully fitted brackets are supplied with number 6 screws and you must drill a pilot hole before fixing the brackets to the stair. For softwood create a 2.5mm pilot hole and for hardwood create a 3mm hole. A clearance hole of 4mm should be drilled to accommodate the screw shank. Remember to set your power drill on a low torque setting to avoid breaking the screws. For fully fitted carpets the supplied bracket sits on top of the rod and screws fix it through the carpet.

## **Care and Maintenance**

- We recommend using a damp cloth to keep the rods clean, any household cleaners used to clean the wood and paint work of the staircase should be applied to the cloth and not directly onto the surface of the stair, as over spray can cause a speckled tarnish on the rods. If any liquids are inadvertently spilt on the stair rods they should be cleaned immediately with a damp cloth and dried with a clean cloth.

# Eastern Promise Stair Rods



- Available in three rod styles: Plain, Reeded and Spiral, for runner and fully fitted carpets.
- Three finial designs: Dubai, Cairo, and Dune.
- Ten finishes: Antique Brass, Antique Bronze, Black, Brass, Brushed Chrome, Chrome, Pewter, Polished Nickel, Satin Brass and Satin Nickel.
- All finial designs are available in all colours and rod styles in any combination.
- Spiral rod only available up to 43" on this range.

## Eastern Promise Prices

Hollow 5/8" Rod	Runner	Fully Fitted
<b>PLAIN ROD</b> 5/8" (16mm). For any length up to 36" (91.5cm), thereafter add 31p/inch (2.5cm)	£21.55	£18.87
<b>SPIRAL OR REEDED</b> 5/8" (16mm). For any length up to 36" (91.5cm), thereafter add 31p/inch (2.5cm)	£23.21	£21.04



Cairo Polished Brass Plain



Dubai Satin Brass Reeded



Dune Antique Spiral



Dubai Antique Bronze Plain



Dune Chrome Reeded



Cairo Brushed Chrome Spiral



Dune Polished Nickel Plain



Dune Satin Nickel Reeded



Cairo Black Spiral

Fully Fitted



Dubai Pewter Plain



## **Product**

- The Eastern Promise range of stair rods are available for either a runner carpet or fully fitted.
- The Eastern Promise range are made to measure, see below for measuring guidelines.

## **Eastern Promise Stair Rod For Carpet Runner.**

- We recommend that you add 6 inches (15cm) when choosing the Cairo or Dubai finial, to the width of your carpet and use this measurement to give you the tip to tip length of the stair rod. If choosing the Dune finial add ,5 inches (11cm).

**NOTE: Tip to tip measurement includes the finials.**

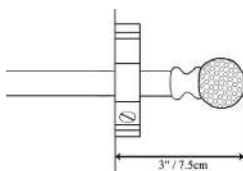

- Our standard runner bracket for this range has a clearance of 16mm however if you have either a deep pile carpet or thin carpet please call for advice.

ANY QUESTIONS  
Please call 01207 591176 For friendly expert advice.

## **Eastern Promise Rod For Fully Fitted Carpet.**

- Depending on the width of the stair we recommend that you leave a 1 to 2 inch (2.5 to 5cm) gap between the stringboard and the tip of the rod at both sides of the staircase.

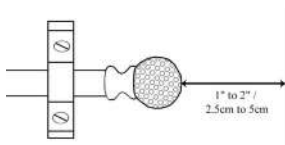

## **Prepare Hinge Brackets For fitting**

- The brackets for runner carpets are hinged and consist of a bottom and top section and cannot be mixed with the top or bottom of other brackets. To fit the brackets the top and bottom must be separated to allow access to the screw holes. This requires little effort and is accomplished by removing the dome head screw and placing your thumbs on the hinge part of the bracket and first two fingers on the inside of the top and bottom and gently ease open the bracket. This will loosen the hinge and allow you to slide them apart.

## **Fitting Rods To Stair.**

- Both runner and fully fitted brackets are supplied with number 6 screws and you must drill a pilot hole before fixing the brackets to the stair. For softwood create a 2.5mm pilot hole and for hardwood create a 3mm hole. A clearance hole of 4mm should be drilled to accommodate the screw shank. Remember to set your power drill on a low torque setting to avoid breaking the screws. With the hinged bracket separated fit the bottom half to the stair and put the rod in place then re fit the top half of the bracket by sliding the two half together, finally close with the dome head screw. For fully fitted carpets the supplied bracket sits on top of the rod and screws fix it through the carpet.

## **Care and Maintenance**

- We recommend using a damp cloth to keep the rods clean, any household cleaners used to clean the wood and paint work of the staircase should be applied to the cloth and not directly onto the surface of the stair, as over spray can cause a speckled tarnish on the rods. If any liquids are inadvertently spilt on the stair rods they should be cleaned immediately with a damp cloth and dried with a clean cloth.

# Crystal Stair Rods



- Available in three rod styles: Plain, Reeded and Spiral, for runner and fully fitted carpets.
- Four crystal colours: Amber, Rainbow, Rose, Sky.
- Ten finishes: Antique Brass, Antique Bronze, Black, Brass, Brushed Chrome, Chrome, Pewter, Polished Nickel, Satin Brass and Satin Nickel.
- All finial designs are available in all colours and diameters in any combination.
- Spiral rod only available up to 42" on this range.

## Crystal Prices

Hollow 1/2" Rod	Runner	Fully Fitted
<b>PLAIN ROD</b> 1/2" (12mm). For any length up to 36" (91.5cm), thereafter add 25p/inch (2.5cm)	£13.94	£13.29
<b>SPIRAL OR REEDED</b> 1/2" (12mm). For any length up to 36" (91.5cm), thereafter add 25p/inch (2.5cm)	£16.06	£15.41

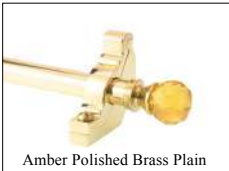

Amber Polished Brass Plain



Rainbow Satin Brass Reeded



Rose Antique Brass Spiral



Sky Antique Bronze

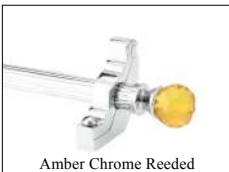

Amber Chrome Reeded



Rainbow Brushed Chrome Spiral



Rose Polished Nickel Plain



Sky Satin Nickel Reeded



Rainbow Black Plain

Fully Fitted



Amber Pewter Spiral



## Product

- The Crystal range of stair rods are available for either a runner carpet or fully fitted.
- The Crystal range are made to measure, see below for measuring guidelines.

## Crystal Stair Rod For Carpet Runner.

- We recommend that you add 4 inches (10cm) to the width of your carpet and use this measurement to give you the tip to tip length of the stair rod. **NOTE: Tip to tip measurement includes the finials.**

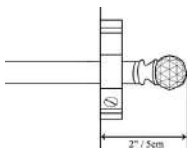

- Our standard runner bracket clearance is 14mm however if you have a deep pile carpet there is the option of using the 'High Clearance' bracket to give you 17mm clearance at a surcharge of £1.66 per rod.

Standard

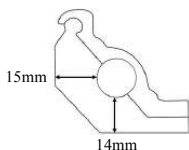

High Clearance

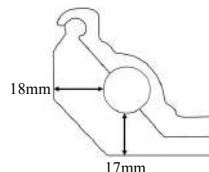

ANY QUESTIONS  
Please call 01207 591176 For friendly expert advice.

## Crystal Rod For Fully Fitted Carpet.

- Depending on the width of the stair we recommend that you leave a 1 to 2 inch (2.5 to 5cm) gap between the stringboard and the tip of the rod at both sides of the staircase.

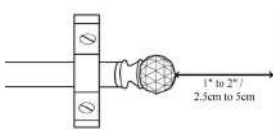

## Prepare Hinge Brackets For fitting

- The brackets for runner carpets are hinged and consist of a bottom and top section and cannot be mixed with the top or bottom of other brackets. To fit the brackets the top and bottom must be separated to allow access to the screw holes. This requires little effort and is accomplished by removing the dome head screw and placing your thumbs on the hinge part of the bracket and first two fingers on the inside of the top and bottom and gently ease open the bracket. This will loosen the hinge and allow you to slide them apart.

## Fitting Rods To Stair.

- Both runner and fully fitted brackets are supplied with number 6 screws and you must drill a pilot hole before fixing the brackets to the stair. For softwood create a 2.5mm pilot hole and for hardwood create a 3mm hole. A clearance hole of 4mm should be drilled to accommodate the screw shank. Remember to set your power drill on a low torque setting to avoid breaking the screws. With the hinged bracket separated fit the bottom half to the stair and put the rod in place then re fit the top half of the bracket by sliding the two half together; finally close with the dome head screw. For fully fitted carpets the supplied bracket sits on top of the rod and screws fix it through the carpet.

## Care and Maintenance

- We recommend using a damp cloth to keep the rods clean, any household cleaners used to clean the wood and paint work of the staircase should be applied to the cloth and not directly onto the surface of the stair, as over spray can cause a speckled tarnish on the rods. If any liquids are inadvertently spilt on the stair rods they should be cleaned immediately with a damp cloth and dried with a clean cloth.

# Premier Stair Rods



- Available in two diameters: 1/2" (12mm) and 5/8" (16mm).
- Six finial designs: Balmoral, Chatsworth, Lancaster, Hanover, Windsor and Woburn.
- Standard finishes: Antique Brass, Antique Bronze, Polished Brass and Satin Brass.
- Specialised finishes: Black, Brushed Chrome, Chrome, Pewter, Polished Nickel, and Satin Nickel.
- All finial designs are available in all colours and diameters in any combination.
- Hanover is not available in the 5/8".

## Premier Prices

Solid Core Rods	Runner		Fully Fitted		Fully Fitted Side Fix	
	ST	SP	ST	SP	ST	SP
<b>Finish:</b> ST = Standard SP = Specialised	ST	SP	ST	SP	ST	SP
1/2" (12mm) For any length up to 36" (91.5cm), thereafter add 35p/inch (2.5cm)	£19.79	£23.99	£17.09	£21.09	£12.72	£16.72
5/8" (16mm) For any length up to 36" (91.5cm), thereafter add 49p/inch (2.5cm)	£26.88	£32.13	£23.52	£28.52	£17.47	£22.47





## **Product**

- The Premier range of stair rods are available for either a runner carpet or fully fitted and in two diameters for runners and fully fitted, see facing page for details.
- The Premier range are made to measure, see below for measuring guidelines.

### **Premier Stair Rod For Carpet Runner.**

- For 1/2" rods we recommend that you add 4 inches (10cm) to the width of your carpet and use this measurement to give you the tip to tip length of the stair rod and for 5/8" 5 inches (12.5cm) over.

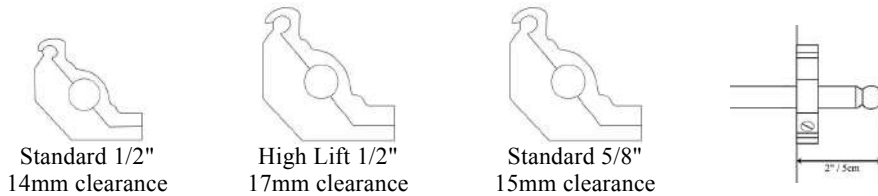

- Our standard runner bracket clearance is 14mm however if you have a deep pile carpet there is the option of using the 'High Clearance' bracket to give you 17mm clearance at a surcharge £1.66 per rod.

ANY QUESTIONS  
Please call 01207 591176 For friendly expert advice.

### **Premier Rod For Fully Fitted Carpet.**

- We recommend that you leave a 1 to 2 inch (2.5 to 5cm) gap between the stringboard and the tip of the rod at both sides of the staircase.

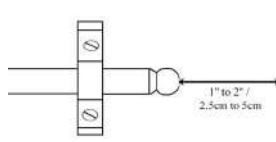

### **Prepare Hinge Brackets For fitting**

- The brackets for runner carpets are hinged and consist of a bottom and top section and cannot be mixed with the top or bottom of other brackets. To fit the brackets the top and bottom must be separated to allow access to the screw holes. This requires little effort and is accomplished by removing the dome head screw and placing your thumbs on the hinge part of the bracket and first two fingers on the inside of the top and bottom and gently ease open the bracket. This will loosen the hinge and allow you to slide them apart.

### **Fitting Rods To Stair.**

- Both runner and fully fitted brackets are supplied with number 6 screws and you must drill a pilot hole before fixing the brackets to the stair. For softwood create a 2.5mm pilot hole and for hardwood create a 3mm hole. A clearance hole of 4mm should be drilled to accommodate the screw shank. Remember to set your power drill on a low torque setting to avoid breaking the screws. With the hinged bracket separated fit the bottom half to the stair and put the rod in place then re fit the top half of the bracket by sliding the two half together, finally close with the dome head screw. For fully fitted carpets the supplied bracket sites on top of the rod and screws fix it through the carpet.

### **Care and Maintenance**

- We recommend using a damp cloth to keep the rods clean, any household cleaners used to clean the wood and paint work of the staircase should be applied to the cloth and not directly onto the surface of the stair, as over spray can cause a speckled tarnish on the rods. If any liquids are inadvertently spilt on the stair rods they should be cleaned immediately with a damp cloth and dried with a clean cloth.



- Available in three rod styles: Plain, Reeded and Spiral, for runner and fully fitted carpets.
- Available in two diameters: 1/2" and 5/8".
- Four finial designs: Arran, Balladeer, Bordeaux and Sherwood.
- Ten finishes: Antique Brass, Antique Bronze, Black, Brass, Brushed Chrome, Chrome, Pewter, Polished Nickel, Satin Brass and Satin Nickel.
- All finial designs are available in all colours and diameters and rod styles in any combination.
- Spiral rod only available up to 42" on this range.

## Country Prices

Hollow Rod	Runner	Fully Fitted	Fully Fitted Side Fix
<b>PLAIN ROD 1/2" (12mm)</b> For any length up to 36" (91.5cm), thereafter add 25p/inch (2.5cm)	£13.94	£13.29	£9.84
<b>SPIRAL OR REEDED 1/2" (12mm)</b> For any length up to 36" (91.5cm), thereafter add 25p/inch (2.5cm)	£16.06	£15.41	£11.96
<b>PLAIN ROD 5/8" (16mm)</b> For any length up to up to 36" (91.5cm), thereafter add 31p/inch (2.5cm)	£20.08	£17.92	£13.61
<b>SPIRAL OR REEDED 5/8" (16mm)</b> For any length up to 36" (91.5cm), thereafter add 31p/inch (2.5cm)	£22.21	£20.08	£15.74

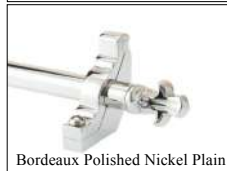



## Product

- The Country range of stair rods are available for either a runner carpet or fully fitted.
- The Country range are made to measure, see below for measuring guidelines.

## Country Stair Rod For Carpet Runner.

- For 1/2" rods we recommend that you add 4 inches (10cm) to the width of your carpet and use this measurement to give you the tip to tip length of the stair rod and 5/8" 5 inches (12.5cm) over. **NOTE: Tip to tip measurement includes the finials.**

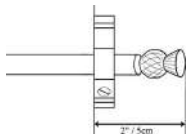

- Our standard runner bracket clearance is 14mm however if you have a deep pile carpet there is the option of using the 'High Clearance' bracket to give you 17mm clearance at a surcharge of £1.66 per rod. If you have a thinner carpet please call for advice.

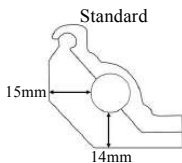

Standard

ANY QUESTIONS  
Please call 01207 591176 For friendly expert advice.

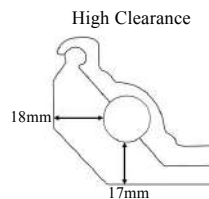

High Clearance

## Country Rod For Fully Fitted Carpet.

- Depending on the width of the stair we recommend that you leave a 1 to 2 inch (2.5 to 5cm) gap between the stringboard and the tip of the rod at both sides of the staircase.

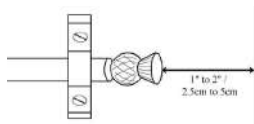

## Prepare Hinge Brackets For fitting

- The brackets for runner carpets are hinged and consist of a bottom and top section and cannot be mixed with the top or bottom of other brackets. To fit the brackets the top and bottom must be separated to allow access to the screw holes. This requires little effort and is accomplished by removing the dome head screw and placing your thumbs on the hinge part of the bracket and first two fingers on the inside of the top and bottom and gently ease open the bracket. This will loosen the hinge and allow you to slide them apart.

## Fitting Rods To Stair.

- Both runner and fully fitted brackets are supplied with number 6 screws and you must drill a pilot hole before fixing the brackets to the stair. For softwood create a 2.5mm pilot hole and for hardwood create a 3mm hole. A clearance hole of 4mm should be drilled to accommodate the screw shank. Remember to set your power drill on a low torque setting to avoid breaking the screws. With the hinged bracket separated fit the bottom half to the stair and put the rod in place then re fit the top half of the bracket by sliding the two half together, finally close with the dome head screw. For fully fitted carpets the supplied bracket sits on top of the rod and screws fix it through the carpet.

## Care and Maintenance

- We recommend using a damp cloth to keep the rods clean, any household cleaners used to clean the wood and paint work of the staircase should be applied to the cloth and not directly onto the surface of the stair, as over spray can cause a speckled tarnish on the rods. If any liquids are inadvertently spilt on the stair rods they should be cleaned immediately with a damp cloth and dried with a clean cloth.



- Available in three rod styles: Plain, Reeded and Spiral, for runner and fully fitted carpets.
- Three finial designs: Arrow, Piston and Sphere.
- Ten finishes: Antique Brass, Antique Bronze, Black, Brass, Brushed Chrome, Chrome, Pewter, Polished Nickel, Satin Brass and Satin Nickel.
- All finial designs are available in all colours, diameters and rod styles, in any combination.
- Spiral rod only available up to 41.5" on this range.

## Vision Prices

Hollow 1/2" Rod	Runner	Fully Fitted
<b>PLAIN ROD</b> 1/2" (12mm). For any length up to 36" (91.5cm), thereafter add 25p/inch (2.5cm)	£16.06	£14.39
<b>SPIRAL OR REEDED</b> 1/2" (12mm). For any length up to 36" (91.5cm), thereafter add 25p/inch (2.5cm)	£18.18	£16.51



Arrow Polished Brass Plain



Piston Satin Brass Reeded



Sphere Antique Brass Spiral



Piston Antique Bronze Plain



Sphere Chrome Reeded



Arrow Brushed Chrome Spiral



Sphere Polished Nickel Plain



Arrow Satin Nickel Reeded



Arrow Black Plain

Fully Fitted



Piston Pewter Spiral



## **Product**

- The Vision range of stair rods are available for either a runner carpet or fully fitted.
- The Vision range are made to measure, see below for measuring guidelines.

## **Vision Stair Rod For Carpet Runner.**

- We recommend that you add 4 inches (10cm) to the width of your carpet and use this measurement to give you the tip length of the stair rod. **NOTE: Tip to tip measurement includes the finials.**

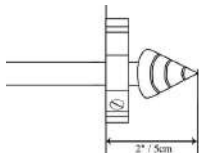

- Our standard runner bracket clearance is 14mm however if you have a deep pile carpet there is the option of using the 'High Clearance' bracket to give you 17mm clearance at a surcharge of £1.66 . If you have a thinner carpet please call for advice.

Standard

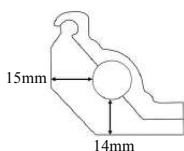

ANY QUESTIONS  
Please call 01207 591176 For friendly expert advice.

High Clearance

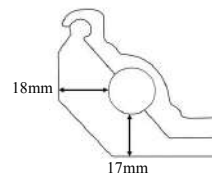

## **Vision Rod For Fully Fitted Carpet.**

- Depending on the width of the stair we recommend that you leave a 1 to 2 inch (2.5 to 5cm) gap between the stringboard and the tip of the rod at both sides of the staircase.

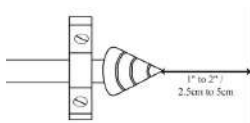

## **Prepare Hinge Brackets For fitting**

- The brackets for runner carpets are hinged and consist of a bottom and top section and cannot be mixed with the top or bottom of other brackets. To fit the brackets the top and bottom must be separated to allow access to the screw holes. This requires little effort and is accomplished by removing the dome head screw and placing your thumbs on the hinge part of the bracket and first two fingers on the inside of the top and bottom and gently ease open the bracket. This will loosen the hinge and allow you to slide them apart.

## **Fitting Rods To Stair.**

- Both runner and fully fitted brackets are supplied with number 6 screws and you must drill a pilot hole before fixing the brackets to the stair. For softwood create a 2.5mm pilot hole and for hardwood create a 3mm hole. A clearance hole of 4mm should be drilled to accommodate the screw shank. Remember to set your power drill on a low torque setting to avoid breaking the screws. With the hinged bracket separated fit the bottom half to the stair and put the rod in place then re fit the top half of the bracket by sliding the two half together, finally close with the dome head screw. For fully fitted carpets the supplied bracket sits on top of the rod and screws fix it through the carpet.

## **Care and Maintenance**

- We recommend using a damp cloth to keep the rods clean, any household cleaners used to clean the wood and paint work of the staircase should be applied to the cloth and not directly onto the surface of the stair, as over spray can cause a speckled tarnish on the rods. If any liquids are inadvertently spilt on the stair rods they should be cleaned immediately with a damp cloth and dried with a clean cloth.

# Tudor Stair Rods



- Available for runner and fully fitted carpets.
- Two wood colours: Light and dark.
- Ten finishes: Antique Brass, Antique Bronze, Black, Brass, Brushed Chrome, Chrome, Pewter, Polished Nickel, Satin Brass, Satin Nickel.
- All end detail finishes are available in both dark and light in any combination.

## Tudor Prices

Available in Dark and Light	Runner	Fully Fitted
For any length up to 36" (91.5cm), thereafter add 24p/inch (2.5cm)	£14.24	£13.01

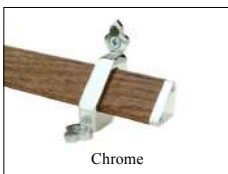
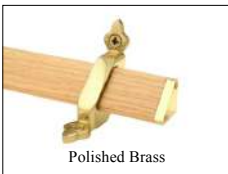

### Fully Fitted





## **Product**

- The Tudor range of stair rods are available for either a runner carpet or fully fitted.
- The Tudor range are made to measure, see below for measuring guidelines.

### **Tudor Stair Rod For Carpet Runner.**

- We recommend that you add 4 inches (10cm) to the width of your carpet and use this measurement to give you the tip length of the stair rod.

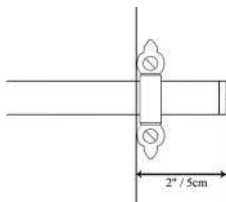

- Our standard runner bracket clearance is 10mm. Not recommended for deep pile carpets.

ANY QUESTIONS  
Please call 01207 591176 For friendly expert advice.

### **Tudor Rod For Fully Fitted Carpet.**

- Depending on the width of the stair we recommend that you leave a 1 to 2 inch (2.5 to 5cm) gap between the stringboard and the tip of the rod at both sides of the staircase.

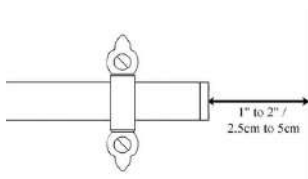

### **Fitting Rods To Stair.**

- Both runner and fully fitted brackets are supplied with number 6 screws and you must drill a pilot hole before fixing the brackets to the stair. For softwood create a 2.5mm pilot hole and for hardwood create a 3mm hole. A clearance hole of 4mm should be drilled to accommodate the screw shank. Remember to set your power drill on a low torque setting to avoid breaking the screws. For fully fitted carpets the supplied bracket sits on top of the rod and screws fix it through the carpet.

### **Care and Maintenance**

- We recommend using a damp cloth to keep the rods clean, any household cleaners used to clean the wood and paint work of the staircase should be applied to the cloth and not directly onto the surface of the stair, as over spray can cause a speckled effect on the lacquered rods. If any liquids are inadvertently spilt on the stair rods they should be cleaned immediately with a damp cloth and dried with a clean cloth.



- Available for runner and fully fitted carpets. *(Hinged bracket option now available for runner only)*
- Available in Black or Stainless Steel.
- 2 finial designs: Ball and Flat.
- Available in stock lengths (see below).
- Custom sizes available on request.

## Blacksmith Prices

Hand beaten stair rods available in stock lengths only, from 24"(60.9cm) to 48" (121.9cm) in 2" (5.08cm) increments. Available in Black (Standard) and Stainless Steel (Specialised) *Sp*. Hinged bracket option for runner only at the *Same Price*.

Black	24" (60.9cm) to 36" (91.4cm) lengths	£12.84
	38" (96.5cm) to 48" (121.9cm) lengths	£14.07
Stainless Steel <i>Sp</i>	24" (60.9cm) to 36" (91.4cm) lengths	£22.44

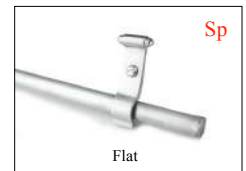
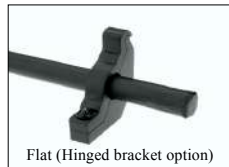



## **Product**

- The Blacksmith range of stair rods are available for either a runner carpet or fully fitted.
- The Blacksmith range are only available in stock lengths, see facing page.

### **Blacksmith Stair Rod For Carpet Runner.**

- We recommend that you add 4 inches (10cm) to the width of your carpet when choosing the Ball or Flat end, then use this measurement to give you the tip to tip length of the stair rod. This is the same for either the Universal or Hinged Bracket option.
- The Universal Blacksmith bracket can be used on both deep pile and thin carpets.
- If choosing the Hinged Bracket option bear in mind the clearance of the bracket is 14mm
- When used on a deep pile carpet the screw thread will be visible when viewed from the side.

ANY QUESTIONS  
Please call 01207 591176 For friendly expert advice.

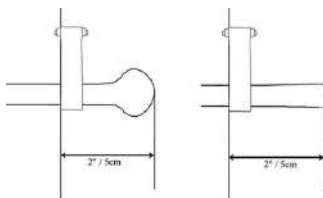

### **Blacksmith Rod For Fully Fitted Carpet.**

- Depending on the width of the stair we recommend that you leave a 1 to 2 inch (2.5 to 5cm) gap between the stringboard and the tip of the rod at both sides of the staircase.

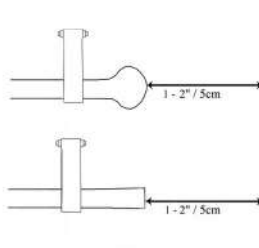

### **Fitting Rods To Stair.**

- Both runner and fully fitted brackets are supplied with number 8 screws and you must drill a pilot hole before fixing the brackets to the stair. For softwood create a 3mm pilot hole and for hardwood create a 3.5mm hole. A clearance hole of 4mm should be drilled to accommodate the screw shank. Remember to set your power drill on a low torque setting to avoid breaking the screws. For fully fitted carpets the bracket sits on top of the rod and screw fixes it through the carpet.

### **Care and Maintenance**

- We recommend using a damp cloth to keep the rods clean, any household cleaners used to clean the wood and paint work of the staircase should be applied to the cloth and not directly onto the surface of the stair, as over spray can cause a speckled tarnish on the rods. If any liquids are inadvertently spilt on the stair rods they should be cleaned immediately with a damp cloth and dried with a clean cloth.

# Jubilee Stair Rods



- Available for runner carpets.
- Eight finishes: Antique, Black, Brass, Satin Nickel, Chrome, Pewter, Bronze and Ivory.

## Jubilee Prices

<b>Option 1</b> For runners up to 27.5" (70cm) wide (stock size)	£4.90
<b>Option 2</b> For runners up to 35" (89cm) wide (stock size)	£5.90
<b>Option 3</b> For runners up to 47.25" (120cm) wide (stock size)	£6.90
<b>Option 4</b> For runners up to 59" (150cm) wide (stock size)	£7.90



Brass



Antique



Bronze



Chrome



Satin Nickel



Ivory



Black



Pewter





## Product

- The Jubilee range of stair rods are available for runner carpets only.
- The Jubilee range are available in four option sizes. See facing page for details
- Our Jubilee runner bracket clearance is 14mm

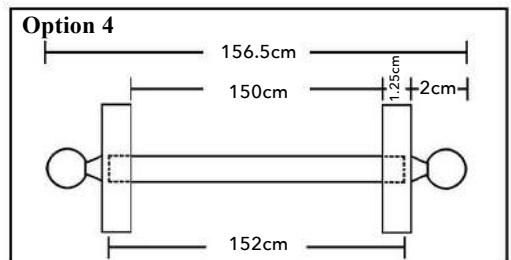
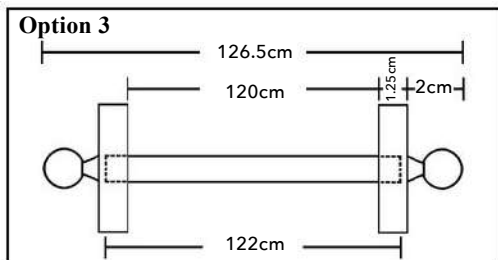
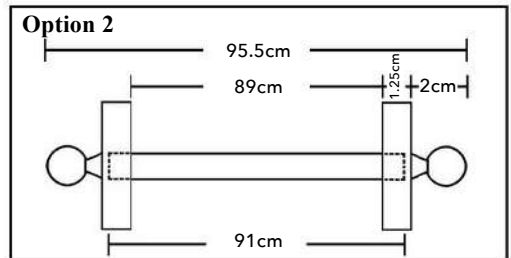
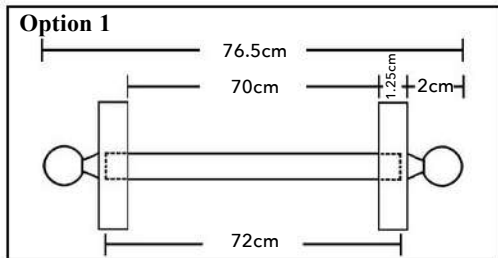

ANY QUESTIONS  
Please call 01207 591176 For friendly expert advice.

## Fitting Rods To Stair.

- The brackets are supplied with number 6 screws and you must drill a pilot hole before fixing the brackets to the stair. For softwood create a 2.5mm pilot hole and for hardwood create a 3mm hole. Remember to set your power drill on a low torque setting to avoid breaking the screws.
- Fit one bracket to the tread and riser then cut the rod to size and put in place. Now fit the second bracket.

## Cleaning

- We recommend using a damp cloth to keep the rods clean, any household cleaners used to clean the wood and paint work of the staircase should be applied to the cloth and not directly onto the surface of the stair, as over spray can cause a speckled tarnish on the rods. If any liquids are inadvertently spilt on the stair rods they should be cleaned immediately with a damp cloth and dried with a clean cloth.

# Homepride Stair Rods



- Available for runner carpets and fully fitted carpets.
- Eight finishes: Antique, Black, Brass, Bronze, Satin Nickel, Chrome, Pewter and Ivory.

## Homepride Prices

	Runner	Fully Fitted	Side Fix
<b>Option 1</b> For runners up to 27.5" (70cm) wide (stock size)	£7.72	£7.17	N/A
<b>Option 2</b> For runners up to 35" (89cm) wide (stock size)	£9.72	£9.11	£6.54
<b>Option 3</b> For runners up to 47.25" (120cm) wide (stock size)	£11.72	£11.12	£8.51
<b>Option 4</b> For runners up to 59" (150cm) wide (stock size)	£13.72	N/A	N/A



Fully Fitted



Side Fix (No Finials)





## Product

- The Homepride range of stair rods are available for runner and fully fitted carpets.
- The Homepride range are available in four option sizes. See facing page for details
- Our Homepride runner bracket clearance is 14mm

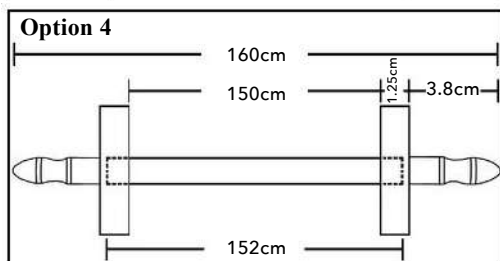
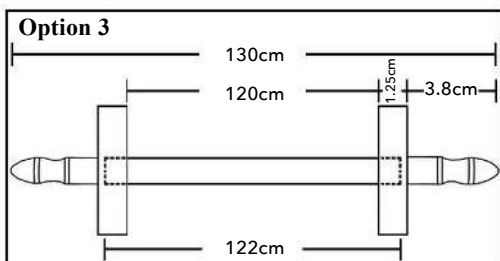
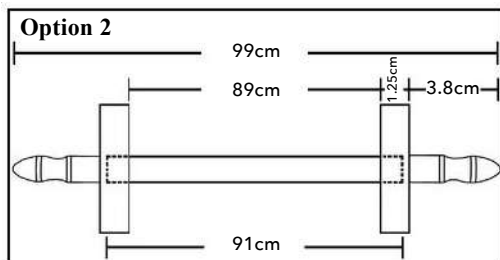
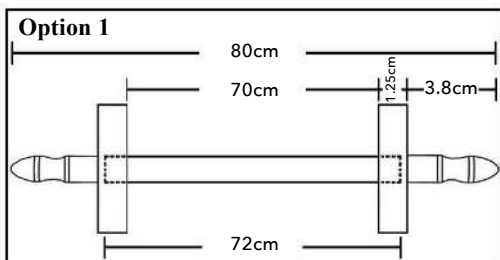

ANY QUESTIONS  
Please call 01207 591176 For friendly expert advice.

## Homepride Rod For Runner Carpet.

- The brackets are supplied with number 6 screws and you must drill a pilot hole before fixing the brackets to the stair. For softwood create a 2.5mm pilot hole and for hardwood create a 3mm hole. Remember to set your power drill on a low torque setting to avoid breaking the screws.
- Fit one bracket to the tread and riser then cut the rod to size and put in place. Now fit the second bracket.

## Homepride Rod For Fully Fitted Carpet.

- Depending on the width of the stair we recommend that you leave a 1 to 2 inch (2.5 to 5cm) gap between the stringboard and the tip of the rod at both sides of the staircase.

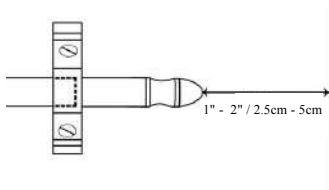

## Cleaning

- We recommend using a damp cloth to keep the rods clean, any household cleaners used to clean the wood and paint work of the staircase should be applied to the cloth and not directly onto the surface of the stair, as over spray can cause a speckled tarnish on the rods. If any liquids are inadvertently spilt on the stair rods they should be cleaned immediately with a damp cloth and dried with a clean cloth.

# Victorian Stair Clips



- Available in Polished Brass, Satin Brass, Antique Brass, Chrome, Satin Nickel, Black, Brushed Chrome, Pewter, Polished Nickel and Bronze.
- Sold in pairs.

## Victorian Stair Clip Prices

Available in Polished Brass, Satin Brass, Antique Brass, Chrome, Satin Nickel, Black, Brushed Chrome, Pewter, Polished Nickel and Bronze.

Per Pair

£7.95

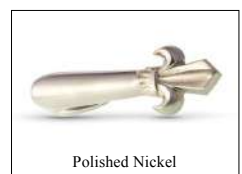
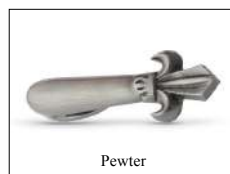
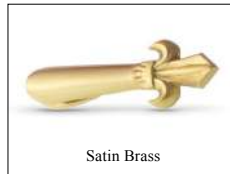



## **Product**

- The Victorian Stair Clip for runner carpets only.
- The Victorian Stair Clip Range are sold as a pair.

## **Prepare Hinge Brackets For fitting**

- The Victorian Stair Clip fixing plate needs to be pivoted at 90 degrees to the main body of the clip. This gives access to the screw holes.



ANY QUESTIONS  
Please call 01207 591176 For friendly expert advice.

## **Fitting Rods To Stair.**

- Fitting the Victorian Stair Clip is easier if done before fitting the carpet.
- First mark the width of the carpet where the tread meets the riser, use this mark to line up the inner edge of the fixing plate with where the edge of the carpet will be.
- Next measure the height of the carpet and underlay, this will give you a guide to ensure you fit the Victorian Stair Clip level.
- Now line the bottom surface of the Clip with the carpet height mark and have the fixing plate perfectly level. Mark with a pencil around the fixing plate.
- Pivot the fixing plate and line it up with the pencil mark and mark the holes.
- You can now make a template using the hole positions and carpet width and height marks to give the position of the hole on the remaining stairs.
- Victorian Stair Clips are supplied with number 6 screws and you must drill a pilot hole before fixing the brackets to the stair. For softwood create a 2.5mm pilot hole and for hardwood create a 3mm hole. Remember to set your power drill on a low torque setting to avoid breaking the screws.



## **Care and Maintenance**

- We recommend using a damp cloth to keep the rods clean, any household cleaners used to clean the wood and paint work of the staircase should be applied to the cloth and not directly onto the surface of the stair, as over spray can cause a speckled tarnish on the rods. If any liquids are inadvertently spilt on the stair rods they should be cleaned immediately with a damp cloth and dried with a clean cloth.



- Available in: Polished Brass, Antique Brass, Satin Brass, Bronze, Chrome, Brushed Chrome, Satin Nickel, Polished Nickel, Pewter and Black.
- Minimum order of 6 in any combination.

## Skiffer Prices

<b>75mm</b>	£5.20 each
<b>107mm</b>	£5.74 each
<b>134mm</b>	£6.58 each



Carriage paid on 6 and over. Less than 6, add £7.50 for carriage, unless ordered with other items.



- Features a specially designed 19mm serrated stud to fix through even the thickest of carpets.
- Available in: Brass, Bronze, Chrome, Satin Nickel and Black/Pewter.

## Easystud Prices

Available in Brass, Bronze, Chrome, Satin Nickel, and Black/Pewter,

1 Jar (100 approx)	£11.94
1 Jar (250 approx)	£29.83

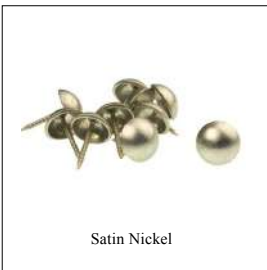
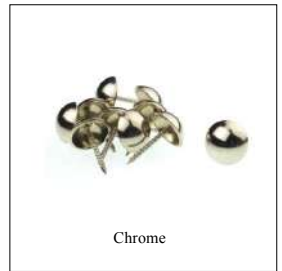
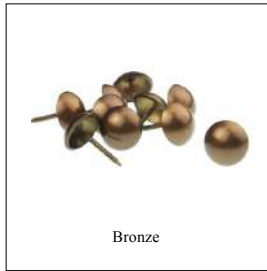
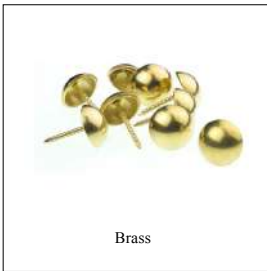

Carriage paid on 200 and over. Less than 200, add £7.50 for carriage, unless ordered with other items.

# Decorative Pipe Covers



- A selection of attractive metal radiator pipe covers in various designs and colours.
- Available in: Brass, Antique, Bronze, Chrome, Satin Nickel, Pewter and Black.

## Decorative Pipe Cover Prices

Profile Type	1 +	16 +	50 +
Small Deco Pipe Covers	£4.56 Each	£2.56 Each	£2.30 Each
Large Deco Pipe Covers	£5.29 Each	£3.29 Each	£2.96 Each

Circulus



Quadratum



Solis



Oblongo



Flos

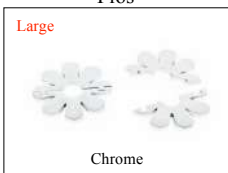

Cordis

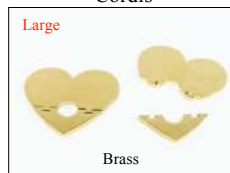

Stella

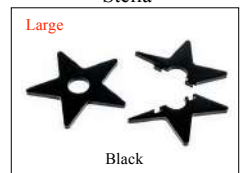

Carriage paid on 16 and over. Less than 16, add £7.50 for carriage, unless ordered with other items.



## **Product**

- The Decorative Radiator Pipe Covers use a base material of zinc alloy for a high-quality installation.

## **Fitting**

- Simply slots together and loose laid.
- Fits a 15mm radiator pipe.

	Minimum Clearance Needed	Maximum Expansion Hole
<b>Cordis</b>	45mm	36mm
<b>Solis</b>	24mm	36mm
<b>Oblongo</b>	31mm	40mm
<b>Flos</b>	25mm	30mm
<b>Quadratum</b>	14mm	42mm
<b>Stella</b>	32mm	32mm
<b>Circulus</b>	14mm	40mm

Minimum Clearance Needed

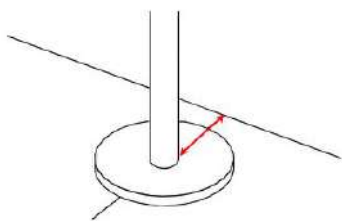

Maximum Expansion Hole

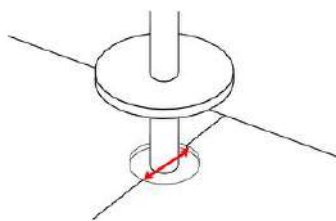



- Fixing your height differences
- Each shim is 36" (91.5cm) wide with an 8" (20cm) ramp.

## Easyshim Prices

	6mm (nominal)	9mm (nominal)	12mm (nominal)	15mm (nominal)
1 pack (10 shims)	£42.68	£46.24	£53.41	£60.58
5 pack (50 shims)	£28.36	£31.91	£39.07	£46.22
10 pack (100 shims)	£25.49	£28.62	£35.08	£41.52

5 and 10 pack prices can be in any combination of shims e.g. 1 pack of 6mm, 1 pack of 9mm, 2 pack of 12mm, 1 pack of 15mm, or 5 packs of 9mm.

**Single shims can be purchased when ordering with Premier Trims.**

## Easyshim Starter Pack Price

Easyshim Starter Pack contains the following: This is sufficient for 8 door ways.  
Easyshims 2 x 6mm, 2 x 9mm, 2 x 12mm and 2 x 15mm.

£54.46

## Height Difference Rough Guide Carpet to Hard Floor

Base Floor to High Hard Floor = Height Difference (HD) rough guide for DoubleZ™<sup>9</sup> using shims, chocks & underlay

(HD)	Shim	Chock	Base	Gap	Nap	Equals (HD)
16mm	6mm	+ 3mm	+ 1mm	+ 9mm	- 3mm	= 16mm
19mm	9mm	+ 3mm	+ 1mm	+ 9mm	- 3mm	= 19mm
22mm	12mm	+ 3mm	+ 1mm	+ 9mm	- 3mm	= 22mm
25mm	15mm	+ 3mm	+ 1mm	+ 9mm	- 3mm	= 25mm

**A PDF on how to make Side Shims is available for download at [stairrods.co.uk](http://stairrods.co.uk) under the FAQs**



## **Product**

- The Easyshim is the perfect way to raise the level of your carpet if you encounter a height difference.
- Can accommodate up to a maximum height of 40mm.
- Use in combination with various Stairrods trims.
- Available in four options 6, 9, 12 & 15mm
- 2 corners shims can be created using single shim..

## **Installation**

- Easyshims can be either mechanically fixed or adhered with an appropriate adhesive.
- Watch our installation video at [www.stairrods.co.uk](http://www.stairrods.co.uk) for more information.



ANY QUESTIONS  
Please call 01207 591176 For friendly expert advice.

## **See some installation examples below**

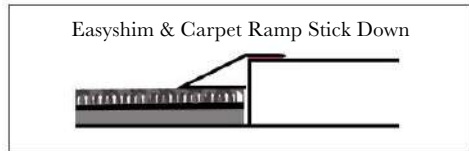
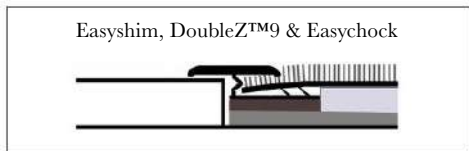
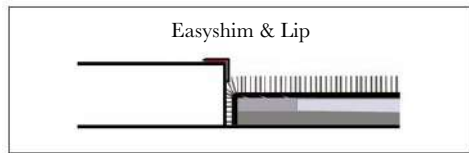
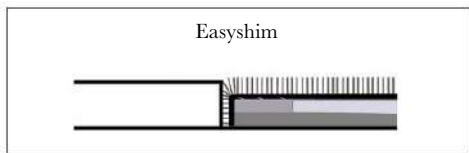



- Used to raise the profile for stretch fit installations.
- Raising the base allows for optimal teeth penetration.
- Easywedge's used to raise the back edge of Singles, Square Edge's etc.

## Easychocks & Easywedges Prices

A convenient 'Raised Base' for our DoubleZ™, Z Trim, Slim Z, Square and Single.

	1 Bucket	10 + Buckets
Easychock Bucket (approx 250)	£8.00	£7.11 each
Easywedge Bucket (approx 250)	£6.00	£5.33 each
Easychock Bucket (approx 1000)	£30.00	£28.00 each
Easywedge Bucket (approx 1000)	£22.00	£20.00 each

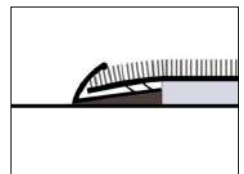
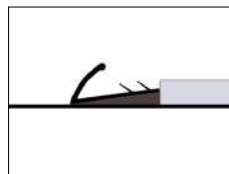
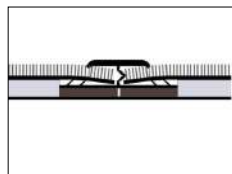
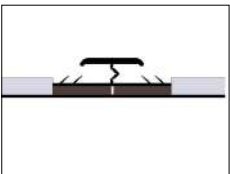



## **Product**

- For use when installing carpet using the stretch fit method.
- Both products are 3mm in thickness, raising the 1mm profile bases up to 4mm.
- The MDF Spacers or Easywedges are supplied with every order of Double Z, Slim Z, Ali Tramline Z, Square and Single profiles.
- Easywedges and Easychocks are also available for purchase in buckets of 250 or 1000.



## **Installation**

- Cut down the spacer and place under nail holes to achieve a raised base of 4mm.
- By placing a wedge under each nail hole the profile will raise the back pins up to 4mm, whilst still keeping the leading edge of the profile flush to the floor.
- Easy Wedges can also be used to accommodate various heights when using the Ali Tramline Z, by placing a wedge under the anchoring pins the front edge will lower.



ANY QUESTIONS  
Please call 01207 591176 For friendly expert advice.

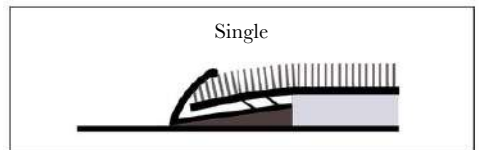
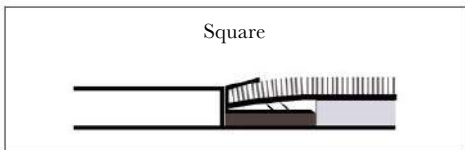
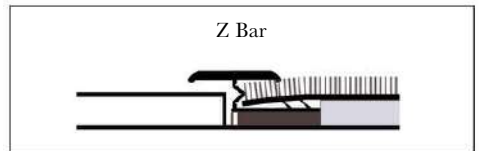
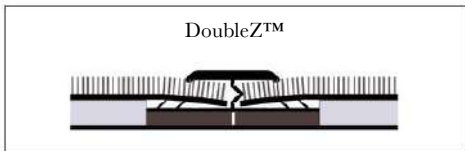



- The Double Z 4 is a Double naplock and Z profile in one.
- Designed for stick down products up to 4mm in thickness.
- Supplied with MDF Spacer for use in combination with an underlay system.

**Free MDF Strips Supplied**

## DoubleZ™4 Prices

		Individual Price		50 Price (Any Trims)	
Profile Type	Size	Standard	Specialised	Standard	Specialised
	90cm	£15.99	£23.32	£14.39	£20.41
	180cm	£31.98	£46.44	£28.78	£40.82
	270cm	£47.97	£69.66	£43.17	£61.23

**Single shims can be purchased when ordering with DoubleZ™4.**



Sp



Sp



Sp



Sp



Sp



Sp

**Carriage paid on 3 and over. Less than 3, add £7.50 for carriage, unless ordered with other items.**



## **Product**

- Base material high grade aluminium with a solid brass cap.
- Z Bar option will accommodate up to 12mm expansion.

## **Installation**

- For use with 4mm thick carpets i.e. Flatweave, thin Sisal carpets etc.
- Can be used during direct stick/double stick installations.
- The Double Z 4 is designed to nap down, clamping the carpet in place.
- The use of an adhesive bead can be used to help secure the carpet.
- Use the MDF Spacer cut into short lengths to raise base when used in conjunction with an underlay system.
- To create a Z bar score along the peel line with a utility knife and peel away with a pair of pliers..

ANY QUESTIONS  
Please call 01207 591176 For friendly expert advice.

## **See some installation examples below**

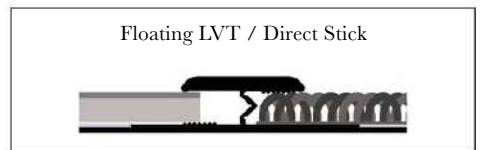
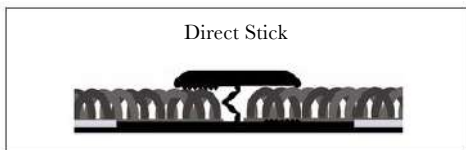

**Cleaning Guide, See page 105**



- The Double Z 9 is a Double naplock and Z bar in one.
- Supplied with MDF Spacer for use in combination with an underlay system.

**Free MDF Strips  
Supplied**

## DoubleZ™9 Prices

		Individual Price		50 Price (Any Trims)	
Profile Type	Size	Standard	Specialised	Standard	Specialised
	90cm	£16.50	£23.83	£14.85	£20.85
	180cm	£33.00	£47.66	£29.70	£41.70
	270cm	£49.40	£71.49	£44.55	£62.55

**Single shims can be purchased when ordering with DoubleZ™9.**

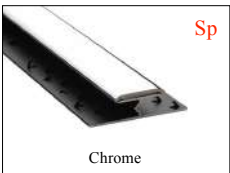

**Carriage paid on 3 and over. Less than 3, add £7.50 for carriage, unless ordered with other items.**



## **Product**

- Base material high grade aluminium with a solid brass cap.
- Z Bar option will accommodate up to 12mm expansion.

## **Installation**

- For use with stretch fit carpets and direct stick/ double stick installations.
- The Double Z 9 is designed to nap down, clamping the carpet onto the anchoring pins.
- Use the MDF Spacer cut into short lengths to raise base when used in conjunction with an underlay system.
- To create a Z bar score along the peel line with a utility knife and peel away with a pair of pliers.
- **Watch our installation video at [www.stairrods.co.uk](http://www.stairrods.co.uk) for more information.**



ANY QUESTIONS  
Please call 01207 591176 For friendly expert advice.

## **See some installation examples below**

Underlay raising base with 3mm MDF



As a Z Bar with 3mm MDF, Pre 'nap'



**Cleaning Guide, See page 105**



- The Double Z 13 is a Double naplock and Z bar in one.
- Supplied with MDF Spacer for use in combination with an underlay system.
- The Double Z 13 is for use with thicker high-density pile carpets NOT higher hard floors

**Free MDF Strips  
Supplied**

## DoubleZ™13 Prices

		Individual Price		50 Price (Any Trims)	
Profile Type	Size	Standard	Specialised	Standard	Specialised
	90cm	£18.00	£25.33	£16.20	£22.80
	180cm	£36.00	£50.66	£32.40	£45.60
	270cm	£50.40	£75.99	£48.60	£68.40

**Single shims can be purchased when ordering with DoubleZ™13.**

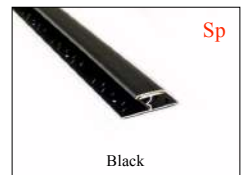
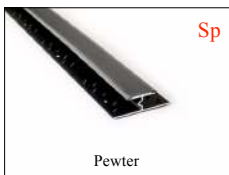
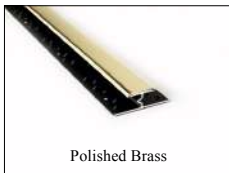

**Carriage paid on 3 and over. Less than 3, add £7.50 for carriage, unless ordered with other items.**



## **Product**

- Base material high grade aluminium with a solid brass cap.
- Z Bar option will accommodate up to 12mm expansion
- The Double Z 13 is for use with thicker high-density pile carpets NOT higher hard floors.

## **Installation**

- For use with stretch fit carpets and direct stick /double stick installations.
- The Double Z 13 is designed to nap down, clamping the carpet onto the anchoring pins.
- Use the MDF Spacer cut into short lengths to raise base when used in conjunction with an underlay system.
- To create a Z bar score along the peel line with a utility knife and peel away with a pair of pliers.
- **Watch our installation video at [www.stairrods.co.uk](http://www.stairrods.co.uk) for more information.**



ANY QUESTIONS  
Please call 01207 591176 For friendly expert advice.

## **See some installation examples below**

Underlay raising base with 3mm MDF



As a Z Bar with 3mm MDF, Pre 'nap'



**Cleaning Guide, See page 105**

# Premier Slim D



- The Slim D is an innovative design utilising gripper to install.
- Discreet 16mm top.

## Slim D Prices

Profile Type		Individual Price		50 Price (Any Trims)	
		Standard	Specialised	Standard	Specialised
	90cm	£13.27	£16.46	£11.94	£14.81
	180cm	£26.54	£32.92	£23.88	£29.62
	270cm	£39.81	£49.38	£35.82	£44.43

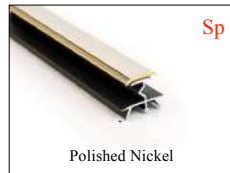

Carriage paid on 3 and over. Less than 3, add £7.50 for carriage, unless ordered with other items.



## **Product**

- Base material high grade aluminium with a solid brass cap.
- For use with carpets up to a maximum thickness of 12mm.

## **Installation**

- Innovative design utilises the Gripper to install the profile and anchor the carpet in position for a superior hold..
- The use of an adhesive bead with the profile leg can be used to provide an additional hold.
- Designed to be napped down, clamping the carpet onto the anchoring pins.
- Apply a bead of adhesive into the gully prior to placing the carpet for added security.
- **Watch our installation video at [www.stairrods.co.uk](http://www.stairrods.co.uk) for more information.**

ANY QUESTIONS  
Please call 01207 591176 For friendly expert advice.

**See an installation example below**

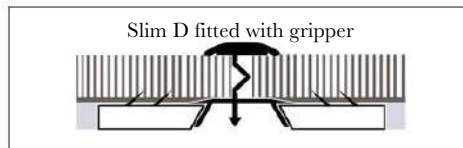

**Cleaning Guide, See page 105**



- The Slim Z is for use with carpet to hard flooring requiring no expansion.
- Discreet 22mm top.

## Slim Z Prices

		Individual Price		50 Price (Any Trims)	
Profile Type	Size	Standard	Specialised	Standard	Specialised
	90cm	£15.33	£18.40	£13.80	£16.56
	180cm	£30.66	£36.80	£27.60	£33.12
	270cm	£45.99	£55.20	£41.40	£49.68

Single shims can be purchased when ordering with Slim Z.



Carriage paid on 3 and over. Less than 3, add £7.50 for carriage, unless ordered with other items.



# Technical

42

## **Product**

- Base material high grade aluminium with a solid brass cap.

## **Installation**

- For use with stretch fit carpets and direct stick/ double stick installations.
- The Slim Z is designed to nap down, clamping the carpet onto the anchoring pins.
- Use the MDF Spacer cut into short lengths to raise base when used in conjunction with an underlay system.
- **Watch our installation video at [www.stairrods.co.uk](http://www.stairrods.co.uk) for more information.**

ANY QUESTIONS  
Please call 01207 591176 For friendly expert advice.

**See an installation example below**

Underlay raising the base with 3mm MDF



**Cleaning Guide, See page 105**



- The Single 4 is an attractive and durable finishing profile.
- Designed for stick down products up to 4mm in thickness.
- Supplied with Easywedges.

**Free Easywedges  
Supplied**

## Single 4 Prices

Profile Type	Size	Individual Price		50 Price (Any Trims)	
		Standard	Specialised	Standard	Specialised
	90cm	£12.24	£19.60	£11.02	£17.15
	180cm	£24.48	£39.20	£22.04	£34.30
	270cm	£36.72	£58.80	£33.06	£51.45



**Carriage paid on 3 and over. Less than 3, add £7.50 for carriage, unless ordered with other items.**



## **Product**

- Base material high quality brass.

## **Installation**

- For use with 4mm thick carpets i.e. Flatweave, thin Sisal carpets etc..
- Can be used during direct stick/double stick installations.
- The Single 4 is designed to nap down, clamping the carpet in place.
- The use of an adhesive bead can be used to help secure the carpet.
- Use the Easywedges to raise base when used in conjunction with an underlay system.
- **Watch our installation video at [www.stairrods.co.uk](http://www.stairrods.co.uk) for more information.**

ANY QUESTIONS  
Please call 01207 591176 For friendly expert advice.

## **See some installation examples below**

Fully adhered



Double stick underlay with Easywedges



**Cleaning Guide, See page 105**



- The Single 9 is an attractive and durable finishing profile.
- Supplied with Easywedges.

**Free Easywedges  
Supplied**

## Single 9 Prices

Profile Type	Size	Individual Price		50 Price (Any Trims)	
		Standard	Specialised	Standard	Specialised
	90cm	£12.75	£20.11	£11.48	£17.60
	180cm	£25.50	£40.22	£22.96	£35.20
	270cm	£38.25	£60.33	£34.44	£52.80

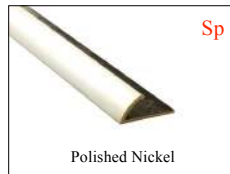

**Carriage paid on 3 and over. Less than 3, add £7.50 for carriage, unless ordered with other items.**



# Technical

46

## **Product**

- Base material high quality brass

## **Installation**

- For use with medium pile stretch fit carpets and direct stick/ double stick installations.
- The Single 9 is designed to nap down, clamping the carpet onto the anchoring pins.
- Use the Easywedges to raise base when used in conjunction with an underlay system.
- **Watch our installation video at [www.stairrods.co.uk](http://www.stairrods.co.uk) for more information.**

ANY QUESTIONS  
Please call 01207 591176 For friendly expert advice.

**See an installation example below**

Underlay with Easywedges.



**Cleaning Guide, See page 105**



- The Single 13 is an attractive and durable finishing profile.
- Supplied with Easywedges.
- Designed to be used with thicker/ high density pile carpets.

**Free Easywedges  
Supplied**

## Single 13 Prices

Profile Type	Size	Individual Price		50 Price (Any Trims)	
		Standard	Specialised	Standard	Specialised
	90cm	£16.75	£24.11	£15.08	£21.70
	180cm	£33.50	£48.22	£30.16	£43.40
	270cm	£50.25	£72.33	£45.24	£65.10

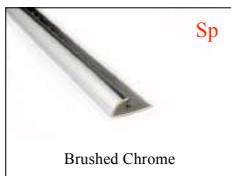

**Carriage paid on 3 and over. Less than 3, add £7.50 for carriage, unless ordered with other items.**



## **Product**

- Base material high quality brass.

## **Installation**

- For use with thicker/ high density pile stretch fit carpets and direct stick/ double stick installations.
- The Single 13 is designed to nap down, clamping the carpet onto the anchoring pins.
- Use the Easywedges to raise base when used in conjunction with an underlay system.
- **Watch our installation video at [www.stairrods.co.uk](http://www.stairrods.co.uk) for more information.**

ANY QUESTIONS  
Please call 01207 591176 For friendly expert advice.

**See an installation example below**

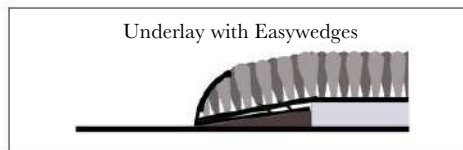

**Cleaning Guide, See page 105**

# Premier Square



- The Square Edge is an attractive and durable finishing profile.
- Supplied with Easywedges.

**Free MDF strips  
Supplied**

## Square Prices

Profile Type	Size	Individual Price		50 Price (Any Trims)	
		Standard	Specialised	Standard	Specialised
	90cm	£14.25	£21.61	£12.83	£18.91
	180cm	£28.50	£43.22	£25.66	£37.82
	270cm	£42.75	£64.83	£38.49	£56.73



**Carriage paid on 3 and over. Less than 3, add £7.50 for carriage, unless ordered with other items.**



# Technical

50

## **Product**

- Base material high quality brass.

## **Installation**

- For use with medium pile stretch fit carpets and direct stick/ double stick installations.
- The Square Edge is designed to nap down, clamping the carpet onto the anchoring pins.
- Use the Easywedges to raise base when used in conjunction with an underlay system.
- **Watch our installation video at [www.stairrods.co.uk](http://www.stairrods.co.uk) for more information.**

ANY QUESTIONS  
Please call 01207 591176 For friendly expert advice.

**See some installation examples below**

Underlay raising the base with 3mm MDF



**Cleaning Guide, See page 105**



- The Premier Posh is a versatile screw down profile.
- Fixings are hidden by the matching brass inlay.
- Supplied with screws..

## Posh Prices

Profile Type	Size	Individual Price		50 Price (Any Trims)	
		Standard	Specialised	Standard	Specialised
	90cm	£15.70	£23.43	£14.13	£21.09
	180cm	£31.40	£46.86	£28.26	£42.18
	270cm	£47.10	£70.29	£42.39	£63.27
	90cm	£17.30	£25.03	£15.57	£22.53
	180cm	£34.60	£50.06	£31.14	£45.06
	270cm	£51.90	£75.09	£46.71	£67.59
	90cm	£22.54	£30.27	£20.29	£27.24
	180cm	£45.08	£60.54	£40.58	£54.48
	270cm	£67.62	£90.81	£60.87	£81.72

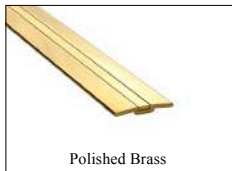

Polished Brass



Satin Brass



Antique Brass



Antique Bronze

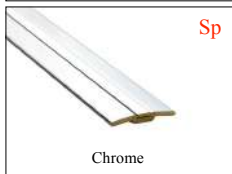

Chrome



Brushed Chrome



Polished Nickel



Satin Nickel



Pewter



Black

Carriage paid on 3 and over. Less than 3, add £7.50 for carriage, unless ordered with other items.



## **Product**

- Base material high quality brass
- Available in widths of 30, 38 & 55mm.
- Can be used with either carpet and/or hard flooring.
- The 3 widths available can accommodate various height differences
  - Posh 30 can accommodate a height difference of up to 4mm.
  - Posh 38 can accommodate a height difference of up to 6mm.
  - Posh 55 can accommodate a height difference of up to 8mm.

## **Installation**

- Supplied with fixing screws.
- Remove the inlay, affix the profile and re-insert the inlay using the pre-attached tape to secure, making sure not to bend the inlay.
- When used with hard floor to hard floor, a recess must be created to accommodate the screw gully.
- **Watch our installation video at [www.stairrods.co.uk](http://www.stairrods.co.uk) for more information.**

ANY QUESTIONS  
Please call 01207 591176 For friendly expert advice.

## **See some installation examples below**

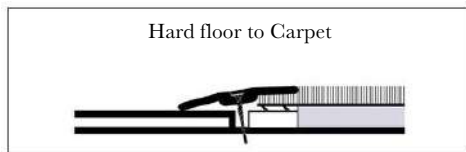
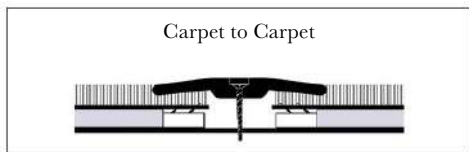

**Cleaning Guide, See page 105**



- The Premier Cover is a classic, timeless finishing profile.
- Supplied with matching-coloured screws.

## Cover Prices

Profile Type	Size	Individual Price		50 Price (Any Trims)	
		Standard	Specialised	Standard	Specialised
 30mm	90cm	£13.57	£17.20	£12.21	£15.48
	180cm	£27.14	£34.40	£24.42	£30.96
	270cm	£40.71	£51.60	£36.63	£46.44
 38mm	90cm	£15.23	£22.95	£13.71	£20.66
	180cm	£30.46	£45.90	£27.42	£41.32
	270cm	£45.69	£68.85	£41.13	£61.98
 55mm	90cm	£20.28	£27.97	£18.25	£25.17
	180cm	£40.56	£55.94	£36.50	£50.34
	270cm	£60.84	£83.91	£54.75	£75.51

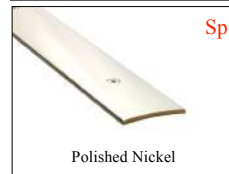
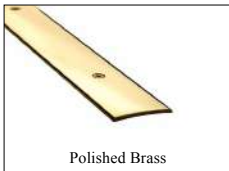

Carriage paid on 3 and over. Less than 3, add £7.50 for carriage, unless ordered with other items.



## **Product**

- Base material high quality brass.
- Available in widths of 30, 38 & 55mm.
- Can be used with either carpet and/or hard flooring
- The 3 widths available can accommodate various height differences.
  - Cover 30 can accommodate a height difference of up to 4mm.
  - Cover 38 can accommodate a height difference of up to 6mm.
  - Cover 55 can accommodate a height difference of up to 8mm.

## **Installation**

- Supplied with colour co-ordinated number 8 screws.
- Cut profile to size, install flooring then affix profile to subfloor.
- **Watch our installation video at [www.stairrods.co.uk](http://www.stairrods.co.uk) for more information.**

ANY QUESTIONS  
Please call 01207 591176 For friendly expert advice.

## **See some installation examples below**

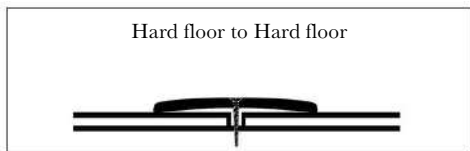
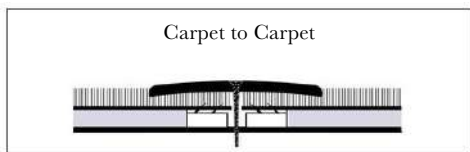

**Cleaning Guide, See page 105**

# Premier Floating Cover



- High quality brass stick down cover profile for floating & non-floating floors.
- 4 width options available dependant on expansion gap required.

## Floating Cover Prices

Profile Size	Length	Individual Price		50 Price (Any Trims)	
		Standard	Specialised	Standard	Specialised
20mm	90cm -180cm - 270cm	£8.02 - £16.04 - £24.06	£11.52 - £23.04 - £34.56	£7.22 - £14.44 - £21.66	£10.37 - £20.74 - £31.11
30mm	90cm -180cm - 270cm	£9.17 - £18.34 - £27.51	£12.64 - £25.28 - £37.92	£8.25 - £16.50 - £24.75	£11.38 - £22.76 - £34.14
40mm	90cm -180cm - 270cm	£12.08 - £24.16 - £36.24	£15.54 - £31.08 - £46.62	£10.87 - £21.74 - £32.61	£13.99 - £27.98 - £41.97
50mm	90cm -180cm - 270cm	£13.86 - £27.72 - £41.58	£17.33 - £34.66 - £51.99	£12.47 - £24.94 - £37.41	£15.60 - £31.20 - £46.80

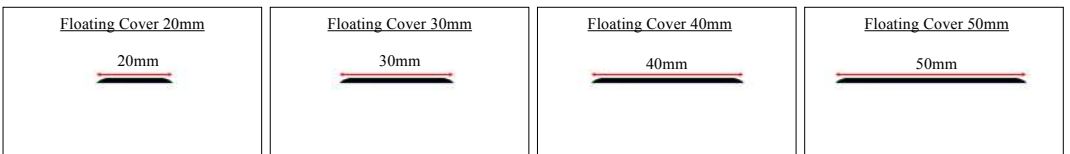

Carriage paid on 5 and over. Less than 5, add £7.50 for carriage, unless ordered with other items.



## **Product**

- Base material high quality brass.
- Supplied with pre-attached heat and moisture resistant tape.
- Profile expansion tolerances:
  - 20mm profile allows up to 10mm expansion maximum.
  - 30mm profile allows up to 20mm expansion maximum.
  - 40mm profile allows up to 30mm expansion maximum.
  - 50mm profile allows up to 40mm expansion maximum.

## **Installation**

- Designed for non-porous, level floating flooring.
- Clean/ degrease the surface.
- Allow for correct expansion required (refer to flooring manufacturer for specific expansion requirements).
- Remove the fixing tape protective backing from one side only.
- Use one row of tape to adhere to the surface with least expansion resistance.
- Suitable for use with underfloor heating.
- [Watch our installation video at www.stairrods.co.uk](http://www.stairrods.co.uk) for more information..

ANY QUESTIONS  
Please call 01207 591176 For friendly expert advice.

## **See some installation examples below**

20mm allows maximum of 10mm expansion



30mm allows maximum of 20mm expansion



40mm allows maximum of 30mm expansion



50mm allows maximum of 40mm expansion

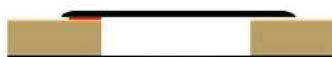

**Cleaning Guide, See page 105**



- Attractive solid brass stick down profile, 2 options available.
- For use where one floor is 1 – 2mm higher.

## Floating Vinyl Edge Prices

Profile Type	Size	Individual Price		50 Price (Any Trims)	
		Standard	Specialised	Standard	Specialised
<b>Floating Vinyl Edge 1mm</b> 	90cm	£8.58	£12.08	£7.72	£10.87
	180cm	£17.16	£24.16	£15.44	£21.74
	270cm	£25.74	£36.24	£23.16	£32.61
<b>Floating Vinyl Edge 2mm</b> 	90cm	£9.10	£12.60	£8.19	£11.34
	180cm	£18.20	£25.20	£16.38	£22.68
	270cm	£27.30	£37.80	£24.57	£34.02

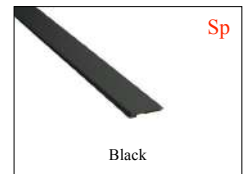
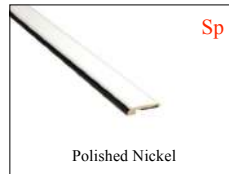
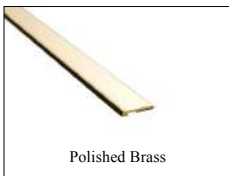

Carriage paid on 5 and over. Less than 5, add £7.50 for carriage, unless ordered with other items.



# Technical



58

## **Product**

- Base material high quality brass.
- Supplied with pre-attached heat and moisture resistant adhesive tape.
- Designed for use with non-porous hard flooring.
- Designed to accommodate a height difference where a floor is lower on one side.
- 2 options available:
  - 1mm drop.
  - 2mm drop.

## **Installation**

- Designed for non-porous, level floating and non-floating hard flooring.
- Clean/ degrease the surface.
- Allow for correct expansion if required (refer to flooring manufacturer for specific expansion requirements).
- Remove the fixing tape protective backing and place firmly in position.
- Suitable for use with underfloor heating.
- **Watch our installation video at [www.stairrods.co.uk](http://www.stairrods.co.uk) for more information.**

ANY QUESTIONS  
Please call 01207 591176 For friendly expert advice.

Get your Drop Checker



Ask your Stairrods UK Sales Representative.

**See some installation examples below**

1mm Floating Vinyl Edge



2mm Floating Vinyl Edge



**Cleaning Guide, See page 105**

# Premier TwoWay Ramp 2-3mm, 4-5mm, 6-7mm & 8-9mm

59



- Attractive solid brass ramp profile..
- Innovative design accommodates height differences between 2 – 9mm.

## Two-Way Ramp Prices

Profile Size	Length	Individual Price			50 Price (Any Trims)	
		Standard	Specialised		Standard	Specialised
2-3mm	90cm / 180cm / 270cm	£9.49 / £18.98 / £28.47	£12.99 / £25.98 / £38.97		£8.51 / £17.02 / £25.53	£11.69 / £23.38 / £35.07
4-5mm	90cm / 180cm / 270cm	£10.12 / £20.24 / £30.36	£13.62 / £27.24 / £40.86		£9.11 / £18.22 / £27.33	£12.26 / £24.52 / £36.78
6-7mm	90cm / 180cm / 270cm	£11.03 / £22.06 / £33.09	£14.53 / £29.06 / £43.59		£9.93 / £19.86 / £29.79	£13.08 / £26.16 / £39.24
8-9mm	90cm / 180cm / 270cm	£12.22 / £24.44 / £36.66	£15.72 / £31.44 / £47.16		£11.00 / £22.00 / £33.00	£14.15 / £28.30 / £42.45

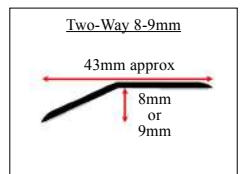
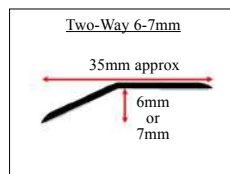
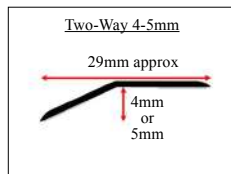
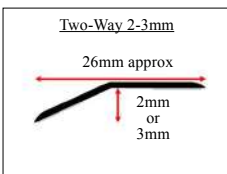
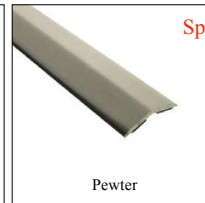
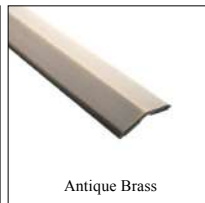

Carriage paid on 5 and over. Less than 5, add £7.50 for carriage, unless ordered with other items.



## **Product**

- Base material high quality brass.
- Can be used with floating and non-floating hard floors.
- Supplied with a pre-attached heat and moisture resistant adhesive tape.
- Suitable for use with under floor heating.
- An innovative design allows one profile to accommodate two height differences, by turning the profile the height can be adjusted by 1mm.
  - 26mm wide allows 2 – 3mm drop.
  - 29mm wide allows 4 – 5mm drop.
  - 35mm wide allows 6 – 7mm drop.
  - 43mm wide allows 8 – 9mm drop.

## **Installation**

- Designed for non-porous, level floating and non-floating hard flooring.
- Clean/ degrease the surface.
- Check depth and use correct profile to accommodate drop.
- Allow for correct expansion if required (refer to flooring manufacturer for specific expansion requirements).
- Remove the fixing tape protective backing and place firmly in position.
- Suitable for use with underfloor heating.
- **Watch our installation video at [www.stairrods.co.uk](http://www.stairrods.co.uk) for more information.**

ANY QUESTIONS  
Please call 01207 591176 For friendly expert advice.

Get your Drop Checker



Ask your Stairrods UK Sales Representative.

## **See some installation examples below**

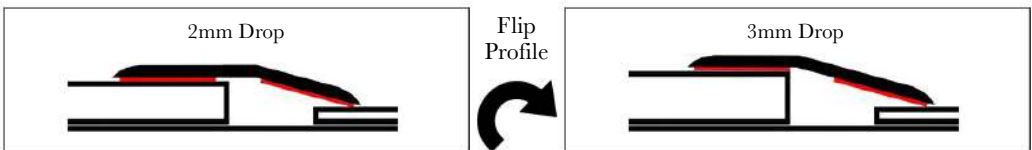

**Cleaning Guide, See page 112**

# Premier Ramp 10, 12, 14, 16 & 20mm



- Attractive solid brass ramp profile.
- Five height options available 10, 12, 14, 16 & 20mm.

## Ramp Prices

Profile Size	Length	Individual Price		50 Price (Any Trims)	
		Standard	Specialised	Standard	Specialised
10mm	90cm / 180cm / 270cm	£10.40 / £20.80 / £31.20	£13.90 / £27.80 / £41.70	£9.36 / £18.72 / £28.08	£12.51 / £25.02 / £37.53
12mm	90cm / 180cm / 270cm	£11.06 / £22.12 / £33.18	£14.56 / £29.12 / £43.68	£9.95 / £19.90 / £29.85	£13.10 / £26.20 / £39.30
14mm	90cm / 180cm / 270cm	£12.60 / £25.20 / £37.80	£17.01 / £34.02 / £51.03	£11.34 / £22.68 / £34.02	£15.31 / £30.62 / £45.93
16mm	90cm / 180cm / 270cm	£13.27 / £26.54 / £39.81	£17.71 / £35.42 / £53.13	£11.94 / £23.88 / £35.82	£15.94 / £31.88 / £47.82
20mm	90cm / 180cm / 270cm	£14.46 / £28.92 / £43.38	£19.00 / £38.00 / £57.00	£13.01 / £26.02 / £39.03	£17.10 / £34.20 / £51.30

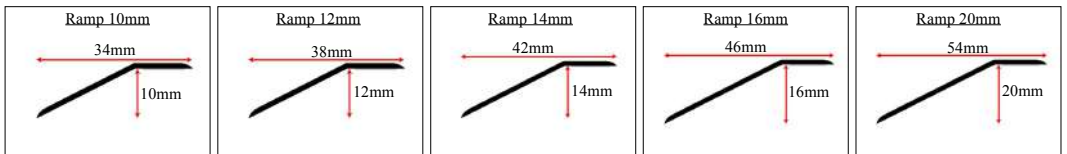

Carriage paid on 5 and over. Less than 5, add £7.50 for carriage, unless ordered with other items.



# Technical



62

## **Product**

- Base material high quality brass.
- Can be used with floating and non-floating hard floors.
- Supplied with a pre-attached heat and moisture resistant adhesive tape.
- Suitable for use with under floor heating.
- Height options:
  - 34mm ramp accommodates 10mm drop.
  - 38mm ramp accommodates 12mm drop.
  - 42mm ramp accommodates 14mm drop.
  - 46mm ramp accommodates 16mm drop.
  - 54mm ramp accommodates 20mm drop.

## **Installation**

- Designed for non-porous, level floating and non-floating hard flooring.
- Clean/ degrease the surface.
- Check depth and use correct profile to accommodate drop.
- Allow for correct expansion if required (refer to flooring manufacturer for specific expansion requirements).
- Remove the fixing tape protective backing and place firmly in position.
- **Watch our installation video at [www.stairrods.co.uk](http://www.stairrods.co.uk) for more information.**

ANY QUESTIONS  
Please call 01207 591176 For friendly expert advice.

Get your Drop Checker



Ask your Stairrods UK Sales Representative.

**See an installation example below**

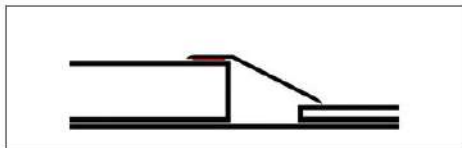

**Cleaning Guide, See page 105**

# Premier Carpet Ramp



- Attractive solid brass ramp profile.
- Designed to accommodate excessive height differences between carpet and hard floors.

## Carpet Ramp Prices

Profile Type	Size	Individual Price		50 Price (Any Trims)	
		Standard	Specialised	Standard	Specialised
<b>Carpet Ramp 5mm</b> 	<b>90cm</b>	£11.90	£15.40	£10.71	£13.86
	<b>180cm</b>	£23.80	£30.80	£21.42	£27.72
	<b>270cm</b>	£35.70	£46.20	£32.13	£41.58

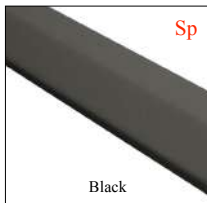
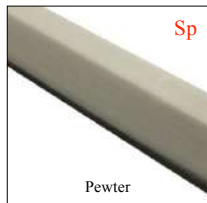
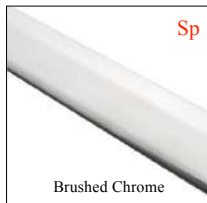
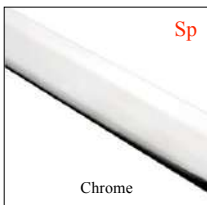
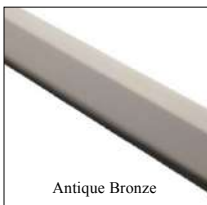
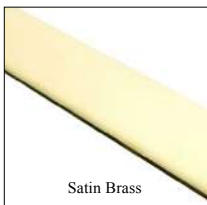
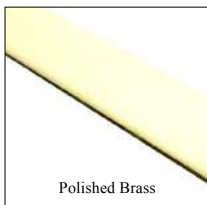

Carriage paid on 3 and over. Less than 3, add £7.50 for carriage, unless ordered with other items.



## **Product**

- Base material high quality brass.
- Can be used with floating and non-floating hard floors.
- Supplied with a pre-attached heat and moisture resistant adhesive tape.
- Suitable for use with under floor heating.
- Can accommodate heights up to a maximum of 40mm dependant on carpet thickness.
- Guide for height calculation:
  - Height 40mm - Shim 15mm + Gripper 7mm + Carpet Thickness 13mm + Carpet Ramp 5mm = 40mm.

## **Installation**

- Designed for non-porous, level floating and non-floating hard flooring.
- Clean/ degrease the surface.
- To achieve desired height use in combination with our Easyshim system.
- Remove the fixing tape protective backing and place firmly in position.
- **Watch our installation video at [www.stairrods.co.uk](http://www.stairrods.co.uk) for more information.**

ANY QUESTIONS  
Please call 01207 591176 For friendly expert advice.

Get your Drop Checker



Ask your Stairrods UK Sales Representative.

## **See some installation examples below**

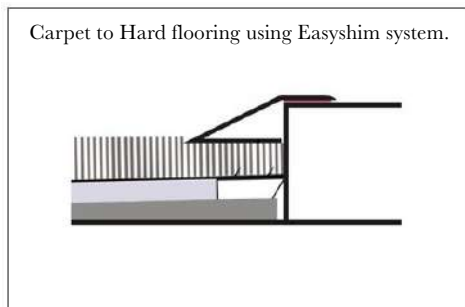
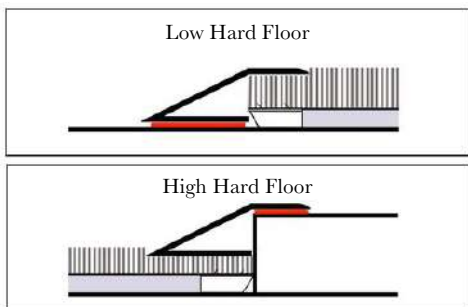

**Cleaning Guide, See page 105**



- A discreet and versatile solid brass profile which can be curved on site or fitted straight.
- For use with **non-floating** hard floors and carpets.

## Divider Prices

Profile	Size	Individual Price		50 Price (Any Trims)	
		Standard	Specialised	Standard	Specialised
D3.5	90cm / 180cm / 270cm	£9.42 / £18.84 / £28.26	£12.35 / £24.70 / £37.05	£8.47 / £16.94 / £25.41	£11.11 / £22.22 / £33.33
D4.5	90cm / 180cm / 270cm	£9.86 / £19.72 / £29.58	£12.79 / £25.58 / £38.37	£8.87 / £17.74 / £26.61	£11.51 / £23.02 / £34.53
D6.	90cm / 180cm / 270cm	£10.62 / £21.24 / £31.86	£13.55 / £27.10 / £40.65	£9.56 / £19.12 / £28.68	£12.19 / £24.38 / £36.57
D7.5	90cm / 180cm / 270cm	£9.95 / £19.90 / £29.85	£12.88 / £25.76 / £38.64	£8.96 / £17.92 / £26.88	£11.59 / £23.18 / £34.77
D9.5	90cm / 180cm / 270cm	£10.21 / £20.42 / £30.63	£13.14 / £26.28 / £39.42	£9.19 / £18.38 / £27.57	£11.82 / £23.64 / £35.46
D12	90cm / 180cm / 270cm	£10.52 / £21.04 / £31.56	£13.45 / £26.90 / £40.35	£9.45 / £18.90 / £28.35	£12.11 / £24.22 / £36.33
D14	90cm / 180cm / 270cm	£10.80 / £21.60 / £32.40	£13.73 / £27.46 / £41.19	£9.72 / £19.44 / £29.16	£12.36 / £24.72 / £37.08
D16	90cm / 180cm / 270cm	£11.06 / £22.12 / £33.18	£13.99 / £27.98 / £41.97	£9.95 / £19.90 / £29.85	£12.59 / £25.18 / £37.77
D19	90cm / 180cm / 270cm	£11.47 / £22.94 / £34.41	£14.40 / £28.80 / £43.20	£10.32 / £20.64 / £30.96	£12.96 / £25.92 / £38.88
D23	90cm / 180cm / 270cm	£12.06 / £24.12 / £36.18	£14.99 / £29.98 / £44.97	£10.86 / £21.72 / £32.58	£13.49 / £26.98 / £40.47
D25	90cm / 180cm / 270cm	£15.44 / £30.88 / £46.32	£18.36 / £36.72 / £55.08	£13.89 / £27.78 / £41.67	£16.53 / £33.06 / £49.59

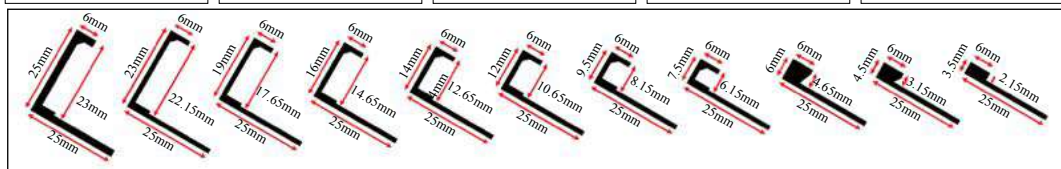
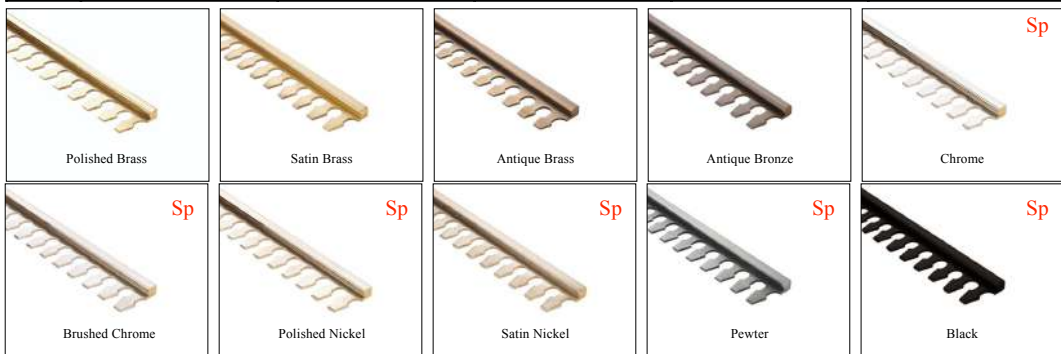

Carriage paid on 5 and over. Less than 5, add £7.50 for carriage, unless ordered with other items.



## **Product**

- Base material high quality brass..
- Versatile product which can accommodate various flooring transitions and heights including but not limited to Carpet to Hard floors.
- 11 height options available from 3.5mm – 25mm.

## **Installation**

- Pre-drilled and counter sunk at 8cm centres.
- Form curves onsite or install straight.
- For use with non-floating floors.

ANY QUESTIONS  
Please call 01207 591176 For friendly expert advice.

## **See some installation examples below**

LVT to LVT



Stick down Carpet to LVT



Stick down Carpet to Stick down Carpet



Hard Floor to Carpet



**Cleaning Guide, See page 105**



- A high end attractive and durable alternative to LVT inlays.
- 2 width options available 3.3 and 7.5mm
- Please note 2 different lengths on each Inlay

## Inlay 3.3mm Price

Profile Type	Size	Individual Price	50 Price (Any Trims)
Inlay (3.3mm Width)	100cm	£8.90	£8.01

## Inlay 7.5mm Prices

Profile Type	Size	Individual Price	50 Price (Any Trims)
Inlay (7.5mm Width)	90cm	£8.21	£7.39
	180cm	£16.42	£14.78
	270cm	£24.63	£22.17

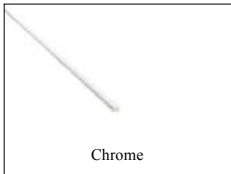

Chrome

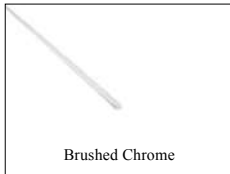

Brushed Chrome



Polished Nickel



Satin Nickel

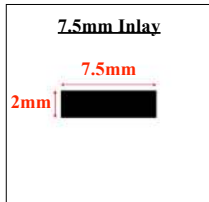
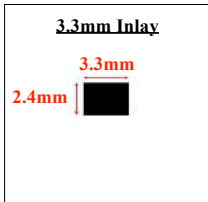

Carriage paid on 5 and over. Less than 5, add £7.50 for carriage, unless ordered with other items.



## **Product**

- The Premier Inlays use a base material of solid brass for a high-quality installation.
- Available length 3.3mm - 90cm
- Available lengths 7.5mm - 90cm, 180cm and 270cm.

## **Installation**

- The Premier Inlays are 3.3mm wide 2.4mm in depth.
- Suitable for 2.5mm and 3mm LVT dryback adhered directly to the floor.
- See our fitting video on Stairrods YouTube channel.
- The 3.3mm is difficult to curve but the 7.5mm will NOT curve.
- Use F49 adhesive.
- Use a Dremel with metal cutter blade or cutting disk to avoid chipping the chrome finish.

ANY QUESTIONS  
Please call 01207 591176 For friendly expert advice.

**Cleaning Guide, See page 105**

# Premier LVT Nosing (no bull)



- An attractive solid brass profile used for LVT on a right angle step.
- Suitable for floating and non-floating LVT flooring.
- Supplied with 2mm MDF Spacer.

## LVT Nosing (no bull) prices

Profile Type	Size	Individual Price		50 Price (Any Trims)	
		Standard	Specialised	Standard	Specialised
2.5mm	90cm	£20.03	£24.14	£18.03	£21.73
	180cm	£40.06	£48.28	£36.06	£43.46
	270cm	£60.09	£72.42	£54.09	£65.19
3mm	90cm	£20.03	£24.14	£18.03	£21.73
	180cm	£40.06	£48.28	£36.06	£43.46
	270cm	£60.09	£72.42	£54.09	£65.19
4mm	90cm	£20.03	£24.14	£18.03	£21.73
	180cm	£40.06	£48.28	£36.06	£43.46
	270cm	£60.09	£72.42	£54.09	£65.19
5mm	90cm	£20.03	£24.14	£18.03	£21.73
	180cm	£40.06	£48.28	£36.06	£43.46
	270cm	£60.09	£72.42	£54.09	£65.19

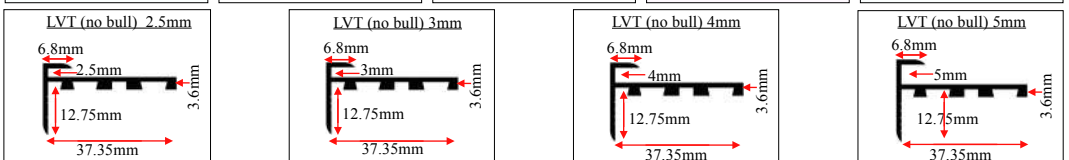

Carriage paid on 3 and over. Less than 3, add £7.50 for carriage, unless ordered with other items.



## **Product**

- Base material high quality brass..
- Designed to create a high end, durable stair nosing for LVT flooring.
- Base height 3.6mm.
- Available in 4 options 2.5, 3, 4 & 5mm dependant on flooring thickness.
- Can accommodate a maximum expansion gap of 4 – 5mm.
- Supplied with 2mm MDF spacer to accommodate 6mm Plywood tread preparation.
- If used on an overhang step the riser will need packing out.

## **Installation**

- The profile is pre-drilled and countersunk on the middle and back edge.
- Use the full length MDF Spacer to raise profile when installing flooring onto 6mm plywood.
- An adhesive can be used to provide an additional fixing.
- Stairs with an overhang requires the riser to be packed out.
- Consult flooring manufacturer regarding expansion requirements.
- **Watch our installation video at [www.stairrods.co.uk](http://www.stairrods.co.uk) for more information.**

ANY QUESTIONS  
Please call 01207 591176 For friendly expert advice.

## **See some installation examples below**

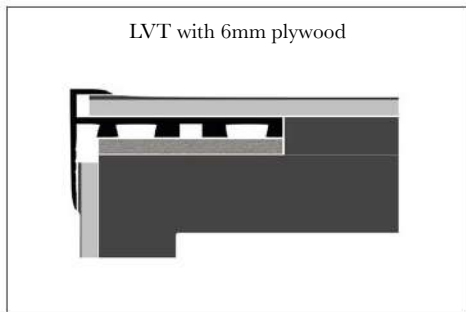
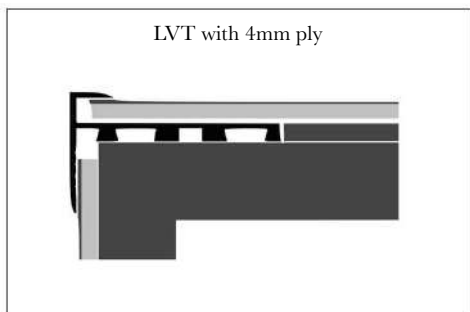

**Cleaning Guide, See page 105**

# Premier LVT Nosing (full bull)



- An attractive solid brass profile used for LVT on an overhang step.
- Suitable for floating and non-floating LVT flooring.
- Supplied with 2mm MDF Spacer.

## LVT Nosing (full bull) Prices

Profile Type	Size	Individual Price		50 Price (Any Trims)	
		Standard	Specialised	Standard	Specialised
2.5mm	90cm	£23.52	£28.56	£21.17	£25.70
	180cm	£47.04	£57.12	£42.34	£51.40
	270cm	£70.56	£85.68	£63.51	£77.10
3mm	90cm	£23.52	£28.56	£21.17	£25.70
	180cm	£47.04	£57.12	£42.34	£51.40
	270cm	£70.56	£85.68	£63.51	£77.10
4mm	90cm	£23.52	£28.56	£21.17	£25.70
	180cm	£47.04	£57.12	£42.34	£51.40
	270cm	£70.56	£85.68	£63.51	£77.10
5mm	90cm	£23.52	£28.56	£21.17	£25.70
	180cm	£47.04	£57.12	£42.34	£51.40
	270cm	£70.56	£85.68	£63.51	£77.10

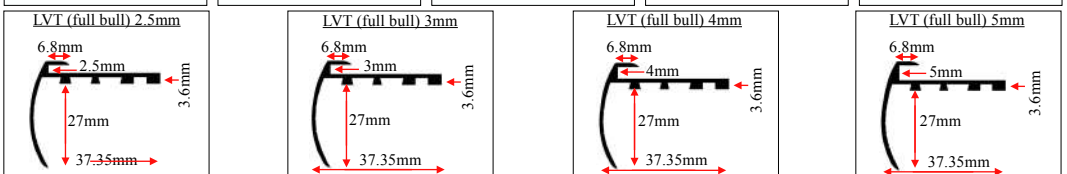

**Carriage paid on 3 and over. Less than 3, add £7.50 for carriage, unless ordered with other items.**



## **Product**

- Base material high quality brass.
- Designed to create a high end, durable stair nosing for LVT flooring.
- Base height 3.6mm.
- Available in 4 options 2.5, 3, 4 & 5mm dependant on flooring thickness.
- Can accommodate up to a maximum expansion gap of 4 – 5mm.
- Supplied with 2mm MDF spacer to accommodate 6mm Plywood tread preparation.

## **Installation**

- The full bull is pre-drilled and countersunk on the middle and back edge.
- Use the full length MDF Spacer to raise profile when installing flooring onto 6mm plywood.
- An adhesive can be used to provide an additional fixing.
- Consult flooring manufacturer regarding expansion requirements.
- **Watch our installation video at [www.stairrods.co.uk](http://www.stairrods.co.uk) for more information.**

ANY QUESTIONS  
Please call 01207 591176 For friendly expert advice.

## **See some installation examples below**

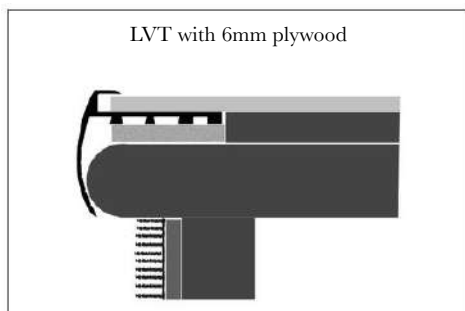
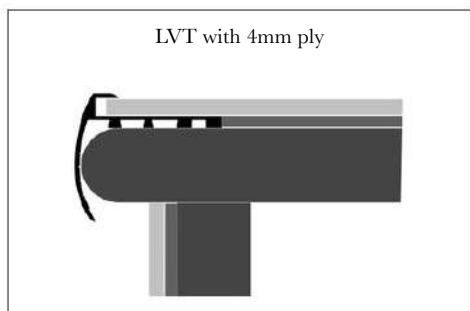

**Cleaning Guide, See page 105**

# Premier Bendybull

73



A high quality solid brass stair profile.  
Innovative design allows the curve to be formed onsite.

## Premier Bendybull Prices

Profile Type	Size	Individual Price		50 Price (Any Trims)	
		Standard	Specialised	Standard	Specialised
2.5mm	90cm	£19.06	£23.93	£17.15	£21.54
	180cm	£38.12	£47.86	£34.30	£43.08
	270cm	£57.18	£71.79	£51.45	£64.62
3mm	90cm	£19.06	£23.93	£17.15	£21.54
	180cm	£38.12	£47.86	£34.30	£43.08
	270cm	£57.18	£71.79	£51.45	£64.62
4mm	90cm	£19.06	£23.93	£17.15	£21.54
	180cm	£38.12	£47.86	£34.30	£43.08
	270cm	£57.18	£71.79	£51.45	£64.62
5mm	90cm	£19.06	£23.93	£17.15	£21.54
	180cm	£38.12	£47.86	£34.30	£43.08
	270cm	£57.18	£71.79	£51.45	£64.62

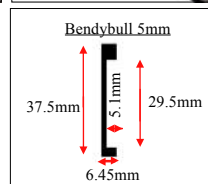
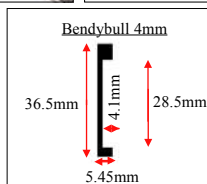
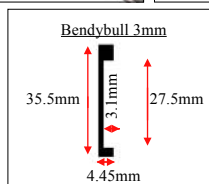
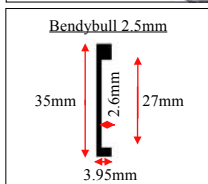

Carriage paid on 3 and over. Less than 3, add £7.50 for carriage, unless ordered with other items.



## **Product**

- Base material high quality brass.
- Innovative bend onsite finishing profile
- Available in 4 recess options 2.5, 3, 4 & 5mm dependant on flooring thickness.
- Pre-drilled and countersunk.
- Supplied with a high-grab, anti-plasticiser contact tape to secure the inlay.
- Supplied with Spax M self drilling screws (requires T20 star bit). Do NOT pre-drill.

## **Installation**

- Form a pre-bend prior to fixing.
- Mechanical primary fixing backed up by an adhesive secondary fixing.
- We recommend viewing our installation video before installing the Bendy Bull.
- **Watch our installation video at [www.stairrods.co.uk](http://www.stairrods.co.uk) for more information.**

## **See some installation examples**

Bendybull with 6mm plywood/LVT



Bendybull with WPC/SPC (no plywood)



Bends Round Bullnose (plan view)

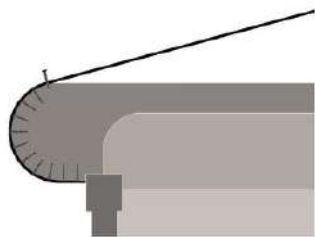

**Cleaning Guide, See page 105**



\* Various sizes and uses for adhering to non-porous floors.

## Lip Prices

Profile Size	Length	Individual Price		50 Price (Any Trims)	
		Standard	Specialised	Standard	Specialised
Lip	90cm / 180cm / 270cm	£8.34 / £16.68 / £25.02	£12.43 / £24.55 / £35.20	£7.51 / £15.02 / £22.53	£11.19 / £22.39 / £33.58
Little Lip	90cm / 180cm / 270cm	£7.70 / £15.40 / £23.10	£11.20 / £22.40 / £33.60	£6.93 / £13.86 / £20.79	£10.08 / £20.16 / £30.24
Bigger Lip	90cm / 180cm / 270cm	£10.92 / £21.84 / £32.76	£14.84 / £29.68 / £44.52	£9.83 / £19.66 / £29.49	£13.36 / £26.72 / £40.08
Wide Lip	90cm / 180cm / 270cm	£12.78 / £25.56 / £38.34	£16.70 / £33.40 / £50.10	£11.50 / £23.00 / £34.50	£15.03 / £30.06 / £45.09
Square Lip	90cm / 180cm / 270cm	£12.78 / £25.56 / £38.34	£16.70 / £33.40 / £50.10	£11.50 / £23.00 / £34.50	£15.03 / £30.06 / £45.09
Rake Back Lip	90cm / 180cm / 270cm	£10.36 / £20.72 / £31.08	£13.86 / £27.72 / £41.58	£9.32 / £18.64 / £27.96	£12.47 / £24.94 / £37.41

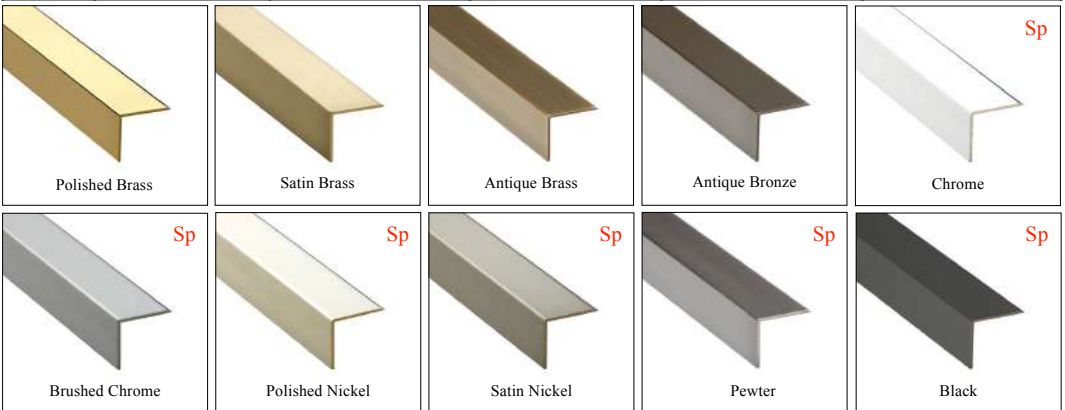

Lip	Little Lip	Wide Lip	Bigger Lip	Square Lip	Rake Back Lip
14mm	14mm	37.5mm	25mm	25mm	16mm
10.65mm	4mm	11.15mm	11.15mm	23.65mm	13.65mm

Carriage paid on 5 and over. Less than 5, add £7.50 for carriage, unless ordered with other items.



## **Product**

- Base material high quality brass.
- 3 tape options available dependant on profile usage (supplied with option 1 unless specified).
- Note: Rake Back Lip only available in tape option 1.
- Note: Little lip unavailable in tape option 2.
- Suitable for use with UFH.
- Supplied with a pre-attached heat and moisture resistant adhesive tape.
- The Rake back Lip design prevents against adhesive bleed.
- Not suitable for use as a stair nosing or in high trafficked areas..

## **Installation**

- Designed for non-porous, level hard flooring.
- Clean/ degrease the surface.
- Cut profile to desired length.
- Remove the fixing tape protective backing and place firmly in position.
- An additional bead of adhesive can be used to enhance the Rake Back Lips performance.

ANY QUESTIONS  
Please call 01207 591176 For friendly expert advice.

## **See some installation examples below**

Tape Option 1



Tape Option 2

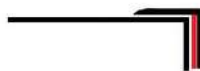

Tape Option 3

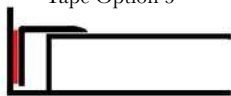

**Cleaning Guide, See page 105**



- High quality solid brass T section for ceramic tile.
- Available in 2 options, Little T and Big T.

## T Prices

Profile Type	Size	Individual Price		50 Price (Any Trims)	
		Standard	Specialised	Standard	Specialised
<b>Little T</b> 	90cm	£7.84	£11.34	£7.06	£10.21
	180cm	£15.68	£22.68	£14.12	£20.42
	270cm	£23.52	£34.02	£21.18	£30.63
<b>Big T</b> 	90cm	£10.64	£14.14	£9.58	£12.73
	180cm	£21.28	£28.28	£19.16	£25.46
	270cm	£31.92	£42.42	£28.74	£38.19

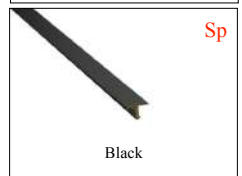

Carriage paid on 5 and over. Less than 5, add £7.50 for carriage, unless ordered with other items.



## **The Product**

- Base material high quality brass.
- Available in 2 options:
  - Little T 14mm requires a 7mm recess depth.
  - Big T 25mm requires a 10mm recess depth..

## **Installation**

- Can be installed during or post installation
- Secure into recess using an appropriate adhesive.

ANY QUESTIONS  
Please call 01207 591176 For friendly expert advice.

**See an installation example below**

Use silicone adhesive to secure Premier Ts



**Cleaning Guide, See page 105**



- An attractive solid brass edging for 12 & 17mm Matting.
- Supplied with a pre-attached heat and moisture resistant adhesive tape.

## Matwell (non floating) Prices

Profile Type	Size	Individual Price		50 Price (Any Trims)	
		Standard	Specialised	Standard	Specialised
<b>Matwell (non floating) 5mm</b> 	90cm	£10.89	£15.02	£9.80	£13.52
	180cm	£21.78	£30.04	£19.60	£27.04
	270cm	£32.67	£45.06	£29.40	£40.56
<b>Matwell (non floating) 8mm</b> 	90cm	£13.40	£17.54	£12.06	£15.79
	180cm	£26.80	£35.08	£24.12	£31.58
	270cm	£40.20	£52.62	£36.18	£47.37



Carriage paid on 5 and over. Less than 5, add £7.50 for carriage, unless ordered with other items.



## **Product**

- Base material high quality brass.
- Designed to be used with non-floating hard flooring.
- Supplied with a pre-attached heat and moisture resistant adhesive tape.
- Suitable for use with UFH.
- Available in 2 height options 5mm and 8mm.
- Maximum matwell depth tolerance 9mm.
- Designed to sit just below the matting surface to allow for compression of the matting and to help prevent against potential surface damage of the profile..

## **Installation**

- Create required matwell size into flooring.
- Measure depth of matwell and select profile height required.
- Cut to desired length including mitres if applicable.
- Clean/ degrease the surface.
- Remove the fixing tape protective backing and place firmly in position.
- **Watch our installation video at [www.stairrods.co.uk](http://www.stairrods.co.uk) for more information.**

ANY QUESTIONS  
Please call 01207 591176 For friendly expert advice.

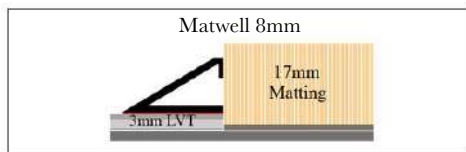
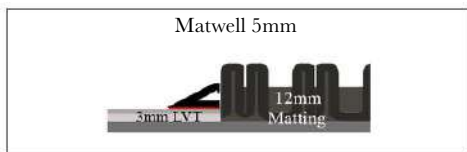

**See some installation examples below**

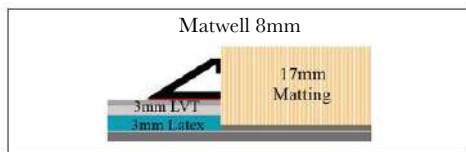
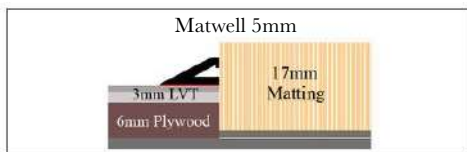

**Cleaning Guide, See page 105**



- An attractive and durable solid brass matwell surround for 12 and 17mm matting.
- Allows flooring to expand and contract without resistance.
- Available in 3 expansion options and 2 matting depths.

## Floating Matwell Prices

Profile	Size	Individual Price		50 Price (Any Trims)	
		Standard	Specialised	Standard	Specialised
12mm Small	90cm / 180cm / 270cm	£14.70 / £29.40 / £44.10	£19.81 / £39.62 / £59.43	£13.23 / £26.46 / £39.69	£17.83 / £35.66 / £53.49
12mm Medium	90cm / 180cm / 270cm	£15.82 / £31.64 / £47.46	£21.04 / £42.08 / £63.12	£14.24 / £28.48 / £42.72	£18.94 / £37.88 / £56.82
12mm Large	90cm / 180cm / 270cm	£18.06 / £36.12 / £54.18	£22.65 / £45.30 / £67.95	£16.25 / £32.50 / £48.75	£20.39 / £40.78 / £61.17
17mm Small	90cm / 180cm / 270cm	£16.87 / £33.74 / £50.61	£21.95 / £43.90 / £65.85	£15.18 / £30.36 / £45.54	£19.76 / £39.52 / £59.28
17mm Medium	90cm / 180cm / 270cm	£17.64 / £35.28 / £52.92	£23.24 / £46.48 / £69.72	£15.88 / £31.76 / £47.64	£20.92 / £41.84 / £62.76
17mm Large	90cm / 180cm / 270cm	£19.91 / £39.82 / £59.73	£25.51 / £51.02 / £79.53	£17.92 / £35.84 / £53.76	£22.96 / £45.92 / £68.88

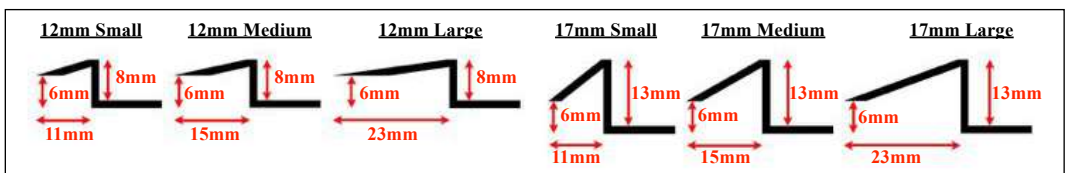

Carriage paid on 5 and over. Less than 5, add £7.50 for carriage, unless ordered with other items.



## **Product**

- Base material high quality brass..
- Innovative design allows flooring to expand and contract without resistance.
- Stick down product using an appropriate adhesive.
- Available in 2 depths 8mm for 12mm matting and 13mm for 17mm matting.
- Available in 3 expansion options 11, 15 & 23mm (Consult flooring manufacturer in regards to expansion requirements).

## **Installation**

- Create the required matwell size into flooring.
- Dependant on expansion required and matting thickness select appropriate profile.
- Use plywood or equivalent to build up subfloor (see guide table below).
- Cut profile to length including mitres if required.
- Fix using a non-expanding cartridge adhesive.
- **Watch our installation video at [www.stairrods.co.uk](http://www.stairrods.co.uk) for more information.**

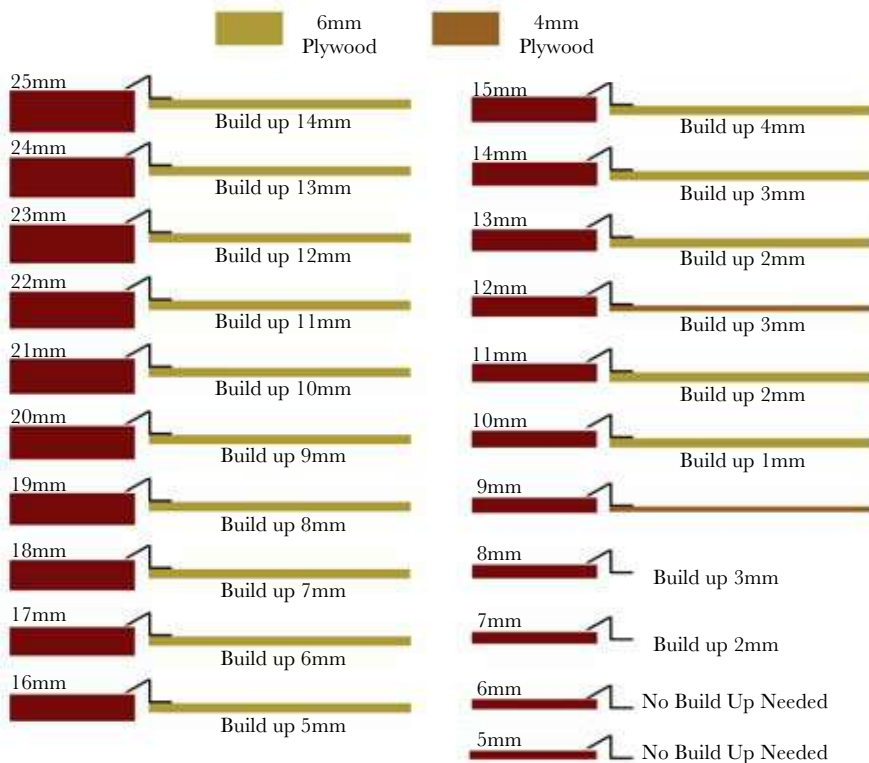

**Cleaning Guide, See page 105**



- High Quality Aluminium nosing for use with 8mm floating floors.
- Supplied pre-drilled and counter sunk.

## Ali Top Nose Prices

		Individual Price	50 Price (Any Trims)
Ali Top Nose	90cm	£8.38	£7.54
	180cm	£16.76	£15.08
	270cm	£25.14	£22.62

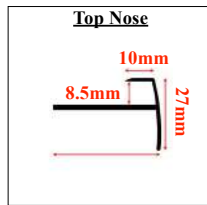
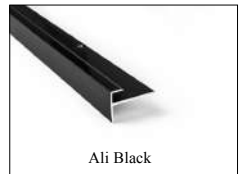

Carriage paid on 5 and over. Less than 5, add £7.50 for carriage, unless ordered with other items.



## **Product**

- Base material heavy duty aluminium.
- Supplied pre-drilled and countersunk on middle and back edge for added security.
- Supplied with Spax M screws requires T20 star bit (Do not Pre-drill).
- Overlap allows flooring to expand and contract up to 8mm.
- Supplied with 2mm MDF Spacer for raising base if required.

## **Installation**

- Cut profile to size and fix using the supplied Spax M screws.
- A bead of cartridge adhesive can be applied to base for added security.
- 2mm thick base to coincide with underlay (Raise base using the supplied MDF Spacer for thicker underlays).
- Install flooring allowing for required expansion gap (Consult flooring manufacturer regarding expansion requirements).

ANY QUESTIONS  
Please call 01207 591176 For friendly expert advice.

## **See some installation examples below**

Easyshims to the riser

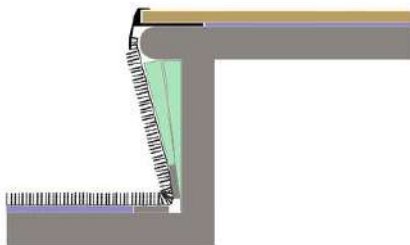

Top Nose fitted with 2mm Underlay and Easyshims to the riser

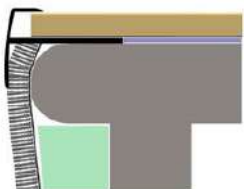

Top Nose fitted with 2mm MDF Strip, 4mm Underlay and Easyshims to the riser

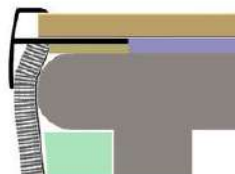

**Cleaning Guide, See page 105**



# Ali Wrap Nosing

Installing floors in our trims



- Wrap Nosing for LVP/LVT 2.5mm and 3mm on 6mm plywood prep.
- Wrap Nosing for 8mm, 6.5mm and 5mm WPC/SPC (rigid core) Flush and Overlap.
- Pre drilled

## Ali Wrap Nosing Prices

Profile Type	Size	Individual Price	50 Price
Ali Wrap Nosing LVT	90cm	£8.38	£7.54
	180cm	£16.76	£15.08
	270cm	£25.14	£22.62
Ali Wrap Nosing Flush 5mm WPC/SPC	90cm	£8.34	£7.51
	180cm	£16.68	£15.02
Ali Wrap Nosing Overlap 5mm WPC/SPC	90cm	£9.37	£8.73
	180cm	£18.74	£17.46
Ali Wrap Nosing Flush 6.5mm WPC/SPC	90cm	£8.63	£7.77
	180cm	£17.26	£15.54
Ali Wrap Nosing Overlap 6.5mm WPC/SPC	90cm	£9.66	£8.69
	180cm	£19.32	£17.38
Ali Wrap Nosing Flush 8mm WPC/SPC	90cm	£9.16	£8.24
	180cm	£18.32	£16.48
Ali Wrap Nosing Overlap 8mm WPC/SPC	90cm	£9.95	£8.96
	180cm	£19.90	£17.92

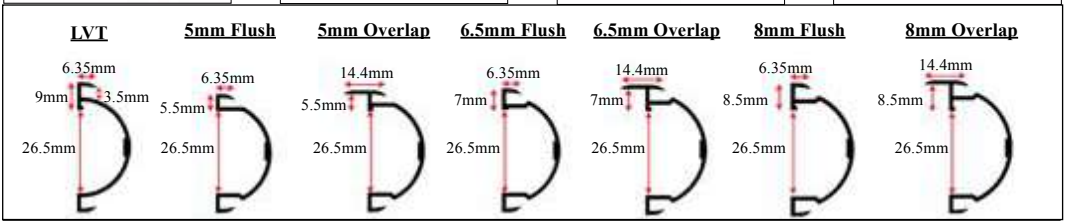

Carriage paid on 5 and over. Less than 5, add £7.50 for carriage, unless ordered with other items.



## **Product**

- Base material heavy duty aluminium.
- Pre-drilled and supplied with Spax M screws (Requires T20 star bit).
- Supplied with a pre-attached heat and moisture resistant adhesive tape.
- Fixes to pre-existing overhang tread up to 26mm thick.
- LVT Nosing designed for 2.5mm or 3mm LVT on 6mm plywood.
- WPC Nosing designed for 5, 6.5 & 8mm WPC/SPC with a peelable surface layer.
- The overlap profile is designed to allow for expansion of flooring products where applicable.
- Inlay sizes - 3mm LVT Wrap Nosing - 53mm Inlay.
  - 1mm Recess Wrap 5mm Flush - 53mm Inlay.
  - 1mm Recess Wrap 5mm Overlap - 55mm Inlay.
  - 1mm Recess Wrap 6.5mm Flush - 55mm Inlay.
  - 1mm Recess Wrap 6.5mm Overlap - 57mm Inlay.
  - 1mm Recess Wrap 8mm Flush - 58mm Inlay.
  - 1mm Recess Wrap 8mm Overlap - 60mm Inlay.

## **Installation**

- Cut the profile to the desired length.
- The use of a cartridge adhesive can provide a secondary fixing.
- Use the supplied Spax M screws to fix.
- Peel off the contact tape protective layer.
- Cut down inlay to the required length and width and insert into recess' (the use of a heat gun on LVT products can ease the installation).
- **Watch our installation video at [www.stairrods.co.uk](http://www.stairrods.co.uk) for more information.**
- **See some installation examples.**

2.5mm - 3mm LVT & 6mm Ply

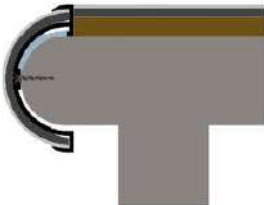

WPC 8mm Flush

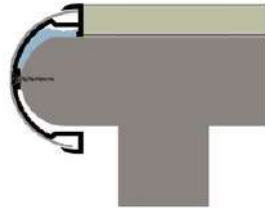

WPC 6.5mm Overlap

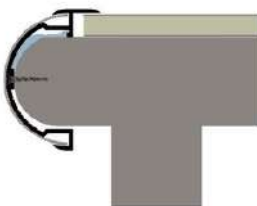



- The Ali Bendy Bull is a high quality aluminium stair profile.
- Innovative design allows the curve to be formed onsite.
- 2 options available - 1mm recess for WPC/SPC Rigid tile and 3mm recess for LVT.
- 1mm recess overlap version available for use where an expansion gap is required.

## Ali Bendybull Prices

Profile Type	Size	Individual Price	50 Price
<b>Ali Bendybull for LVT</b>	<b>90cm</b>	£11.53	£10.37
	<b>180cm</b>	£23.06	£20.74
	<b>270cm</b>	£34.59	£31.11
<b>Ali Bendybull for WPC/SPC</b>	<b>90cm</b>	£12.39	£11.15
	<b>180cm</b>	£24.78	£22.30
	<b>270cm</b>	£37.17	£33.45
<b>Ali Bendybull Overlap for WPC/SPC (Not Bendable)</b>	<b>90cm</b>	£12.61	£11.35
	<b>180cm</b>	£25.22	£22.70
	<b>270cm</b>	£37.83	£34.05

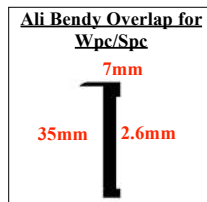
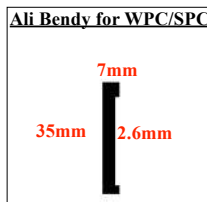
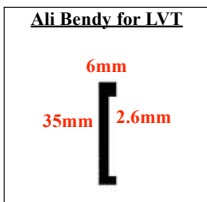
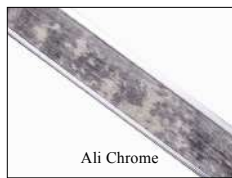

Carriage paid on 5 and over. Less than 5, add £7.50 for carriage, unless ordered with other items.



## **Product**

- Base material heavy duty aluminium.
- Innovative bend onsite finishing profile.
- Available in 2 recess options 1mm & 3mm dependant on flooring thickness.
- 3mm designed for use with LVT products, 1mm designed for WPC/SPC Rigid tile products with a peelable surface layer.
- Overlap option available for use where an expansion gap is required, maximum expansion tolerance up to 6mm.
- Pre-drilled and countersunk.
- Supplied with a high-grab, anti-plasticiser contact tape to secure the inlay.
- Supplied with Spax M self drilling screws (requires T20 star bit).
- Inlay sizes:
  - 3mm Recess LVT Bendy Bull - 27mm Inlay.
  - 1mm Recess SPC/WPC Bendy Bull Flush - 30mm Inlay.
  - 1mm Recess SPC/WPC Bendy Bull Overlap - 31mm Inlay.

## **Installation**

- Form a pre-bend prior to fixing.
- Mechanical primary fixing backed up by an adhesive secondary fixing.
- We recommend viewing our installation video before installing the Bendy Bull.
- **Watch our installation video at [www.stairrods.co.uk](http://www.stairrods.co.uk) for more information.**

## **See installation examples**

Ali Bendybull with 6mm plywood/LVT



Ali Bendybull with WPC/SPC (no plywood)



Bends Round Bullnose (plan view)

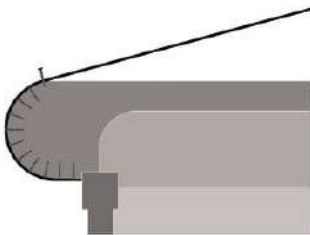



- High quality aluminium stick down cover profile for floating and non-floating flooring.
- Designed for LVT, Click LVT & WPC/SPC Rigid Tile products.

## Ali Tramline Transition Prices

Profile Type	Size	1 +	10 +	50 +
1mm Recess	180cm	£7.91	£5.81	£5.23
3mm Recess	180cm	£9.12	£7.02	£6.22
5mm Recess	180cm	£11.11	£9.01	£8.37



**Tramline Transition 1mm**

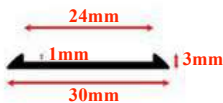

**Tramline Transition 3mm**

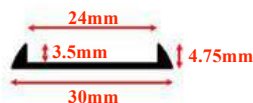

**Tramline Transition 5mm**

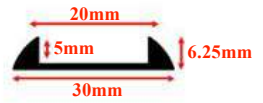

Carriage paid on 5 and over. Less than 5, add £7.50 for carriage, unless ordered with other items.



## **Product**

- Base material high quality aluminium.
- Available in 3 recess options 1, 3 & 5mm dependant on flooring thickness.
- Supplied with pre-attached heat and moisture resistant tape.
- Supplied with a high-grab, anti-plasticiser contact tape to secure the inlay.
- Profile allows up to 16mm expansion.
- Suitable for use with under floor heating.
- Ali Tramline Transition inlay size:
  - 1mm Recess Rigid Tile WPC/SPC - 24mm Inlay.
  - 3mm Recess Dryback LVT - 24mm Inlay.
  - 5mm Recess Click LVT - 19mm Inlay.

## **Installation**

- Designed for non-porous, level floating and non-floating flooring.
- Clean/ degrease the surface.
- Allow for correct expansion if required (refer to flooring manufacturer for specific expansion requirements).
- Remove the fixing tape protective backing from one side only.
- Use the fixing tape to adhere to the surface with least expansion resistance.
- Cut inlay, remove inlay tape protective surface and insert inlay into recess.
- **Watch our installation video at [www.stairrods.co.uk](http://www.stairrods.co.uk) for more information.**

ANY QUESTIONS  
Please call 01207 591176 For friendly expert advice.

## **See some installation examples below**

1mm allows 16mm expansion



3mm allows 16mm expansion



5mm allows 16mm expansion





- A perfectly matched aluminium joining profile from carpet to hard flooring.
- 1mm recess for Rigid tile WPC/SPC and 3mm for dryback LVT.

**Free Easywedges Supplied**

## Ali TramlineZ Prices

Profile Type	Size	1 +	10 +	50 +
1mm Recess	90cm	£10.38	£8.81	£7.93
	180cm	£20.77	£17.62	£15.86
3mm Recess	90cm	£10.75	£9.18	£8.26
	180cm	£21.50	£18.35	£16.53



**Carriage paid on 3 and over. Less than 3, add £7.50 for carriage, unless ordered with other items.**



## **Product**

- Base material high quality aluminium.
- 3mm designed for use with LVT products, 1mm designed for WPC/SPC Rigid tile products with a peelable surface layer.
- Supplied with MDF spacer to raise base for stretch fit installations.
- Supplied with a pre-attached high grab contact adhesive tape which is resistant to plasticiser migration for adhering inlay.
- Designed to nap down clamping carpet on to anchoring pins.
- Inlay size:
  - 1mm recess – 24mm.
  - 3mm recess – 24mm..

## **Installation**

- For use with stretch fit carpets and direct stick/ double stick installations.
- The Ali Tramline Z is designed to nap down, clamping the carpet onto the anchoring pins.
- Use the MDF Spacer cut into short lengths and placed under nail holes to raise base when used in conjunction with an underlay system.
- Alternatively the use of Easywedges can lower the front edge down to 6mm or 4mm.
- Cut inlay, remove recess tape protective surface and insert inlay into recess.
- **Watch our installation video at [www.stairrods.co.uk](http://www.stairrods.co.uk) for more information.**

ANY QUESTIONS  
Please call 01207 591176 For friendly expert advice.

**See an installation example below**

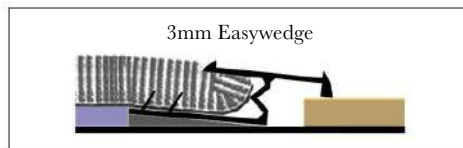

# Ali Tramline Reducer

Installing floors in our trims



- Attractive high quality aluminium ramp profile.
- Innovative design allows for height differences between 2 – 9mm.
- 2 recess options available 1mm & 3mm.

## Ali Tramline Reducer Prices

Profile	Length	1 +	10 +	50 +
2-3mm 1mm Recess	<b>180cm</b>	£9.01	£6.91	£5.62
4-5mm 1mm Recess	<b>180cm</b>	£9.70	£7.60	£6.19
6-7mm 1mm Recess	<b>180cm</b>	£10.55	£8.45	£6.89
8-9mm 1mm Recess	<b>180cm</b>	£12.20	£10.10	£8.23
2-3mm 3mm Recess	<b>180cm</b>	£9.82	£7.72	£6.95
4-5mm 3mm Recess	<b>180cm</b>	£10.37	£8.27	£7.44
6-7mm 3mm Recess	<b>180cm</b>	£11.43	£9.33	£8.40
8-9mm 3mm Recess	<b>180cm</b>	£13.13	£11.02	£9.92

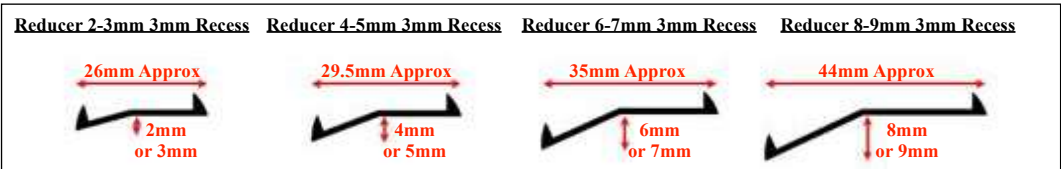
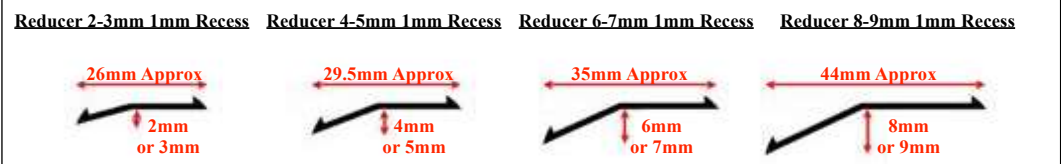
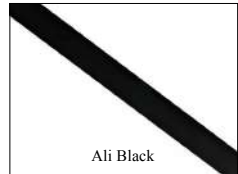
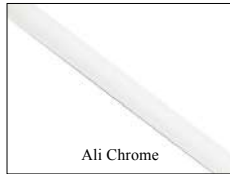
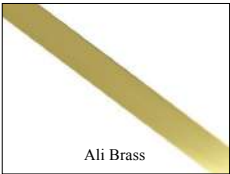

Carriage paid on 5 and over. Less than 5, add £7.50 for carriage, unless ordered with other items.



## **Product**

- Base material high quality aluminium.
- 2 recess options available 3mm designed for use with LVT products, 1mm designed for WPC/SPC Rigid tile products with a peelable surface layer.
- Can be used with floating and non-floating hard floors.
- Supplied with a pre-attached heat and moisture resistant adhesive tape.
- Supplied with a pre-attached high grab contact adhesive tape which is resistant to plasticiser migration for adhering inlay.
- Suitable for use with under floor heating.
- An innovative design allows one profile to accommodate two height differences, by turning the profile the height can be adjusted by 1mm.
  - 2 – 3mm drop – Inlay Size – 1mm 20.5mm / 3mm 21.0mm.
  - 4 – 5mm drop – Inlay Size – 1mm 25.0mm / 3mm 25.5mm.
  - 6 – 7mm drop – Inlay Size – 1mm 31.0mm / 3mm 31.0mm.
  - 8 – 9mm drop – Inlay Size – 1mm 39.0mm / 3mm 40.0mm.

## **Installation**

- Designed for non-porous, level floating and non-floating hard flooring.
- Clean/ degrease the surface.
- Check depth and use correct profile to accommodate drop.
- Allow for correct expansion if required (refer to flooring manufacturer for specific expansion requirements).
- Cut inlay, remove recess tape protective surface and insert inlay into recess.
- The use of heat application and a P-Groover to create a groove in the back of the LVT can help with installation.
- Suitable for use with underfloor heating.
- **Watch our installation video at [www.stairrods.co.uk](http://www.stairrods.co.uk) for more information.**

ANY QUESTIONS  
Please call 01207 591176 For friendly expert advice.

## **See some installation examples below**

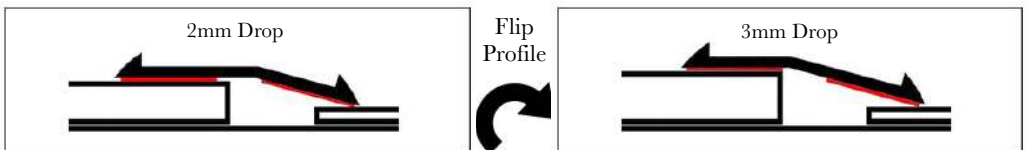

# Ali Tramline End Profile

Installing floors in our trims



- An attractive and discreet alternative to Scotia and Beading
- Available in 3 recess options 1, 3 & 5mm.
- Supplied with pre-attached tapes for adhering to skirting board and affixing inlay.

## Ali Tramline End Profile Prices

Profile Type	Size	1 +	10 +	50 +
1mm Recess	180cm	£6.10	£4.00	£3.60
3mm Recess	180cm	£7.69	£5.59	£4.53
5mm Recess	180cm	£8.82	£6.72	£6.05

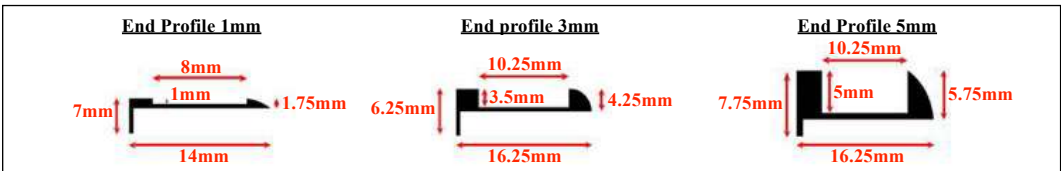
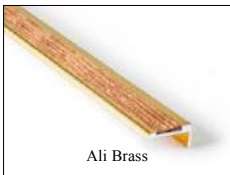

Carriage paid on 5 and over. Less than 5, add £7.50 for carriage, unless ordered with other items.



## **Product**

- Base material high quality aluminium.
- 3 recess options available 1mm for Rigid Tile SPC/WPC, 3mm for Dryback LVT and 5mm for Click LVT.
- Designed to accommodate up to a maximum expansion gap of 10 – 12mm.
- Used to cover and protect expansion gap required with floating floors.
- Supplied with a pre-attached heat and moisture resistant adhesive tape for fixing.
- Supplied with a pre-attached high grab contact adhesive tape which is resistant to plasticiser migration for adhering inlay.
- Inlay sizes:
  - 1mm recess WPC/SPC - 7mm Inlay.
  - 3mm recess LVT - 10mm Inlay.
  - 5mm recess Click LVT - 10mm Inlay.

## **Installation**

- Designed to be adhered to pre-prepared/painted skirting boards.
- Clean/ degrease the surface prior to adhesion.
- Cut inlay, remove recess tape protective surface and insert inlay into recess.
- Cut profile as required and install, making sure to keep the profile flat to the surface.
- Allow for correct expansion (refer to flooring manufacturer for specific expansion requirements).
- **Watch our installation video at [www.stairrods.co.uk](http://www.stairrods.co.uk) for more information.**

ANY QUESTIONS  
Please call 01207 591176 For friendly expert advice.

## **See some installation examples below**

1mm recess allows 10mm expansion



3mm recess allows 12mm expansion



5mm recess allows 12mm expansion



# Ali Pipe Covers

Installing floors in our trims



- An attractive accessory to the Ali Tramline range.
- 6 options available to accept materials ranging from 3 – 15mm.
- For use with various flooring products including LVT Click and Dryback, Rigid Tile SPC/WPC, Laminate and some Engineered wood flooring products.

## Pipe Cover Prices

Profile Type	1 +	16 +	50 +
3mm Recess	£4.60	£2.50	£2.25
5mm Recess	£4.67	£2.57	£2.32
8mm Recess	£4.89	£2.79	£2.51
10mm Recess	£5.08	£2.98	£2.69
12mm Recess	£5.26	£3.16	£2.84
15mm Recess	£5.60	£3.50	£3.15



Carriage paid on 16 and over. Less than 16, add £7.50 for carriage, unless ordered with other items.



## **The Product**

- Base material high quality aluminium.
- 6 options available dependant on flooring thickness.
- Loose laid, slots together via the 2 dovetail joints.
- Allows the flooring to expand and contract without resistance.
- Fits a 15mm Radiator pipe.

## **Installation**

- Simply cut the required flooring to size and place into the recess.
- The use of an adhesive can be used to secure the inlay.
- When using a hole saw the inner circumference is required to achieve the correct size.
- Hole saw size guide: (allowance of 2mm blade thickness)
  - 3mm Recess 44mm diameter = 48mm hole saw.
  - 5mm Recess 44mm diameter = 48mm hole saw.
  - 8mm Recess 44mm diameter = 48mm hole saw.
  - 10mm Recess 44mm diameter = 48mm hole saw.
  - 12mm Recess 44mm diameter = 48mm hole saw.
  - 15mm Recess 48mm diameter = 52mm hole saw.

ANY QUESTIONS  
Please call 01207 591176 For friendly expert advice.

	Minimum Clearance Needed	Maximum Expansion Hole
Ali Pipe Covers	16mm	44mm

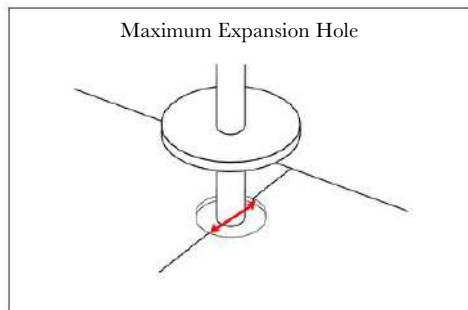
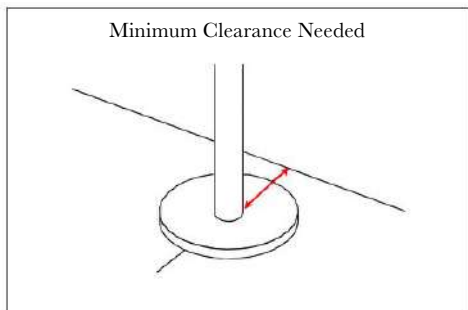

New

# Ali Zee Bar

99



- The Stairrods Zee bar has been designed to produce an aesthetically pleasing invisible turn when installing carpet where no visible fixings are desired i.e. against open spindles etc.

## Ali Zee Bar Prices

Profile Type	Individual Price	50 Price (Any Trims)
Ali Zee Bar 180cm	£6.28	£5.65



Ali Zee Bar

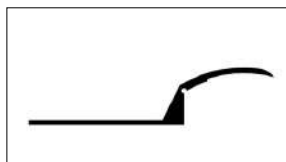

Carriage paid on 5 and over. Less than 5, add £7.50 for carriage, unless ordered with other items.



## **Product**

- The Stairrods Zee bar has been designed to produce an aesthetically pleasing invisible turn when installing carpet where no visible fixings are desired i.e. against open spindles etc.?
- Manufactured from high quality aluminium.
- Designed to nap down, clamping the carpet firmly into position.
- 9mm gully allows for carpet to be turned with ease.
- Uses gripper to secure into position, providing optimal strength.

## **Installation**

- Place the zee bar under the gripper and affix.
- Cut carpet allowing for a minimum turn of 15mm.
- Tuck the excessive carpet under the lip.
- Dress down using a block of wood to clamp the carpet into position.

ANY QUESTIONS  
Please call 01207 591176 For friendly expert advice.



## G9 Geordie Gripper Price

50 metres	£19.99
-----------	--------

- 9mm thick for use with thicker underlay systems i.e. 10-12mm.
- 2 rows of 4.5mm medium height anchoring pins.
- Made from 28mm wide by 120cm long high-quality plywood.
- Designed for timber subfloors using the 24mm ring shank nails to fix.
- Double bank for power stretching recommended.



## G6 Chopped Up Gripper Price

75 metres	£19
-----------	-----

- Pre-cut to 150mm lengths as per BS5325 for stick down applications.
- 2 rows of 4.5mm medium height anchoring pins.
- Made from 25mm wide high-quality plywood.
- Double bank for power stretching recommended.
- Consult adhesive manufacturer for adhesion specifications.



Pallet prices available

**Carriage paid on 2 and over on all Geordie Gripper.  
For 1 box add £7.50 for carriage, unless ordered with other items.**

**New****G7.5 - 3 row Medium Pin Gripper Price**

96 metres

£27.20

- 7.5mm thick for added strength and performance.
- 3 rows of 4.5mm medium height anchoring pins.
- Made from 25mm wide by 120cm long high-quality plywood.
- Designed for timber subfloors using the 19mm ring shank nails to fix.
- For use when superior tension holding abilities are required.
- Double bank for power stretching recommended.

**Available Spring 2022****New****G7.5 - 3 row Short Pin Gripper Price**

96 metres

£27.20

- For use with thinner pile carpets.
- 7.5mm thick for added strength and performance.
- 3 rows of 3.5mm short pin height anchoring pins.
- Made from 25mm wide by 120cm long high-quality plywood.
- Designed for timber subfloors using the 19mm ring shank nails to fix.
- For use when superior tension holding abilities are required.
- Double bank for power stretching recommended.

**Available Spring 2022****New****G7.5 - Blind Gripper Price**

120 metres

£27.20

- For use with double stick carpet installations.
- 7.5mm thick to accommodate a variety of underlay thicknesses.
- Made from 25mm wide by 120cm long high-quality plywood.
- Designed for timber subfloors using the 19mm ring shank nails to fix.
- Extra wide to produce a superior hold with added security against movement.
- Consult adhesive manufacturer for recommended adhesive selection.
- Non-branded to reduce the risk of possible discolouration from adhesive reaction.
- Note: If using a 6.5mm Underlay the 1mm difference should be taken into account as this could potentially mirror through on thinner carpet products.

**Hook Tape Price**

150 metres

£32.80

- 1.27mm thickness.



- Available in Standard and Specialised colours.
- Available in cut lengths from 15m to 50m
- Available in 50m spools
- Note: Spools may contain joins.

## Easybind Prices

Available in Standard Colours and Specialised Colours (SP)	Standard	Specialised
15m-50m lengths. Available in smaller quantities with a £7.50 carriage charge.	£2.85 per metre	£3.88 per metre
50m spool.	£2.33 per metre	£3.36 per metre
2 x 50m spool.	£2.08 per metre	£3.11 per metre



Beige, Black & Brown



Beige, Black & Brown



Blue, Green & Grey



Blue, Green & Grey



Pinks & Red



Multi Colour

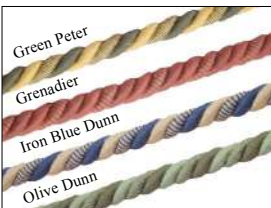

Multi Colour



Specialised



Specialised



## The Product

- Easybind is a simple but effective alternative to whipping carpet edges on stair runners and rugs. Easybind can be fitted to the carpet on site so no delays in waiting for the carpet to be whipped.

### Easybind Carpet Edging For Carpet Runners and Rugs.

- Simply measure the edges of the carpet where you will be fitting the Easybind and allow a little extra then cut accordingly.
- Prepare the carpet edges by cutting with a sharp knife to produce a clean cut. Be aware of any surface below the carpet when cutting so as not to cause damage.
- Easybind will fray when cut so to prevent this apply adhesive tape around the rope at the cutting point.
- Always start in the middle of a straight run as it is easier to produce a clean join on a straight section as opposed to a curve or corner. Peel backing off the adhesive tape.
- Be sure to run the rope edging parallel to the carpet edge leaving a gap to accommodate the glue gun nozzle.
- When going around an outside corner cut the binding not the rope and fold underneath, the same applies to an inside corner without the need to fold the binding on the back.
- When creating a join apply adhesive tape to the area that will be cut, this prevents the rope edging from fraying when being cut.
- After cutting match the rope pieces together. TIP: Have the ends of the adhesive tape visible to allow ease of removal. Seal the two pieces of rope with a spot of hot glue and peel the tape away.
- When you are happy with the join and the corners etc. Use the hot glue gun to apply a bead of glue between the binding and the carpet backing, pinching together as you go. Be careful not to get glue on the carpet.
- For longer runs try a piece of 3" x 2" to help attach large sections of the binding. Use a glue gun pad when the gun is not in use to avoid glue dripping onto either the floor or carpet.



## Easybind Accessories



Easybind glue gun, long nozzle and 10 Glue Sticks

£42.50



Easybind hot melt glue sticks (Pack of 10)

£5.00



## **Post Fitting**

Premier Trims should always be fitted with the protective tape on.

If the Premier Trim has been fitted without the tape. It's best to give a quick wipe with White vinegar.

## **Brass**

Remove spills immediately to limit corrosion with White vinegar. Brass will tarnish over time and we recommend a polishing cloth such as HG copper shine cloth available from most DIY stores. Avoid contact with floor coverings.

Should corrosion appear, we use a Mirka Total Finishing pad P1500 (grey). Rub the area to remove contamination and buff up with HG copper shine cloth. If in doubt, please email [sales@stairrods.co.uk](mailto:sales@stairrods.co.uk)

## **Satin Brass**

Remove spills immediately to limit corrosion with White vinegar. Brass will tarnish over time and we recommend a polishing cloth such as HG copper shine cloth available from most DIY stores. Avoid contact with floor coverings.

Should corrosion appear, we use a Mirka Total Finishing pad P1500 (grey). Rub the area to remove contamination and buff up with HG copper shine cloth. If in doubt, please email [sales@stairrods.co.uk](mailto:sales@stairrods.co.uk)

## **Antique bronze**

Remove spills immediately to limit corrosion with White vinegar. Brass will tarnish over time and we recommend a polishing cloth such as HG copper shine cloth available from most DIY stores. Avoid contact with floor coverings.

Should corrosion appear, we use a Mirka Total Finishing pad P1500 (grey). Rub the area to remove contamination and buff up with HG copper shine cloth. This may go down to the solid brass base however over time the 'rubbed' lighter area will tarnish/blend into the antique finish. If in doubt, please email [sales@stairrods.co.uk](mailto:sales@stairrods.co.uk)

## **Antique brass**

Remove spills immediately to limit corrosion with White vinegar. Brass will tarnish over time and we recommend a polishing cloth such as HG copper shine cloth available from most DIY stores. Avoid contact with floor coverings.

Should corrosion appear, we use a Mirka Total Finishing pad P1500 (grey). Rub the area to remove contamination and buff up with HG copper shine cloth. This may go down to the solid brass base however over time the 'rubbed' lighter area will tarnish/blend into the antique finish. If in doubt, please email [sales@stairrods.co.uk](mailto:sales@stairrods.co.uk)

## **Pewter**

Remove spills immediately to limit corrosion with White vinegar. Use a polishing cloth occasionally, such as HG copper shine cloth, available from most DIY stores. Avoid contact with floor coverings.

## **Chrome, Brushed Chrome, Satin Nickel, Polished Nickel and Black**

No maintenance required

# Point Of Sale Material



**Carpet Board**  
- FOC



**Stair Rod Box**  
- £20



**Floor Board**  
- FOC



**Easybind Swatch Box**  
- FOC



**Ali Tramline Trim Board**  
- FOC



**Floor Trim Box**  
-FOC



**Ali Wrap Nosing Board**  
- FOC



**Carpet Trim Box**  
- FOC



**Premier Inlay Board**  
- FOC



**Jubilee/Homepride Display**  
- FOC



**Bendybull Wholesaler Display**  
- £50



**Decorative Pipe Cover Board**  
- FOC



**Rods & Trims Sample Display**  
£2 per Rod/Trim @ 24"  
A Mix of Rods, Trims  
Mounting Board not included

# General Information

## **Carriage Charge**

### **Main Land UK**

Please see bottom of each page for carriage info.

### **Northern Ireland:**

Orders Under £75: £15 carriage charge

Any 270cm Order: £20 carriage charge

### **Channel Islands, Highlands/Aberdeen & Isle of wight:**

Orders Under £250: £20 carriage charge

## **Returns**

Any goods that are wrong or faulty please contact [sales@stairrods.co.uk](mailto:sales@stairrods.co.uk) and our friendly staff will help resolve the issue.

Any goods that have been ordered incorrectly or are not needed can be returned, but these need to be sent back by yourself. We no longer offer collections.

Any goods getting returned need to be in the same condition as we despatched them. We cannot credit any goods that have been cut or fitted.

Any returns goods will have a 25% restocking charge.

Please inform us [sales@stairrods.co.uk](mailto:sales@stairrods.co.uk) if you want to return any goods.