



The leading, most  
trusted experts  
in flooring.



EVERYDAY

**FAVOURITES**

National stock price list

April 2026 | v3.0



# It's never been easier to check stock, pay online and find deals.



Unlock bigger savings with our upgraded clearance section



Instantly see stock availability for your postcode



Pay invoices fast and keep orders moving smoothly

Download the myMercado app today



# EVERYDAY FAVOURITES



**This is our Everyday Favourites price list.  
It's designed for ease and convenience, with  
the products you rely on every day.**

You'll also find the latest price lists from exclusive Mercado brands like Everyoom, Lifestyle Floors & JHS – all in one place.

Local, discontinued, and special order ranges aren't included in this list. For those, contact your Area Sales Manager or the Sales Office.

**headlam**  
brands

KC KINGSMEAD  
CARPETS

TELENZO  
CARPETS

Fells  
Carpets & Flooring

manx  
Tomkinson

Kersaint  
Cobb



Your trusted flooring  
partner, supporting your  
business every day.



Nationwide  
distribution



Unrivalled  
product choice



Regional Customer  
Service Teams



Dedicated Area  
Sales Managers



Marketing  
support



Order and pay  
online 24/7

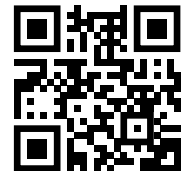

Scan to download  
the Headlam Brands app

Speak to your Area Sales Manager to open an account

## CONTENTS

## DOMESTIC FLOORING

Carpet	6
Artificial Grass	8
Vinyl	9
Laminate	10
LVT/SPC	10
Engineered Wood	11

## FLOOR PREPARATION

Spray Adhesives	21
-----------------	----

## CONTRACT FLOORING

Carpet	13
Carpet Tiles	13
Vinyl	13
Needlepunch	14
Entrance Matting	14

## UNDERLAY

Underlay	15
----------	----

## ACCESSORIES

Metals	16
Premier Metals	17
Gripper	17
Plywood	18
Hardflooring Accessories	18
Stair Nosings	19
PVC Accessories	20

## EXCLUSIVE MERCADO BRANDS

Everyroom	22
JHS	26
Lifestyle Floors	31
(Exclusively for independent retailers)	

## SUPPLIER PRICE LISTS (A-Z)

Altro	35
Ardex	36
Egger	37
F. Ball	38
Gerflor	40
Gradus	41
Heckmondwike	42
Kerakoll	43
MAPEI	44
Polyflor	45
Quantum	49
Rewmar	50
Tarkett	51
Ultra Floor	52
Uzin	55

## Carpet

RANGE NAME	Brand	Description	Widths	Backing	List cuts £m <sup>2</sup>	List rolls £m <sup>2</sup>
<b>ABINGDON</b>						
● COUNTRY COLLECTION	Abingdon	100% polypropylene	4 & 5m	Fleece	10.34	9.30
● STAINFREE RUSTIQUE TWIST	Abingdon	100% polypropylene	4 & 5m	Fleece	12.06	10.91
● STAINFREE RUSTIQUE ULTRA	Abingdon	100% polypropylene	4 & 5m	Fleece	14.47	12.06
● STAINFREE TWEED	Abingdon	100% polypropylene	4 & 5m	Fleece	18.73	16.89
● STAINFREE ULTRA	Abingdon	100% polypropylene	4 & 5m	Fleece	16.31	13.32
<b>ASSOCIATED WEAVERS</b>						
AQUARIUS (NEW)	Associated Weavers	100% polypropylene	4 & 5m	Fleece	15.74	14.16
CANOPUS (NEW)	Associated Weavers	100% polypropylene	4 & 5m	Fleece	12.99	10.99
CASTOR (NEW)	Associated Weavers	100% polypropylene	4 & 5m	Fleece	9.99	8.99
HOLMFIRTH (NEW)	Associated Weavers	100% polypropylene	4 & 5m	Fleece	12.99	11.39
INVICTUS ARIES	Associated Weavers	100% iVinci solution dyed olefin	4 & 5m	FusionBac	11.54	10.39
INVICTUS AURELIUS	Associated Weavers	100% iVinci solution dyed olefin	4 & 5m	FusionBac	15.74	14.16
INVICTUS CASSIUS	Associated Weavers	100% iVinci solution dyed olefin	4 & 5m	FusionBac	14.69	13.22
INVICTUS DARIUS	Associated Weavers	100% iVinci solution dyed olefin	4 & 5m	FusionBac	11.54	10.39
INVICTUS MAGNIFICUS	Associated Weavers	100% iVinci solution dyed olefin	4 & 5m	FusionBac	15.74	14.16
INVICTUS ORION	Associated Weavers	100% iVinci solution dyed olefin	4 & 5m	FusionBac	11.54	10.39
INVICTUS SIRIUS	Associated Weavers	100% iVinci solution dyed olefin	4 & 5m	FusionBac	14.69	13.22
INVICTUS TAURUS	Associated Weavers	100% iVinci solution dyed olefin	4 & 5m	FusionBac	13.64	12.28
ISLAND WEAVE	Associated Weavers	100% polypropylene	4 & 5m	Action bac	6.29	5.66
SOHO (NEW)	Associated Weavers	100% polypropylene	4 & 5m	FusionBac	10.49	9.44
STAINAWAY TWEED	Associated Weavers	100% polypropylene	4 & 5m	FusionBac	10.49	9.44
SUPERCOLOUR TWIST	Associated Weavers	100% polypropylene	4 & 5m	Felt & action bac	5.49	4.49
TIBERIUS	Associated Weavers	100% polypropylene	4 & 5m	Fleece	13.64	12.27
TRIBECA (NEW)	Associated Weavers	100% polypropylene	4 & 5m	FusionBac	13.11	11.79
<b>BALTA</b>						
GALA	Balta	100% polypropylene	4 & 5m	Felt & action bac	7.09	6.19
SOFT NOBLE	Balta	100% polypropylene	4 & 5m	Felt	5.99	4.99
<b>IDEAL</b>						
DALTON	Ideal	100% polypropylene	4 & 5m	Felt	3.29	2.99
DUBLIN TWIST COLLECTION	Ideal	100% polypropylene	4 & 5m	Felt & action bac	3.99	3.29
<b>LANO</b>						
DECOR (NEW)	Lano	100% polypropylene	4 & 5m	Fleece	9.99	8.49
FAIRFIELD DESIGN	Lano	100% polypropylene	4 & 5m	Fleece	11.49	9.99
HEATHERTWIST ELITE	Lano	100% polypropylene	4 & 5m	Fleece	11.49	9.99
HEATHERTWIST SUPREME	Lano	100% polypropylene	4 & 5m	Fleece	9.49	8.15
SCALA CLASSIC	Lano	100% polypropylene	4m	Impervious	13.99	11.99
SCALA COMBINATIONS - IM	Lano	100% polypropylene	4m	Impervious	12.49	10.99
SCALA COMBINATIONS - AB	Lano	100% polypropylene	4m	Action bac	10.49	9.49

● Price update

Carpet (cont.)

RANGE NAME	Brand	Description	Widths	Backing	List cuts £m <sup>2</sup>	List rolls £m <sup>2</sup>
LANO (cont.)						
SCALA STYLE	Lano	100% polypropylene	4m	Impervious	13.99	11.99
SOFT DISTINCTION	Lano	100% polypropylene	4 & 5m	Fleece	11.49	9.99
STARTWIST ELITE	Lano	100% polypropylene	4 & 5m	Fleece	11.49	9.99
STARTWIST SUPREME	Lano	100% polypropylene	4 & 5m	Fleece	9.49	8.49
MERCADO						
ANDES	Mercado	100% polypropylene	4 & 5m	Felt (previously action bac)	9.71	7.87
ATHENS	Mercado	100% polypropylene	4 & 5m	Action bac	6.00	4.53
ATLAS	Mercado	100% polypropylene	4 & 5m	Action bac	11.01	9.93
AURORA	Mercado	100% polypropylene	4 & 5m	Fleece	22.22	20.00
BELLEVUE	Mercado	100% polypropylene	4 & 5m	Fleece	11.72	10.64
BIRMA	Mercado	100% polypropylene	4 & 5m	Action bac	14.03	11.87
BROADWICK (NEW)	Mercado	100% polypropylene	4 & 5m	Felt & action bac	6.18	4.66
CAROUSEL	Mercado	100% polypropylene	4 & 5m	Action bac	11.01	9.93
CAROUSEL PLUS	Mercado	100% polypropylene	4 & 5m	Action bac	11.11	10.03
CASTILLE ELITE	Mercado	100% polypropylene	4 & 5m	Action bac	9.71	8.09
CASTILLE SUPER	Mercado	100% polypropylene	4 & 5m	Action bac	7.87	6.47
CASTLE PINES DELUXE	Mercado	100% polypropylene	4 & 5m	Action bac	7.88	6.75
CECILE	Mercado	100% polyester	4 & 5m	Action bac	10.04	7.89
CONAN	Mercado	100% polypropylene	4 & 5m	Felt	4.63	3.34
CORNWALL	Mercado	100% polypropylene	4 & 5m	Action bac	10.10	9.02
COUNTRY RETREAT (NEW)	Mercado	80% wool 15% PP, 5% PET	4 & 5m	Action bac	14.03	12.41
DAYTONA	Mercado	100% PES	4 & 5m	Action bac	5.32	3.98
FARADAY (NEW)	Mercado	100% polypropylene	4 & 5m	Felt & action bac	6.18	4.90
HERCULES	Mercado	100% polypropylene	4 & 5m	Felt	4.96	3.88
HIMALAYA CLASSIC	Mercado	100% polypropylene	4 & 5m	Action bac	8.31	6.47
HIMALAYA ELITE	Mercado	100% polypropylene	4 & 5m	Action bac	11.01	9.93
HONG KONG	Mercado	100% polypropylene	4 & 5m	Felt & action bac	7.55	6.47
HONEYBOURNE (NEW)	Mercado	100% polyester	4 & 5m	Action bac	7.62	5.66
LAZIO	Mercado	100% polypropylene	4 & 5m	Felt & action bac	7.29	6.21
MADISON SQUARE	Mercado	100% polypropylene	4 & 5m	Action bac	14.03	11.87
MELBOURNE (NEW)	Mercado	100% polypropylene	4 & 5m	Felt & action bac	6.18	4.66
NEBULA	Mercado	100% polypropylene	4 & 5m	Action bac	12.85	11.57
PARK AVENUE	Mercado	100% polypropylene	4 & 5m	Fleece	11.33	10.03
PASTICHE	Mercado	100% polypropylene	4 & 5m	Felt	4.63	3.34
PHOENIX	Mercado	100% polypropylene	4 & 5m	Fleece	11.33	10.03
REVOLUTION	Mercado	100% polypropylene	4 & 5m	Action bac	7.29	6.21
REVOLUTION SUPREME	Mercado	100% polypropylene	4 & 5m	Action bac	9.71	8.09
RIVENDELL TWIST	Mercado	100% polypropylene	4 & 5m	Action bac	6.47	5.17

● Price update

**Carpet (cont.)**

RANGE NAME	Brand	Description	Widths	Backing	List cuts £m <sup>2</sup>	List rolls £m <sup>2</sup>
MERCADO (cont.)						
● RIVENDELL ULTRA	Mercado	100% polypropylene	4 & 5m	Action bac	<b>8.63</b>	<b>7.55</b>
● SACRAMENTO CLASSIC	Mercado	100% polypropylene	4 & 5m	Action bac	<b>9.71</b>	<b>8.09</b>
● SACRAMENTO ELITE	Mercado	100% polypropylene	4 & 5m	Action bac	<b>12.41</b>	<b>10.03</b>
● SATURN	Mercado	100% polypropylene	4 & 5m	Action bac	<b>14.56</b>	<b>13.10</b>
● SHANNON TWIST	Mercado	100% polypropylene	4 & 5m	Felt & action bac	<b>5.17</b>	<b>3.77</b>
● SIGNATURE ELITE	Mercado	100% PES	4 & 5m	Fleece	<b>13.70</b>	<b>10.65</b>
● SIGNATURE LUXURY	Mercado	100% PES	4 & 5m	Fleece	<b>14.75</b>	<b>12.29</b>
● STONEHAVEN CLASSIC	Mercado	100% polypropylene	4 & 5m	Action bac	<b>8.63</b>	<b>7.23</b>
● STONEHAVEN ELITE	Mercado	100% polypropylene	4 & 5m	Action bac	<b>10.79</b>	<b>9.39</b>
● TURBO	Mercado	100% polypropylene	4 & 5m	Felt	<b>4.48</b>	<b>3.34</b>
● VILAMOURA	Mercado	100% polypropylene	4 & 5m	Action bac	<b>9.45</b>	<b>7.83</b>
● WALL STREET	Mercado	100% polypropylene	4 & 5m	Action bac	<b>9.71</b>	<b>8.09</b>

**Artificial Grass**

BRAND & QUALITY NAME	Range	Pile	Thickness	Widths	List cuts £m <sup>2</sup>	List rolls £m <sup>2</sup>
MERCADO						
● AUSTRALIA	Essential Lawns	Polyethylene (PE) (c-shape yarn) & polypropylene (PP) (curly yarn)	45mm	4 & 5m	<b>10.62</b>	<b>8.94</b>
● BRAZIL	Essential Lawns	Polyethylene (PE) (flat yarn) & polypropylene (PP) (curly yarn)	35mm	4 & 5m	<b>8.97</b>	<b>7.28</b>
● GREECE	Essential Lawns	Polyethylene (PE) (diamond shape yarn) & polypropylene (PP) (curly yarn)	30mm	4 & 5m	<b>6.40</b>	<b>4.94</b>
● ITALY	Essential Lawns	Polyethylene (PE) (flat yarn) & polypropylene (PP) (curly yarn)	40mm	4 & 5m	<b>9.51</b>	<b>7.83</b>
● TURKEY	Essential Lawns	Polyethylene (PE) (diamond shape yarn) & polypropylene (PP) (curly yarn)	40mm	4 & 5m	<b>6.73</b>	<b>5.05</b>
● BLAIR (NEW)	Open Plains	PE monofilament straight & PP monofilament curled (UV stabilized)	28mm	4 & 5m	<b>8.09</b>	<b>7.01</b>
● GLADE (NEW)	Open Plains	PE monofilament straight & PP monofilament curled (UV stabilized)	35mm	4 & 5m	<b>5.93</b>	<b>4.85</b>
● HEATH (NEW)	Open Plains	PE monofilament straight & PP monofilament curled (UV stabilized)	38mm	4 & 5m	<b>9.17</b>	<b>7.55</b>
● MEADOW (NEW)	Open Plains	PP monofilament straight & PP monofilament curled (UV stabilized)	15mm	4 & 5m	<b>3.77</b>	<b>2.69</b>
● MOOR (NEW)	Open Plains	PE monofilament straight & PP monofilament curled (UV stabilized)	38mm	4 & 5m	<b>15.66</b>	<b>12.96</b>
● VALE (NEW)	Open Plains	PE monofilament straight & PP monofilament curled (UV stabilized)	30mm	4 & 5m	<b>14.05</b>	<b>11.34</b>

● Price update

## Vinyl

RANGE NAME	Brand	Backing	Widths	List cuts £m <sup>2</sup>	List rolls £m <sup>2</sup>
<b>LEOLINE</b>					
ARTISTE (NEW)	Leoline	Felt	2, 3 & 4m	8.99	7.49
COMFYTEX DELUXE MAX	Leoline	Felt	2, 3 & 4m	10.59	8.29
COMFYTEX DELUXE PRO (check stock)	Leoline	Felt	2, 3 & 4m	10.59	8.29
COMFYTEX PU	Leoline	Felt	2, 3 & 4m	10.25	7.99
NOVUS	Leoline	Cushion	2, 3 & 4m	9.75	8.49
PREMIUM ELITE (NEW)	Leoline	Cushion	2 & 4m	13.39	10.49
STUDIO CASA	Leoline	Cushion	2, 3 & 4m	12.35	9.99
TECHNIQUE	Leoline	Cushion	2, 3 & 4m	11.85	9.49
ULTIMATE ESSENCE (NEW)	Leoline	Cushion	2, 3 & 4m	11.29	8.29
WOODLINE	Leoline	Cushion	2, 3 & 4m	10.75	8.49
<b>MERCADO</b>					
MONZA LUXURY	Mercado	Cushion	2, 3 & 4m	8.46	6.35
MONZA PREMIUM	Mercado	Felt	2, 3 & 4m	10.58	8.47
ONYX TX	Mercado	Felt	2, 3 & 4m	9.53	7.41
PLAZA TX	Mercado	Felt	2, 3 & 4m	7.74	5.62
<b>RHINOFLOOR</b>					
RHINOFLOOR RHINOTEX	Rhinofloor	Felt	2, 3 & 4m	12.89	9.56
RHINOFLOOR SUPER DELUXE	Rhinofloor	Cushion	2, 3 & 4m	9.49	4.74
RHINOFLOOR XL TEX	Rhinofloor	Cushion	2, 3 & 4m	8.46	4.22
<b>TARKETT</b>					
GOLIATH	Tarkett	Cushion	2, 3 & 4m	11.49	7.83
GRIPSTARTEX	Tarkett	Cushion	2, 3 & 4m	9.49	4.21
HOMESTYLE	Tarkett	Cushion	2, 3 & 4m	9.40	4.17
TEXSTAR	Tarkett	Felt	2, 3 & 4m	12.89	9.56
<b>ULTRAGRIP</b>					
ENTICE	Ultra Grip	Felt	2, 3 & 4m	12.71	9.53
EMINENCE	Ultra Grip	Felt	2, 3 & 4m	13.78	10.07
EMPRESS	Ultra Grip	Felt	2, 3 & 4m	13.77	10.06
ENRICH	Ultra Grip	Felt	2, 3 & 4m	13.77	10.06
EVOKE	Ultra Grip	Cushion	2, 3 & 4m	13.78	10.06
XTREME	Ultra Grip	Cushion	2, 3 & 4m	13.77	10.38

Laminate

BRAND & RANGE NAME	Height	Suitability	Water resistant	Plank size w x l	Pack size	Packs per pallet	List packs £m <sup>2</sup>	List pallets £m <sup>2</sup>	Standholder* £m <sup>2</sup>
<b>BERRY ALLOC</b>									
CADENZA	8mm	AC4	-	214 x 1383mm	2.66m <sup>2</sup>	56	10.44	8.35	9.66
CHATEAU†	8mm	AC5	100hrs	84 x 504mm	1.02m <sup>2</sup>	48	22.98	19.32	21.26
OCEAN	8mm	AC5	100hrs	190 x 1288mm	2.2m <sup>2</sup>	56	15.14	12.01	14.01
<b>MERCADO</b>									
ASPEN HERRINGBONE	8mm	AC3	-	101 x 606mm	2.57m <sup>2</sup>	48	9.49	6.99	-
<b>QUICKSTEP</b>									
CAPTURE	9mm	AC4	15 year water warranty	212 x 1380mm	2.05m <sup>2</sup>	52	24.84	23.43	-
CLASSIC HYDRO	8mm	AC4	10 year water warranty	190 x 1200mm	1.60m <sup>2</sup>	60	13.49	12.81	-
CREO HYDRO	7mm	AC4	10 year water warranty	190 x 1200mm	1.82m <sup>2</sup>	60	10.60	9.99	-
ELIGNA HYDRO	8mm	AC4	15 year water warranty	156 x 1380mm	1.72m <sup>2</sup>	60	19.78	18.55	-
IMPRESSIVE	8mm	AC4	15 year water warranty	190 x 1380mm	1.84m <sup>2</sup>	60	19.98	18.72	-
IMPRESSIVE ULTRA	12mm	AC5	15 year water warranty	190 x 1380mm	1.31m <sup>2</sup>	60	30.63	28.15	-
MAJESTIC	9.5mm	AC5	15 year water warranty	240 x 2050mm	2.95m <sup>2</sup>	33	28.86	27.35	-
MUSE	8mm	AC4	15 year water warranty	396 x 1200mm	1.90m <sup>2</sup>	52	23.00	21.54	-
IMPRESSIVE DESIGN	8mm	AC4	15 year water warranty	131 x 655mm	1.20m <sup>2</sup>	84	21.23	19.98	-

\* 7.5% standholder discount applied to pack orders only for Berry Alloc standholders, on orders placed from 20th April 2026. For Egger standholder pricing, please refer to the Egger supplier price list.

† For herringbone installs of Chateau, equal amounts of A & B packs must be used.

LVT/SPC

BRAND & RANGE NAME	Type	Thickness	Wear layer	Plank size w x l	Pack size	Packs per pallet	List packs £m <sup>2</sup>	List pallets £m <sup>2</sup>	Standholder* £m <sup>2</sup>
<b>FIRMFIT</b>									
FIRMFIT ORIGINAL PLANK	SPC	5mm	0.5mm	176 x 1213mm	2.35m <sup>2</sup>	45	22.67	18.35	20.97
FIRMFIT ORIGINAL HERRINGBONE	SPC	5mm	0.5mm	123 x 615mm	2.27m <sup>2</sup>	54	22.67	19.43	20.97
FIRMFIT PREGROUTED TILES	SPC	5.5mm	0.5mm	405 x 810mm	2.3m <sup>2</sup>	42	25.91	21.59	23.97
FIRMFIT PREGROUTED TILES (XT DECORS)	SPC	5.5mm	0.5mm	405 x 810mm	1.97m <sup>2</sup>	45	25.91	21.59	23.97
FIRMFIT SILENT PLANK	SPC	7.5mm	0.5mm	232 x 1532mm	2.13m <sup>2</sup>	48	32.39	29.15	29.96
FIRMFIT SILENT HERRINGBONE	SPC	7.5mm	0.5mm	142 x 710mm	1.82m <sup>2</sup>	50	32.39	30.23	29.96
<b>H FLOR</b>									
DECOTILE 30 (PLANK)	Dryback	2mm	0.3mm	180 x 1200mm	4.75m <sup>2</sup>	60	11.99	9.99†	11.29
DECOTILE 30 (TILE)	Dryback	2mm	0.3mm	300 x 600mm	4.86m <sup>2</sup>	72	11.99	9.99†	11.29
DECOTILE 55 (PLANK)	Dryback	2.5mm	0.55mm	180 x 1200mm	3.89m <sup>2</sup>	60	14.99	11.99†	13.87
DECOTILE 55 (TILE)	Dryback	2.5mm	0.55mm	300 x 600mm	3.96m <sup>2</sup>	72	14.99	11.99†	13.87
HARMONY LVT NEW (PLANK)	Dryback	2.5mm	0.55mm	180 x 1200mm	3.89m <sup>2</sup>	60	15.99	13.49	14.79

\* 7.5% standholder discount applied to pack orders only for FirmFit and HFLOR standholders, on orders placed from 20th April 2026.

† Pallet prices apply to orders of a single colour over 100m<sup>2</sup> (nearest pack equivalent).

● Price update

## LVT/SPC (cont.)

BRAND & RANGE NAME	Type	Thickness	Wear layer	Plank size w x l	Pack size	Packs per pallet	List packs £m <sup>2</sup>	List pallets £m <sup>2</sup>	Standholder* £m <sup>2</sup>
H FLOR (cont.)									
HARMONY LVT NEW (TILE)	Dryback	2.5mm	0.55mm	300 x 600mm	3.96m <sup>2</sup>	72	15.99	13.49	14.79
HARMONY UNITY	Dryback	2.5mm	0.55mm	76 x 228mm	3.763m <sup>2</sup>	48	17.99	14.99	16.64
HARMONY TRANQUILITY	Dryback	2.5mm	0.55mm	114 x 457mm	3.763m <sup>2</sup>	48	17.99	14.99	16.64
MERCADO									
TLC ORIGINAL (PLANK)	Dryback	2mm	0.3mm	152.4 x 914.4mm	3.34m <sup>2</sup>	70	15.49	13.49†	-
TLC ORIGINAL (PLANK)	Dryback	2mm	0.3mm	184.2 x 1219mm	3.37m <sup>2</sup>	68	15.49	13.49†	-
TLC ORIGINAL (TILE)	Dryback	2mm	0.3mm	304.8 x 304.8mm	3.34m <sup>2</sup>	72	15.49	13.49†	-
TLC ORIGINAL (TILE)	Dryback	2mm	0.3mm	457.2 x 457.2mm	3.34m <sup>2</sup>	72	15.49	13.49†	-
TLC MASSIMO (SPQ)	Dryback	2.5mm	0.55mm	76.2 x 228.6mm	3.34m <sup>2</sup>	64	18.49	17.49†	-
TLC MASSIMO (LPQ)	Dryback	2.5mm	0.55mm	101.6 x 609.6mm	3.34m <sup>2</sup>	64	18.49	17.49†	-
TLC MASSIMO (MWF)	Dryback	2.5mm	0.55mm	76.2 x 914.4mm 101.6 x 914.4mm 152.4 x 914.4mm	3.62m <sup>2</sup>	63	18.49	17.49†	-
TLC MASSIMO (PLANK)	Dryback	2.5mm	0.55mm	184.2 x 1219.2mm	3.37m <sup>2</sup>	70	17.49	16.49†	-
TLC MASSIMO (TILE)	Dryback	2.5mm	0.55mm	304.8 x 609.6mm	3.34m <sup>2</sup>	64	17.49	16.49†	-
TLC ORIGINAL (PLANK)	Dryback	2mm	0.3mm	152.4 x 914.4mm	3.34m <sup>2</sup>	70	15.49	13.49†	-
TLC ORIGINAL (PLANK)	Dryback	2mm	0.3mm	152.4 x 914.4mm	3.34m <sup>2</sup>	70	15.49	13.49†	-
QUICKSTEP									
ALPHA BLOOM	Engineered vinyl floor	6mm	-	209 x 1494mm	1.873m <sup>2</sup>	52	32.24	29.01	-
ALPHA BLOS	Engineered vinyl floor	5mm	-	189 x 1251mm	2.128m <sup>2</sup>	44	26.60	23.93	-
ALPHA CIRO	Engineered vinyl floor	6mm	-	126 x 630mm	0.794m <sup>2</sup>	108	33.59	30.26	-
ALPHA ILLUME	Engineered vinyl floor	6mm	-	428 x 856mm	2.198m <sup>2</sup>	48	32.24	29.01	-
ALPHA ORO	Engineered vinyl floor	5mm	-	303 x 610mm	1.848m <sup>2</sup>	48	26.60	23.93	-

\* 7.5% standholder discount applied to pack orders only for FirmFit and HFLOR standholders, on orders placed from 20th April 2026.

† Pallet prices apply to orders of a single colour over 100m<sup>2</sup> (nearest pack equivalent).

## Engineered Wood

BRAND & RANGE NAME	Description	Colour	Plank size w x l	Pack size	List packs £m <sup>2</sup>
BMK					
CHENE 14/3 ENGINEERED	14mm stained brushed & UV lacquered 125mm wide	125 COGNAC B	125 x 300-1200mm*	1.8	23.99
CHENE 14/3 ENGINEERED	14mm brushed and oiled 125mm wide	125 B & O	125 x 300-1200mm*	1.8	22.99
CHENE 14/3 ENGINEERED	14mm UV lacquered 125mm wide	125 LACQ	125 x 300-1200mm*	1.8	22.99
CHENE 14/3 ENGINEERED	14mm brushed & UV lacquered 125mm wide	125 B+L	125 x 300-1200mm*	1.8	22.99
CHENE 14/3 ENGINEERED	14mm golden handscraped UV lacquered 125mm wide	125 G/H	125 x 300-1200mm*	1.8	22.99
CHENE 14/3 ENGINEERED	14mm invisible oiled 125mm wide	125 INVISIBL	125 x 300-1200mm*	1.8	22.99
CHENE 14/3 ENGINEERED	14mm stained brushed & lacquered 150mm wide	150 COGNAC	150 x 300-1200mm*	1.44	24.49

● Price update

## Engineered Wood (cont.)

BRAND & RANGE NAME	Description	Colour	Plank size w x l	Pack size	List packs £m <sup>2</sup>
BMK (cont.)					
CHENE 14/3 ENGINEERED	14mm brushed and oiled 150mm wide	150 B+O	150 x 300-1200mm*	1.44	24.49
CHENE 14/3 ENGINEERED	14mm UV lacquered 150mm wide	150 LACQ	150 x 300-1200mm*	1.44	24.49
CHENE 14/3 ENGINEERED	14mm brushed & UV lacquered 150mm wide	150 B+L	150 x 300-1200mm*	1.44	24.49
CHENE 14/3 ENGINEERED	14mm golden handscraped UV lacquered 150mm wide	150 G/H	150 x 300-1200mm*	1.44	24.49
CHENE 14/3 ENGINEERED	14mm invisible oiled 150mm wide random	150 INVISIBL	150 x 300-1200mm*	1.44	24.49
CHENE 14/3 ENGINEERED	14mm stained brushed & UV lacquered 190mm wide	190 COGNAC	190 x 1900mm	2.166	26.49
CHENE 14/3 ENGINEERED	14mm brushed and oiled 190mm wide	190 B+O	190 x 1900mm	2.166	26.49
CHENE 14/3 ENGINEERED	14mm lacquered 190mm wide	190 LACQUERE	190 x 1900mm	2.166	26.49
CHENE 14/3 ENGINEERED	14mm brushed & UV lacquered 190mm wide	190 B+L	190 x 1900mm	2.166	26.49
CHENE 14/3 ENGINEERED	14mm golden handscraped UV lacquered 190mm wide	190 G/H	190 x 1900mm	2.166	26.49
CHENE 14/3 ENGINEERED	14mm invisible oiled 190mm wide	190 INVIS O	190 x 1900mm	2.166	26.49
CHENE 14/3 HB	14mm stained brushed & UV lacquered	COGNAC	90 x 400mm	1.872	26.49
CHENE 14/3 HB	14mm brushed and oiled	B+O	90 x 400mm	1.872	26.49
CHENE 14/3 HB	14mm UV lacquered	LACQUERED	90 x 400mm	1.872	26.49
CHENE 14/3 HB	14mm brushed & UV lacquered	B+L	90 x 400mm	1.872	26.49
CHENE 14/3 HB	14mm golden handscraped UV lacquered	GOLDEN HAND	90 x 400mm	1.872	26.49
CHENE 14/3 HB	14mm invisible oiled	INVISIBLE O	90 x 400mm	1.872	26.49
CHENE 14/3 HB	14mm brushed double smoked UV lacquered	DOUBLE SMOKE	90 x 400mm	1.872	26.49
CHENE 14/3 HB	14mm smoked brushed and white oiled	SMOKED WHITE	90 x 400mm	1.872	26.49
CHENE 14/3 HB	14mm stained brushed & UV lacquered	NO 3	90 x 400mm	1.872	26.49
CHENE 14/3 HB	14mm handscraped brushed distressed oiled	BROWN OILED	90 x 400mm	1.872	26.49
CHENE 18/4 ENGINEERED	18mm brushed double smoked UV lacquered 150mm wide	150 D SMOKED	150 x 300-1200mm*	1.08	29.49
CHENE 18/4 ENGINEERED	18mm smoked brushed and white oiled 150 wide	150 W SMOKED	150 x 300-1200mm*	1.08	29.49
CHENE 18/4 ENGINEERED	18mm stained brushed & UV lacquered 150 wide	150 NO 3	150 x 300-1200mm*	1.08	29.49
CHENE 18/4 ENGINEERED	18mm handscraped brushed distressed oiled 150 wide	150 BROWN	150 x 300-1200mm*	1.08	29.49
CHENE 20/6 ENGINEERED	20mm stained brushed & UV lacquered 150mm wide	150 COGNAC	150 x 300-1200mm*	1.08	30.99
CHENE 20/6 ENGINEERED	20mm brushed and oiled 150mm wide	150 B+O	150 x 300-1200mm*	1.08	30.99
CHENE 20/6 ENGINEERED	20mm UV lacquered 150mm wide	150 LACQUERE	150 x 300-1200mm*	1.08	30.99
CHENE 20/6 ENGINEERED	20mm brushed & UV lacquered 150mm wide	150 B+L	150 x 300-1200mm*	1.08	30.99
CHENE 20/6 ENGINEERED	20mm golden handscraped UV lacquered 150mm wide	150 G/H	150 x 300-1200mm*	1.08	30.99
CHENE 20/6 ENGINEERED	20mm invisible oiled 150mm wide	150 INVISIBL	150 x 300-1200mm*	1.08	30.99
CHENE 20/6 ENGINEERED	20mm stained brushed & UV lacquered 190mm wide	190 COGNAC	190 x 1900mm	1.805	36.49
CHENE 20/6 ENGINEERED	20mm brushed and oiled 190mm wide	190 B+O	190 x 1900mm	1.805	36.49
CHENE 20/6 ENGINEERED	20mm lacquered 190mm wide	190 LACQUERE	190 x 1900mm	1.805	36.49
CHENE 20/6 ENGINEERED	20mm brushed & UV lacquered 190mm wide	190 B+L	190 x 1900mm	1.805	36.49
CHENE 20/6 ENGINEERED	20mm golden handscraped UV lacquered 190mm wide	190 G/H	190 x 1900mm	1.805	36.49
CHENE 20/6 ENGINEERED	20mm invisible oiled 190mm wide	190 INVISIBL	190 x 1900mm	1.805	36.49

\*Random lengths

● Price update

### Contract Carpet

RANGE NAME	Brand	Description	Widths	Backing	List cuts £m <sup>2</sup>	List rolls £m <sup>2</sup>
LANO						
SCALA COMBINATIONS IM	Lano	100% polypropylene	4m	Impervious gel	12.49	10.99
SCALA COMBINATIONS AB	Lano	100% polypropylene	4m	Action bac	10.49	9.49
MERCADO						
● SOMERSET GEL	Mercado	100% polypropylene	4m	Impervious gel	12.41	11.11

### Carpet Tiles

BRAND & RANGE NAME	Description	Pile weight	Thickness	Backing	Tile size	Tiles per box	M <sup>2</sup> per box	Price per m <sup>2</sup> (£)	Price per box (£)
BALSAN									
AVENUE	100% solution dyed nylon	520gsm	5.6mm	Bback	50 x 50cm	24	6	10.99	65.94
SKYLINE	100% polypropylene	350gsm	5.1mm	Bback	50 x 50cm	24	6	6.99	41.94
SKYSCRAPER	100% polypropylene	450gsm	5.9mm	Bback	50 x 50cm	24	6	9.25	55.50
TRUST	100% solution dyed nylon	500gsm	5.7mm	Bback	50 x 50cm	24	6	11.95	71.70
GERFLOR									
LATOUR 2	100% aquafil solution dyed nylon	470gsm	5.5mm	Bitumen	50 x 50cm	16	4	14.55	58.20
MERCADO									
● BEDFORD	100% polypropylene	900gsm	8mm	Bitumen	50 x 50cm	16	4	12.83	51.32
● HONG KONG	100% polypropylene	1500gsm	11mm	Bitumen	50 x 50cm	12	3	16.04	48.12
● PRIMAVERA	100% polypropylene	900gsm	9mm	Bitumen	50 x 50cm	16	4	12.83	51.32

### Contract Vinyl

BRAND & RANGE NAME	Thickness (mm)	Wear layer	Widths	List cuts £m <sup>2</sup>	List rolls £m <sup>2</sup>
IVC					
ISAFE 70 WOODS	2.15	0.70	2m	14.94	12.99
ISAFE 70 COLOUR AND MATERIALS	2.15	0.70	2m	12.41	10.79
IPERFORM 70 WOODS	2.15	0.70	2m	13.79	11.99
IPERFORM 70 COLOURS AND MATERIALS	2.15	0.70	2m	13.79	11.99

● Price update

## Needlepunch

RANGE NAME	Brand	Description	Total thickness	Widths	List cuts £m <sup>2</sup>	List rolls £m <sup>2</sup>
● REWIND ULTRACORD	BFS	100% polypropylene	6mm	2m	7.48	6.41
● BEDFORD	Mercado	100% polypropylene	7mm	2/4m	6.94	5.87
● CHEVY RIB	Mercado	100% polypropylene	4mm	4m	4.80	3.20
● CHEVY VELOUR	Mercado	100% polypropylene	5mm	4m	4.80	3.20
● INDEX CORD	Mercado	100% polypropylene	4mm	4m	2.45	1.92
● PRIMAVERA GEL	Mercado	100% polypropylene	8mm	2/4m	6.94	5.87

## Entrance Matting

RANGE NAME	Brand	Description	Pile weight	Widths	List cuts £m <sup>2</sup>	List rolls £m <sup>2</sup>
● ALICANTE	Mercado	100% polypropylene	700gsm	2m	7.48	5.87
● HEAVY TREAD	Mercado	100% polypropylene	1300gsm	2m	11.22	9.62
● KOKOS	Mercado	100% polypropylene	1500gsm	2m	15.50	12.83
● MAGNUM	Mercado	100% polypropylene	1040gsm	2m	10.69	7.48
● MAGNUS	Mercado	100% polypropylene	1040gsm	2m	11.76	8.01
● MATRIX	Mercado	100% polypropylene	1300gsm	2m	11.22	9.62
● HONG KONG	Mercado	100% polypropylene	1500gsm	2m	13.90	11.22

● Price update



The UK's widest  
range and largest  
stock availability

Underlay

BRAND & RANGE NAME	Thickness	Density	Tog	Sound insulation	Suitability	Roll size	Roll price £
<b>BALL &amp; YOUNG</b>							
ROMA	6.9mm	3087g/m <sup>2</sup>	0.8	31dB	Heavy contract	10m <sup>2</sup>	59.99
<b>CARPENTER</b>							
MAGIC 8MM	8mm	85kg/m <sup>3</sup>	2.13	34dB	Domestic	15.07m <sup>2</sup>	21.50
MAGIC 10MM	10mm	85kg/m <sup>3</sup>	2.47	38dB	Domestic	15.07m <sup>2</sup>	24.99
EVERYDAY LIVING 8MM	8mm	85kg/m <sup>3</sup>	2.29	33dB	Domestic	15.07m <sup>2</sup>	21.99
EVERYDAY LIVING 10MM	10mm	85kg/m <sup>3</sup>	2.71	36dB	Domestic	15.07m <sup>2</sup>	24.99
HI LUX HD 9MM	9mm	125kg/m <sup>3</sup>	2.34	43dB	Domestic	15.07m <sup>2</sup>	34.49
HI LUX HD 11MM	11mm	125kg/m <sup>3</sup>	3.04	47dB	Domestic	15.07m <sup>2</sup>	37.49
MIDAS 8MM	8mm	85kg/m <sup>3</sup>	2.29	33dB	Domestic	15.07m <sup>2</sup>	26.99
MIDAS 10MM	10mm	85kg/m <sup>3</sup>	2.71	36dB	Domestic	15.07m <sup>2</sup>	28.99
MIDAS 12MM	12mm	85kg/m <sup>3</sup>	3.26	41dB	Domestic	15.07m <sup>2</sup>	30.99
PERFECT LIVING 9MM	9mm	100kg/m <sup>3</sup>	2.65	40dB	Domestic	15.07m <sup>2</sup>	36.99
PERFECT LIVING 10MM	10mm	100kg/m <sup>3</sup>	2.86	41dB	Domestic	15.07m <sup>2</sup>	37.99
POWERSTEP 9MM	9mm	145kg/m <sup>3</sup>	2.6	40dB	Domestic & light contract	15.07m <sup>2</sup>	47.99
RICHSTEP 9MM	9mm	125kg/m <sup>3</sup>	2.35	42dB	Domestic	15.07m <sup>2</sup>	41.99
EXTRASTEP 6MM	6mm	180kg/m <sup>3</sup>	1.5	33dB	Domestic & heavy contract	15.07m <sup>2</sup>	47.99
DEEPSTEP 11MM	11mm	125kg/m <sup>3</sup>	2.78	46dB	Domestic	15.07m <sup>2</sup>	47.99
PROSTEP 8MM	8mm	180kg/m <sup>3</sup>	2.07	36dB	Domestic & heavy contract	15.07m <sup>2</sup>	49.99
<b>CLOUD 9</b>							
CIRRUS	9mm	116kg/m <sup>3</sup>	2.6	39-41dB	Domestic	15.07m <sup>2</sup>	55.99
CONTRACT	8mm	167kg/m <sup>3</sup>	2	35-37dB	Domestic & heavy contract	15.07m <sup>2</sup>	62.99
CONNOISSEUR 10MM	10mm	155kg/m <sup>3</sup>	2.8	42dB	Domestic	15.07m <sup>2</sup>	65.99
CHARLES 11MM	11mm	153kg/m <sup>3</sup>	2.9	44dB	Domestic	15.07m <sup>2</sup>	49.99
CUMULUS	11mm	113kg/m <sup>3</sup>	3.1	43dB	Domestic & light contract	15.07m <sup>2</sup>	61.99
RADIANCE	6mm	196kg/m <sup>3</sup>	1.3	31dB	Contract & underfloor heating	15.07m <sup>2</sup>	63.99
SUPER CONTRACT	10mm	166kg/m <sup>3</sup>	2.3	39-42dB	Domestic & contract	15.07m <sup>2</sup>	69.99
<b>COSI</b>							
COSI 8MM	8mm	92kg/m <sup>3</sup>	2.4	31dB	Domestic	15.07m <sup>2</sup>	34.99
COSI 10MM	10mm	90kg/m <sup>3</sup>	3	44dB	Domestic	15.07m <sup>2</sup>	39.99
<b>DURALAY</b>							
TIMBERMATE EXCEL	3.6mm	707kg/m <sup>3</sup>	0.55	23dB	Wood & laminate	15.07m <sup>2</sup>	69.99
DURAFIT 650 - BLACK	6.5mm	415kg/m <sup>3</sup>	1.1	29dB	Heavy contract	15.07m <sup>2</sup>	76.50
HEATFLOW UNDERLAY	6.1mm	495kg/m <sup>3</sup>	0.75	31dB	Sponge rubber	10.00m <sup>2</sup>	59.99
<b>TREDAIRE</b>							
SOFTWALK UNDERLAY	9mm	110kg/m <sup>3</sup>	2.69	41dB	Domestic	15.07m <sup>2</sup>	46.99
AMBIENCE 9MM	9mm	145kg/m <sup>3</sup>	2.37	39dB	Domestic	15.07m <sup>2</sup>	52.99
TREADMORE	7.95mm	3100g/m <sup>2</sup>	1.03	32dB	Crumb rubber	10.96m <sup>2</sup>	64.29
DREAMWALK 11MM	11mm	110kg/m <sup>3</sup>	3.13	44dB	Domestic	15.07m <sup>2</sup>	50.99

● Price update

## Underlay (cont.)

BRAND & RANGE NAME	Thickness	Density	Tog	Sound insulation	Suitability	Roll size	Roll price £
<b>FOOTFALL</b>							
● FOOTFALL - SERENITY UNDERWOOD	3.5mm	1.26kg/m <sup>2</sup>	0.8	23dB	Wood & laminate	10.00m <sup>2</sup>	<b>31.49</b>
● FOOTFALL - DS65 PREMIUM	6.5mm	2.65kg/m <sup>2</sup>	1.1	30dB	Heavy contract	15.07m <sup>2</sup>	<b>82.49</b>
● FOOTFALL - SERENITY SUPREME	11mm	2.4kg/m <sup>2</sup>	2.67	34dB	Crumb rubber	10.00m <sup>2</sup>	<b>65.27</b>
<b>TEXFELT</b>							
SPRINGBOND - 9MM	9mm	100kg/m <sup>3</sup>	2.3	41dB	Domestic & light contract	15.07m <sup>2</sup>	<b>59.99</b>
SPRINGBOND - 11MM	11mm	100kg/m <sup>3</sup>	2.3	41dB	Domestic	15.07m <sup>2</sup>	<b>69.99</b>

● Price update

## Metals

PRODUCT	Supplier code	Colour	Length	Qty. per tube	Per tube £	Per length £
CARPET EDGE - STANDARD	M20.3A	Silver	0.90m	45	<b>46.17</b>	<b>1.20</b>
CARPET EDGE - STANDARD	M20.9A	Silver	2.70m	15	<b>46.17</b>	<b>3.58</b>
COVER STRIP - CARPET	M10.3A	Silver	0.90m	45	<b>49.71</b>	<b>1.28</b>
COVER STRIP - CARPET	M10.9A	Silver	2.70m	15	<b>49.71</b>	<b>3.87</b>
COVER STRIP - CONTRACT	M11.3A	Silver	0.90m	45	<b>53.00</b>	<b>2.03</b>
COVER STRIP - CONTRACT	M11.9A	Silver	2.70m	15	<b>53.00</b>	<b>4.12</b>
COVER STRIP - EXTRA WIDE	M12.3A	Silver	0.90m	45	<b>82.49</b>	<b>2.13</b>
COVER STRIP - EXTRA WIDE	M12.9A	Silver	2.70m	15	<b>82.49</b>	<b>6.42</b>
DUALGRIP - STANDARD	M30.3A	Silver	0.90m	45	<b>59.00</b>	<b>1.53</b>
DUALGRIP - STANDARD	M30.9G	Gold	2.70m	15	<b>66.00</b>	<b>5.13</b>
DUALGRIP - STANDARD	M30.9A	Silver	2.70m	15	<b>59.00</b>	<b>4.58</b>
DUALGRIP - HEAVY DUTY	M31.9A	Silver	2.70m	9	<b>69.99</b>	<b>9.12</b>
SQUARE EDGE	M72.9A	Silver	2.70m	15	<b>90.00</b>	<b>5.27</b>
COVER STRIP - VINYL	M01.3A	Silver	0.90m	45	-	<b>1.17</b>
COVER STRIP - VINYL	M01.9A	Silver	2.70m	15	<b>45.17</b>	<b>3.52</b>
VINYL EDGE - MEDIUM	M03.3A	Silver	0.90m	45	<b>59.87</b>	<b>1.55</b>
VINYL EDGE - MEDIUM	M03.9A	Silver	2.70m	15	<b>59.87</b>	<b>4.65</b>
VINYL EDGE - SMALL	M02.3A	Silver	0.90m	45	-	<b>1.28</b>
VINYL EDGE - SMALL	M02.9A	Silver	2.70m	15	<b>49.44</b>	<b>3.85</b>
Z BAR - 9MM	M34.3A	Silver	0.90m	45	<b>62.39</b>	<b>1.62</b>
Z BAR - 9MM	M34.9A	Silver	2.70m	15	<b>62.39</b>	<b>4.85</b>

● Price update

## Metals - stick down

PRODUCT	Brand	Colour	Length	Qty. per tube	Per tube (£)	Per length (£)
ANGLE EDGE - 8MM	M04.9AMA	Matt Silver	2.70	10	74.00	8.13
ANGLE EDGE - 14MM	M05.9AMA	Matt Silver	2.70	10	98.00	14.35
EURO COVER STRIP	M13.9AMA	Matt Silver	2.70	10	91.99	11.60
EURO COVER STRIP	M13.9GMA	Matt Gold	2.70	10	85.00	11.60
NOSING - 15MM	M75.9AMA	Matt Silver	2.70	10	99.00	15.20
NOSING - 9MM	M74.9AMA	Matt Silver	2.70	10	73.07	11.25

## Premier Metals

PRODUCT	Brand	Colour	Length	Qty. per tube	Per tube £	Per length £
SINGLE EDGE - CARPET AND VINYL	M26.3CH	Chrome	0.90	15	227.99	19.19
SINGLE EDGE - CARPET AND VINYL	M26.9CH	Chrome	2.70	5	227.99	50.89
DUALGRIP - HEAVY DUTY	M36.3BB	Brushed Black	0.90	15	91.49	9.59
DUALGRIP - HEAVY DUTY	M36.9BB	Brushed Black	2.70	5	91.49	25.09
DUALGRIP - HEAVY DUTY	M36.9BS	Brushed Steel Nickel	2.70	5	91.49	25.09
Z BAR	M38.3CH	Chrome	0.90	15	237.99	19.19
Z BAR	M38.9CH	Chrome	2.70	5	237.99	50.89

## Premier Metals - stick down

PRODUCT	Brand	Colour	Length	Qty. per tube	Per tube £	Per length £
COVER STRIP	M13.3CHA	Chrome	0.90	15	242.99	19.79
COVER STRIP	M13.9CHA	Chrome	2.70	5	242.99	50.89
RAMP EDGE - MEDIUM	M08.9CHA	Chrome	2.70	5	238.49	50.89
RAMP EDGE - SMALL	M09.9CHA	Chrome	2.70	5	235.49	50.89

## Gripper

PRODUCT	Per box £
GRIPPER - PROFESSIONAL WOOD	53.99

## Plywood

PRODUCT	Grade	Per sheet £
FG1 5.5MM 4'x2'	Flooring grade	11.29
FG1 5.5MM 8'x4'	Flooring grade	34.99
FG1 9MM 8'x4'	Flooring grade	53.99
MLH 5.5MM 8'x4'	Non flooring grade	17.99
Q 6MM 8'x4'	Non flooring grade	18.99
SP101 5.5MM 4'x2'	Flooring grade	9.49
SP101 5.5MM 8'x4'	Flooring grade	30.99
SP101 9MM 8'x4'	Flooring grade	45.99

## Hardflooring Accessories

PRODUCT	Length	Per length £
UNIVERSAL SCOTIA	2.84	3.07
UNIVERSAL TRANSITION	0.90	11.55
UNIVERSAL TRANSITION	2.70	30.24
SOLID OAK SCOTIA	2.40	19.35
SOLID OAK TRANSITION	2.70	40.47
WATERPROOF SCOTIA	2.40	7.96



## STAIR NOSINGS cut & drilled (if required)

**No Floorcovering/direct - ramped** Gauge: 0 mm



**Vinyl/Resilient Floor - slenderline** Gauge: 2.0-3.5 mm

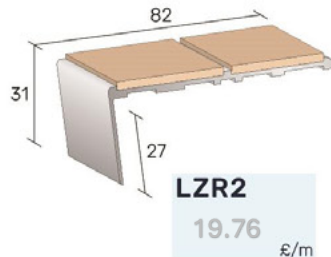
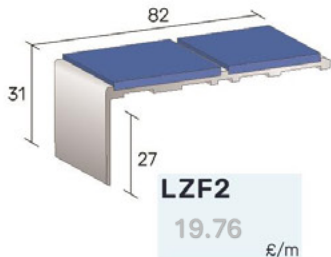
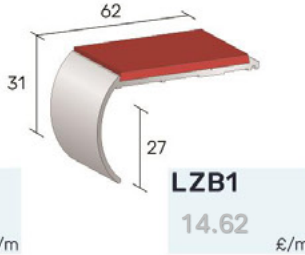

## Trims and Angles

Satin Etched Aluminium

11.57

**LZTRIM** 2.75m length £/length

### LZUTA90° & LZUTA83°

welded 360 x 360 mm, 20 per box

**LZUTA90°**

11.57 £/box

**LZUTA83°**

11.57 £/box

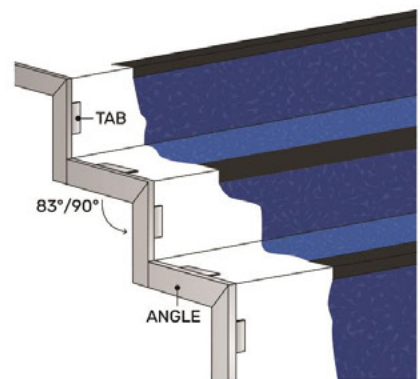

**Carpet/Carpet Tiles - heavy duty** Gauge 4.0-7.0 mm

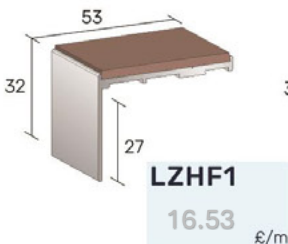



Colours shown here are for guide purposes only and are only as accurate as the printing process allows. Always request sample for exact colour match. Samples are available on all profiles.

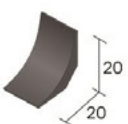

## PVC ACCESSORIES

### Cove formers & Capping strips Listed colours in stock, others colours available via order\*

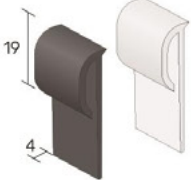
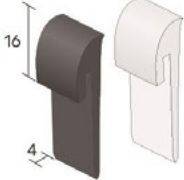
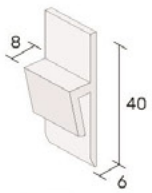
					
BLACK only <b>LZCF20</b> 50 x 2m lengths/box <b>218</b> £/box	BLACK only <b>LZCF</b> 40 x 2m lengths/box <b>188.8</b> £/box	BLACK <b>LZCS1</b> 40 x 2m lengths/box <b>192.8</b> £/box	BLACK & WHITE <b>LZCS2</b> 5 x 20m coils/box <b>45.80</b> £/coil	BLACK & WHITE <b>LZQCC1</b> 40 x 2m lengths/box <b>254.40</b> £/box	WHITE <b>LZCT</b> 50 x 2m lengths/box <b>595</b> £/box

### Dim Strips, Transitions BLACK in stock, others colours available via order\*

				
<b>LZT200</b> 5 x 25m coils/box <b>32.25</b> £/coil	<b>LZT250</b> 5 x 25m coils/box <b>34.5</b> £/coil	<b>LZR40/5</b> 25 x 2m lengths/box <b>500</b> £/box	<b>LZD35/5</b> 25 x 2m lengths/box <b>373</b> £/box	<b>LZD35/7.5</b> 25 x 2m lengths/box <b>479</b> £/box

### Skirtings

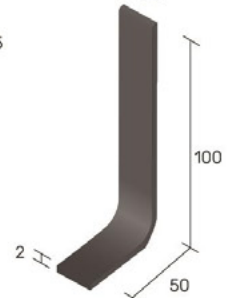







**LZSI** BLACK  
Set-In Skirting  
14 x 2m length/box  
**85.40** £/box

**LZSO** BLACK  
Sit-On Skirting  
30 x 2m lengths/box  
**115.20** £/box

### Ramps BLACK in stock, others colours available via order\*

<i>flat</i> 		<i>ribbed</i> 	
<b>LZFT450</b> 50 x 2m lengths/box <b>7.84</b> £/length	<b>LZFT600</b> 40 x 2m lengths/box <b>8.62</b> £/length	<b>LZT450</b> 50 x 2m lengths/box <b>7.84</b> £/length	<b>LZT600</b> 40 x 2m lengths/box <b>8.62</b> £/length

### TOP-CLIP BLACK in stock, others colours available via order / 10 x 2.75m lengths/tube, sold in tubes

			
<b>LZTC36T</b> <b>10.45</b> £/length	<b>LZTC42R</b> <b>17.38</b> £/length	<b>LZTC45R</b> <b>20.22</b> £/length	
			
<b>LZTB1</b> <b>13.34</b> £/length	<b>LZTB2</b> <b>19.64</b> £/length	<b>LZTB3P</b> <b>22.96</b> £/length	<b>LZTB3G</b> <b>22.96</b> £/length

Colours shown here are for guide purposes only and are only as accurate as the printing process allows.  
\*Some profile/colour combinations are subject to minimum order quantities. Always request sample for exact colour match.

**Spray Adhesives**

RANGE NAME	Boxes per pallet	1 box (12 cans) £
MULTI PURPOSE SPRAY	154	26.99
MULTI PURPOSE SPRAY NON CHLORINATED	154	26.99
CONTACT	154	36.99
VINYL	154	49.99
SPYDER STICK	154	31.99
SPYDER STICK NC	154	31.99
SPYDER GRAB (CONTACT)	154	40.99
SPYDER VINYL	154	55.99
● G25 NON CHLORINATED CARPET SPRAY	126	29.07
● G56 NON CHLORINATED PREMIUM HIGH GRAB CONTACT ADHESIVE	126	50.62



We stock all the tools you need to measure and fit flooring properly. Visit [mercado.co.uk](https://mercado.co.uk) or speak to your ASM to find out more.

# Price list

April 2026  
v3.0



Everyroom

## Carpet

Range	Description	Colours	Widths	Backing	Full rolls price (£m <sup>2</sup> )	Cuts at roll price (£m <sup>2</sup> )
Alaska	100% polypropylene saxony	8	4 & 5m	Action bac & felt back	4.31	5.39
Baywood	100% polypropylene	12	4 & 5m	Action bac	5.39	6.79
Bexhill	100% polyester twist	12	4 & 5m	Action bac & felt back	4.00	5.33
Bridgeport - check stock	100% polypropylene saxony	8	4 & 5m	Action bac	8.63	10.79
Brixham	100% polypropylene saxony	8	4 & 5m	Action bac	6.47	7.87
Carrick Cove - check stock	100% polypropylene twist	8	4 & 5m	Action bac & felt back	4.96	6.25
Cedar Falls	100% polypropylene twist	8	4 & 5m	Action bac	6.79	8.09
Eastbourne Elite	100% polypropylene saxony	12	4 & 5m	Action bac	8.76	10.52
Eastbourne Luxury	100% polypropylene saxony	12	4 & 5m	Action bac	9.93	11.68
Fairbourne - check stock	80% wool/20% polypropylene	9	4 & 5m	Action bac	8.99	9.99
Kronos	100% polypropylene	12	4 & 5m	Action bac	6.43	8.18
Littlebourne - check stock	50% wool/50% polyester	8	4 & 5m	Action bac	9.71	10.79
Logan (new colours)	100% polypropylene saxony	12	4 & 5m	Action bac	6.42	7.94
Mullion - check stock	100% polypropylene saxony	10	4 & 5m	Action bac	8.09	9.71
Nomi	100% soft polyester	12	4 & 5m	Duplex backing	5.52	6.63
Polperro	100% polypropylene twist	12	4 & 5m	Action bac	6.79	8.09
San Francisco	100% polypropylene	6	4 & 5m	Felt back	2.79	4.08
Salcombe - check stock	100% polypropylene saxony	10	4 & 5m	Action bac	7.49	8.99
Seaford	100% polyester twist	8	4 & 5m	Action bac	5.84	7.60
Seaton Valley (new colours)	100% polypropylene saxony	9	4 & 5m	Action bac	9.39	10.79
Sennen Twist	100% polypropylene twist	10	4 & 5m	Action bac	5.71	7.01
Trinity Sands - check stock	100% polypropylene	10	4 & 5m	Blue felt	7.29	8.79
Velocity Twist	100% polypropylene twist	8	4 & 5m	Action bac & felt back	3.04	4.44
Whitesands	100% polypropylene twist	8	4 & 5m	Action bac & felt back	2.82	3.96
Woodford	100% polypropylene loop & hobnail	16	4 & 5m	Felt back	3.55	4.63
Price update						

## Laminate

Range	Description	Decors	Plank size	Pack size (m <sup>2</sup> )	Planks per pack	Full pallets (£m <sup>2</sup> )	Pack (£m <sup>2</sup> )
Woodland	8mm 4V laminate, Class 32/AC4	6	1292mm (l) x 193mm (w)	1.99	8	6.34	9.51
Forest Trail	7mm 4V laminate, Class 31/AC3	6	1292mm (l) x 193mm (w)	2.49	10	4.75	7.18

## LVT

Range	Thickness/wear layer	Decors	Pack size (m <sup>2</sup> )	Peices per box	Pallet (£m <sup>2</sup> )	Pack (£m <sup>2</sup> )
Identity LVT	2mm dryback LVT with a 0.3mm wear layer	7	7" Plank 4.752	22	8.29	8.99
		3	Tile 4.86	27		
Identity Parquet LVT	2mm dryback LVT with a 0.3mm wear layer	7	4.7	99	8.49	8.99

Pallet rate applies to orders over 100m<sup>2</sup>

## Vinyl

Range	Thickness/wear layer	Colours	Widths	Backing	Full rolls price (£m <sup>2</sup> )	Cuts at roll price (£m <sup>2</sup> )
Citrino	2mm/0.2mm	8	2, 3 & 4m	Cushion	3.19	4.29
Perla	2.8mm/0.25mm	14	2, 3 & 4m	Cushion	4.44	5.81
Saxon Bay	2.4mm/0.15mm	10	2, 3 & 4m	Felt	4.49	5.89
Viking Bay	1.9mm/0.15mm	12	2, 3 & 4m	Textile	4.43	5.81
Whitby Tex	2mm/0.2mm	12	2, 3 & 4m	Textile	5.69	7.49

## Underlay

Range	Thickness	Roll length	Roll width	Core density (kg/m <sup>3</sup> )	Product density (kg/m <sup>3</sup> )	Selling price per roll
Everyroom cushion underlay 8mm	8mm	11m	1.37m	70	76	21.99
Everyroom cushion underlay 10mm	10mm	11m	1.37m	70	75	25.99
Everyroom cushion underlay 12mm	12mm	11m	1.37m	70	73	33.99
Everyroom HD underlay 9mm	9mm	11m	1.37m	140	143	34.49
Everyroom HD underlay 11mm	11mm	11m	1.37m	140	142	37.49

## Gripper

Range	Size (mm)	Pieces per box	Boxes per pallet	Nails	Pins	Per pack
Wood	1520 (l) x 20.2 (w) x 5.5 (d)	100	40	10	65	19.99
Dual Purpose	1520 (l) x 20.2 (w) x 5.5 (d)	100	40	10	65	19.99
Concrete	1520 (l) x 20.2 (w) x 5.5 (d)	100	40	10	65	19.99

# Price List

April 2026

V3.0

## Commercial broadloom carpet

	Width (m)	Pile Weight (g/m <sup>2</sup> )	Backing	Wear Guarantee	Roll Price (£/m <sup>2</sup> )	Cut Price (£/m <sup>2</sup> )
● <b>Elevate</b> Loop Pile - 100% solution dyed nylon	4&5	720	Action	7 Years	£15.11	£16.19
● <b>Freelance</b> Cut Pile - 100% nylon	4	835	Action	10 Years	£22.13	£24.29
● <b>New Andaman</b> Cut Pile – 100% polypropylene	4	700	Action	10 Years	£11.87	£13.49
● <b>Universal Heathers A/B</b> Cut Pile - 100% polypropylene	4	1100	Action	10 Years	£14.03	£15.11

## Residential broadloom carpet

	Width (m)	Pile Weight (g/m <sup>2</sup> )	Backing	Wear Guarantee	Roll Price (£/m <sup>2</sup> )	Cut Price (£/m <sup>2</sup> )
● <b>Drayton Heathers</b> Twist pile - 100% polypropylene	4&5	640	Action & felt	N/A	£7.01	£8.09
<b>Haywood Twist Standard</b> (check stock) Twist pile – 80% wool 10% polypropylene 10% nylon	4&5	840	Action	N/A	£10.95	£13.65
<b>Haywood Twist Super</b> Twist pile – 80% wool 10% polypropylene 10% nylon	4&5	1150	Action	N/A	£12.99	£15.99
<b>Haywood Twist Premier</b> Twist pile – 80% wool 10% polypropylene 10% nylon	4&5	1450	Action	N/A	£14.99	£17.99
<b>Haywood Twist Premier Stripe</b> (check stock) Twist pile 80% wool 10% polypropylene 10% nylon	4&5	1450	Action	N/A	£15.95	£19.45
<b>Haywood Twist Ultimate</b> Twist pile – 80% wool 10% polypropylene 10% nylon	4&5	1685	Action	N/A	£16.99	£19.99
<b>Haywood Twist Luxury</b> (check stock) Twist pile – 80% wool 10% polypropylene 10% nylon	4&5	2035	Action	N/A	£19.95	£23.25
<b>New Elford Twist Standard</b> Twist pile - 80% wool 20% polypropylene	4&5	850	Action	N/A	£10.99	£13.99

- Price update

## Residential broadloom carpet

	Width (m)	Pile Weight (g/m <sup>2</sup> )	Backing	Wear Guarantee	Roll Price (£/m <sup>2</sup> )	Cut Price (£/m <sup>2</sup> )
<b>New Elford Twist Super</b> Twist pile - 80% wool 20% polypropylene	4&5	1150	Action	N/A	£12.99	£15.99
<b>New Elford Twist Premier</b> Twist pile - 80% wool 20% polypropylene	4&5	1550	Action	N/A	£13.99	£16.99
● <b>Revive Twist Super</b> Saxony pile - 100% polypropylene - 100% recyclable	4&5	950	Fleece	N/A	£8.63	£9.71
● <b>Revive Twist Elite</b> Saxony pile - 100% polypropylene - 100% recyclable	4&5	1400	Fleece	N/A	£9.71	£10.79

## Impervious carpet

	Width (m)	Pile Weight (g/m <sup>2</sup> )	Backing	Wear Guarantee	Roll Price (£/m <sup>2</sup> )	Cut Price (£/m <sup>2</sup> )
● <b>Hospi Classic Heathers</b> Cut pile - 100% polypropylene	4	900	Impervious gel	10 Years	£12.41	£13.49
● <b>New Andaman</b> Cut pile - 100% polypropylene	4	700	Impervious gel	10 Years	£12.95	£14.03
● <b>Universal Heathers Gel</b> Cut pile - 100% polypropylene	4	1100	Impervious gel	10 Years	£14.79	£16.19
<b>Universal Lite</b> Cut pile - 100% polypropylene	4	1050	Impervious foam	10 Years	£19.99	£21.99
<b>Universal Tones</b> Cut pile - 100% polypropylene	4	1050	Impervious foam	10 Years	£19.99	£21.99

- Price update

**NEW RANGES** COMING IN 2026

## Carpet tiles

	Tile Size (cm)	Pile Weight (g/m <sup>2</sup> )	Backing	Wear Guarantee	No. Tiles per Box / Split Box	Price (£/m <sup>2</sup> )
<b>Colour Foundation Collection</b>						
Loop Pile - 100% Econyl Solution Dyed Nylon	50 x 50	480	Back2back	10 Years	20 / No	£12.49
<b>Rimini</b>						
Loop Pile - 100% Polypropylene	50 x 50	390	Bitumen	5 Years	20 / No	£8.49
<b>Rimini Stripe</b>						
Loop Pile - 100% Polypropylene	50 x 50	390	Bitumen	5 Years	20 / No	£9.19
<b>● Sprint</b>						
Loop Pile - 100% Solution Dyed Nylon	50 x 50	550	Bitumen	10 Years	20 / No	£11.33
<b>Triumph Cut</b>						
Cut Pile - 100% Solution Dyed Nylon	50 x 50	800	Bitumen	10 Years	20 / No	£15.99
<b>Triumph Everyway</b>						
Loop Pile - 100% Solution Dyed Nylon	50 x 50	650	Bitumen	10 Years	20 / No	£15.99
<b>Triumph Loop</b>						
Loop Pile - 100% Solution Dyed Nylon	50 x 50	500	Bitumen	10 Years	20 / No	£11.69

## Luxury vinyl tile

	Pack Size	Size (mm)	Thickness (mm)	Wear Layer (mm)	Wear Guarantee	Price (£/m <sup>2</sup> )	Pallet (£/m <sup>2</sup> )
<b>Decotile 30</b>							
Heterogeneous PVC (Plank / Stone)	4.75m <sup>2</sup> / 4.86m <sup>2</sup>	180 x 1200 / 300 x 600	2.0	0.30	7 Years	£11.99	£9.99
<b>Decotile 55</b>							
Heterogeneous PVC (Plank / Stone)	3.89m <sup>2</sup> / 3.96m <sup>2</sup>	180 x 1200 / 300 x 600	2.5	0.55	10 Years	£14.99	£11.99
<b>Harmony Tranquility / Unity</b>							
Heterogeneous PVC	3.76m <sup>2</sup> / 3.76m <sup>2</sup>	76.2 x 228.60 / 114.30 x 457.20	2.5	0.55	10 Years	£17.99	£14.99
<b>New Harmony</b>							
Heterogeneous PVC (Plank / Stone)	3.89m <sup>2</sup> / 3.96m <sup>2</sup>	180 x 1200 / 300 x 600	2.5	0.55	10 Years	£15.99	£13.49

● Price update

**NEW RANGES** COMING IN 2026

## Bespoke logo mat

	Width (m)	Pile Weight (g/m <sup>2</sup> )	Pile Height (mm)	Price
<b>Brush Logo Mat</b> Rib – 100% Polypropylene	Bespoke	1,700	13	POA
<b>Coir Logo Mat</b> 100% Coir	Bespoke	2,000	17	POA
<b>PVC Ramp Edge</b> Ramp edge for bespoke logo mats	Bespoke	N/A	N/A	POA

Whilst orders for smaller mats can be taken, the minimum charge would be for 1m<sup>2</sup>.

## Entrance matting sheet

	Width (m)	Pile Weight (g/m <sup>2</sup> )	Backing	Wear Guarantee	Roll Price (£/m <sup>2</sup> )	Cut Price (£/m <sup>2</sup> )
<b>Arizona II Sheet</b> Cut Pile - 100% Nylon	2	830	PVC	10 Years	£33.91	£37.09
<b>Geneva</b> Needlefelt Rib - 80% Polypropylene/20% Polyester	2	1150	Contract Gel	5 Years	£11.44	£12.71
<b>Zermatt Hobnail</b> Needlefelt - 80% Polypropylene/20% Polyester	2	1200	Contract Gel	8 Years	£12.71	£13.24
<b>Zermatt Wave</b> Needlefelt - 80% Polypropylene/20% Polyester	2	1200	Contract Gel	8 Years	£12.71	£13.24

## Entrance matting tiles

	Tile Size (cm)	Pile Weight (g/m <sup>2</sup> )	Backing	Wear Guarantee	No. Tiles per Box / Split Box	Price (£/m <sup>2</sup> )
<b>Arizona II</b> Cut Pile - 100% Nylon	50 x 50	830	Bitumen	10 Years	20 / No	£27.34
<b>Zermatt Hobnail Tile</b> Needlefelt - 80% Polypropylene/20% Polyester	50 x 50	1200	Bitumen	8 Years	20 / No	£16.42

**NEW RANGES** COMING IN 2026

# lifestyle FLOORS

Display discount now

7.5%\*

Love every step.

RETAILER  
EXCLUSIVE



Lifestyle Floors products  
are available to purchase by  
**independent retailers only**

Carpet

Display discount now

7.5%\*

Range Name		Description	Colours	Width	Backing	List rolls	List cuts	**On Display/ List cuts
						£M <sup>2</sup>	£M <sup>2</sup>	£M <sup>2</sup>
Adoro		Polyester saxony	10	4 & 5m	Duplex fleece back	14.61	16.86	15.59
Banquet	Check stock	Polypropylene saxony	12	4 & 5m	Action bac	11.56	12.85	11.89
Belle		Soft polyester	12	4 & 5m	Duplex backing	10.06	12.43	11.49
Canterbury Extra		Polypropylene saxony	17	4 & 5m	Action bac	7.01	8.95	8.28
Canterbury		Polypropylene saxony	8	4 & 5m	Action bac	7.01	8.95	8.28
Cosmic Twist		Polypropylene twist	12	4 & 5m	Action bac	13.32	15.55	14.38
Cottage Berber		Loop pile 100% wool berber	14	4 & 5m	Action bac	10.79	12.95	11.98
Divine Decadence	Check stock	Polypropylene saxony	12	4 & 5m	Duo backing	12.41	13.49	12.48
Ellsworth Super		100% polyester	14	4 & 5m	Fusion bac	10.65	13.70	12.67
Ellsworth Elite		100% polyester	14	4 & 5m	Fusion bac	12.29	14.75	13.64
Grantham		Polypropylene saxony	12	4 & 5m	Action Bac	6.79	8.63	7.98
Hereford		100% wool loop	24	4 & 5m	Action bac	12.99	14.99	13.87
Iridescence Sparkle		Polypropylene saxony with Lurex	9	4 & 5m	Action bac	10.54	12.62	11.67
Iridescence Pure		Polypropylene plain saxony	9	4 & 5m	Action bac	10.54	12.62	11.67
Jupiter Twist Super	Check stock	Polypropylene twist	16	4 & 5m	Action bac	5.84	8.17	7.56
Jupiter Twist Elite	Check stock	Polypropylene twist	16	4 & 5m	Action bac	8.53	10.87	10.05
Jupiter Twist Exclusive	Check stock	Polypropylene twist	16	4 & 5m	Action bac	10.40	12.04	11.13
Literature Elite	Check stock	Polypropylene twist	12	4 & 5m	Action bac	6.43	8.89	8.23
Literature Exclusive	Check stock	Polypropylene twist	12	4 & 5m	Action bac	9.34	11.06	10.23
Ludlow		Polypropylene twist	14	4 & 5m	Action bac	5.59	7.79	7.20
Maypole		Polypropylene twist	12	4 & 5m	Action bac	5.84	7.79	7.20
Molto Bella	Check stock	Polypropylene soft saxony	16	4 & 5m	Action bac	18.12	21.52	19.90
Montego Bay	Check stock	Polypropylene saxony	12	4 & 5m	Action bac	17.89	19.87	18.38
Pebble Beach Super		Fine polypropylene twist	18	4 & 5m	Action bac & felt back	4.63	7.01	6.48
Pebble Beach Elite		Fine polypropylene twist	18	4 & 5m	Action bac	7.01	8.95	8.28
Pebble Beach Luxury		Fine polypropylene twist	18	4 & 5m	Action bac	8.63	10.79	9.98
Rolling Hills		50/50 wool/PES loop chevron	8	4 & 5m	Action bac	14.03	16.73	15.47
Sandy Springs		50/50 wool/PES loop berber	6	4 & 5m	Action bac	9.99	11.49	10.63
Summit Twist Super		80/20 wool/polyester	12	4 & 5m	Action bac	11.99	13.99	12.94
Summit Twist Elite		80/20 wool/polyester	12	4 & 5m	Action bac	13.99	15.99	14.79
Summit Twist Exclusive		80/20 wool/polyester	12	4 & 5m	Action bac	14.99	18.19	16.83
Wilmslow	Check stock	Polypropylene velvet	18	4 & 5m	Action bac	10.79	12.95	11.98

\*'On display' list cuts include a 7.5% display discount for ranges installed on Lifestyle Floors displays. Pattern books and non-displayed ranges do not qualify.

● Price update



INDEPENDENT RETAILER  
EXCLUSIVE PRODUCTS

Vinyl

Display discount now

7.5%\*

Range Name		Description	Colours	Widths	List rolls	List cuts	**On Display' List cuts
					£M²	£M²	£M²
Baroque		2.8mm/0.20mm wear layer, cushion backing	15	2, 3 & 4m	5.70	10.04	9.28
Boho Bliss		2.5mm/0.25mm wear layer, textile backing	12	2, 3 & 4m	10.58	12.80	11.84
Columbia		2.0mm/0.25mm wear layer, textile backing	13	2, 3 & 4m	5.71	10.39	9.61
DenverTex	Check stock	3.8mm/0.40mm wear layer, textile backing	12	2, 3 & 4m	7.99	10.59	9.80
Essentials		4.0mm/0.25mm wear layer, cushion backing	16	2, 3 & 4m	5.80	11.20	10.36
GeorgiaTex		2.5mm/0.25mm wear layer, textile backing	11	2, 3, 4 & 5m	6.66	10.05	9.30
Harlem		2.6mm/0.25mm wear layer, cushion backing	17	2, 3 & 4m	3.78	8.96	8.29
Harlem Home		2.5mm/0.15mm wear layer, cushion backing	13	2, 3 & 4m	4.63	10.02	9.27
HarlemTex		2.5mm/0.15mm wear layer, textile backing	12	2, 3 & 4m	4.50	11.12	10.29
QueensTex		2.0mm/0.20mm wear layer, textile backing	12	2, 3 & 4m	5.60	8.98	8.31
San Diego		3.0mm/0.35mm wear layer, cushion backing	14	2, 3 & 4m	7.94	12.28	11.36
SilverTex		2.5mm/0.30mm wear layer, textile backing	15	2, 3 & 4m	6.35	9.84	9.10
South BeachTex		2.8mm/0.40mm wear layer, textile backing	11	2, 3 & 4m	9.52	11.21	10.37

\* 'On display' list cuts include a 7.5% display discount for ranges installed on Lifestyle Floors displays. Pattern books and non-displayed ranges do not qualify.

Laminate

Display discount now

7.5%\*

Range Name	Description	Colours	Pack Size M²	Planks per pack	Pallet £M²	Packs per pallet	Pack		†'On display' Pack	
							£M²	£Pack	£M²	£Pack
Chelsea	8mm 4V laminate, Class 32/AC4	8	2.179	9	6.85	52	9.48	20.67	8.77	19.12
Chelsea Extra	8mm 4V laminate, Class 32/AC4	8	2.179	9	6.85	52	9.48	20.67	8.77	19.12
Harrow	8mm 4V register embossed laminate, Class 32/AC4	10	1.994	8	6.99	60	11.99	23.92	11.09	22.12
Love AQUA®	8mm 4V water and stain-resistant, Class 32/AC4	8	2.179	9	11.59	52	14.23	31.01	13.16	28.69
Love AQUA® Steam	8mm 4V pressed bevel, water-resistant, steam cleanable laminate, Class 32/AC4	8	2.179	9	13.18	52	15.81	34.46	14.63	31.88

\* 'On display' pack prices include a 7.5% display discount for ranges installed on Lifestyle Floors displays. Pattern books and non-displayed ranges do not qualify.



INDEPENDENT RETAILER  
EXCLUSIVE PRODUCTS



Display discount now

7.5%\*

Range Name	Description	Colours	Pack Size M <sup>2</sup>	Tile/Plank Size	Tiles per Pack	Pallet			**On display/ Pack	
						£M <sup>2</sup>	£M <sup>2</sup>	£Pack	£M <sup>2</sup>	£Pack
Colosseum Dryback	2.5mm dryback LVT with a 0.55mm wear layer and 4V microbevel	17	7" Plank 3.25	1219mm (l) x 177mm (w)	15	12.99†	15.82	51.42	14.63	47.56
		1	9" Plank 3.34	1219mm (l) x 228mm (w)	12	12.99†	15.82	52.84	14.63	48.88
		3	Tile 3.34	609mm (l) x 304mm (w)	18	12.99†	15.82	52.84	14.63	48.88
Colosseum 5G Clic	5mm 5G Clic LVT with a 0.55mm wear layer and 4V microbevel	17	7" Plank 1.66	1213mm (l) x 171mm (w)	8	17.99†	21.10	35.03	19.52	32.40
		1	9" Plank 2.15	1213mm (l) x 222mm (w)	8	17.99†	21.10	45.37	19.52	41.96
		3	Tile 1.80	603mm (l) x 298mm (w)	10	17.99†	21.10	37.98	19.52	35.13
Colosseum XL‡ Dryback	2.5mm dryback LVT with a 0.55mm wear layer and a 4V microbevel	5	9" Plank 3.46	1516mm (l) x 228mm (w)	10	12.99†	15.82	54.74	14.63	50.63
		1	Large Tile 3.763	914mm (l) x 457mm (w)	9	12.99†	15.82	59.53	14.63	55.07
Colosseum XL‡ 5G Clic	5mm 5G Clic LVT with a 0.55mm wear layer and 4V microbevel	5	9" Plank 2.01	1516mm (l) x 228mm (w)	10	17.99†	21.10	42.41	19.52	39.23
		1	Large Tile 1.636	908mm (l) x 450mm (w)	9	17.99†	21.10	34.52	19.52	31.93
Galleria	2mm dryback LVT with a 0.3mm wear layer	8	7" Plank 4.33	1219mm (l) x 177mm (w)	20	9.49†	11.07	47.93	10.24	44.34

\* 'On Display' pack prices include a 7.5% display discount for ranges installed on Lifestyle Floors displays. Pattern books and non-displayed ranges do not qualify.

† Pallet prices apply to orders of a single colour over 100m<sup>2</sup> (nearest pack equivalent).

‡ This range is made up of 7 existing (9" Plank) décors previously known as Palace and 3 existing (Large Tile) décors taken from the Colosseum range. The product remains the same.



INDEPENDENT RETAILER  
EXCLUSIVE PRODUCTS

## Price increase effective from 1 April 2026

### Altro flooring

Product	Gauge MM	Roll Width M	£M <sup>2</sup> Cuts 1-39	£M <sup>2</sup> Rolls 40-199	£M <sup>2</sup> 5 Rolls 200-399	£M <sup>2</sup> 10 Rolls 400+
<b>Altro safety flooring</b>						
Altro Suprema™	2.0	2	32.75	28.48	27.54	26.96
Altro Aquarius™	2.0	2	24.50	20.91	22.67	22.23
Altro Pisces™	2.0	2	24.50	20.91	22.67	22.23
Altro Wood™ adhesive-free	2.4	2	30.47	19.35	-	-
Altro Wood™	2.0	2	27.78	17.41	-	-
Altro Wood™ Comfort	2.85	2	22.17	19.21	-	-
Altro Illustra™	2.0	2	27.93	23.27	-	-
Altro Illustra™ adhesive-free	2.4	2	30.63	25.96	-	-
Altro ContraX™	2.0	2	13.48	9.91	-	-
Altro Walkway™ 20	2.0	2	22.97	11.22	19.32	18.92
Altro Walkway™ 20SD (Static Dissipative)	2.0	2	38.04	33.08	32.01	31.32
Altro Marine™ 20	2.0	2	31.06	27.11	26.23	25.72
Altro Classic™ 25	2.5	2	39.86	34.66	33.50	32.81
Altro Reliance™ 25	2.5	2	39.86	34.66	33.50	32.81
Altro XpressLay™	2.2	2	20.85	17.26	-	-
Altro Stronghold™ 30*	3.0	2	47.66	41.42	39.97	39.24
Altro Stronghold™ 30 adhesive-free*	3.0	2	52.42	45.56	43.97	43.15
Altro Atlas™ 40**	4.0	2	58.03	50.47	48.02	47.08

N.B. promotional prices above.

\* £M<sup>2</sup> Cuts 1-29, £M<sup>2</sup> Rolls 30-149, £M<sup>2</sup> 5 Rolls 150-299, £M<sup>2</sup> 10 Rolls 300+. \*\* £M<sup>2</sup> Cuts 1-24, £M<sup>2</sup> Rolls 25-124, £M<sup>2</sup> 5 Rolls 125-249, £M<sup>2</sup> 10 Rolls 300+.

### Altro smooth flooring

			1-39	40-199		
Altro Orchestra™	2.85	2	24.66	20.87	-	-
Altro Orchestra™ Custom	2.85	2	-	57.52	-	-
Altro Operetta™	2.0	2	23.56	19.77	-	-
Altro Serenade™	3.9	2	26.51	22.72	-	-
Altro Cantata™ adhesive-free	2.2	2	28.28	23.93	-	-

### Altro Ensemble™ Modular Flooring System

Plank/tile size (W x L)	No. of colours	Box volume	Price per sqm	Box price
Wood 125mm x 1000mm	24	5m <sup>2</sup> (40 planks)	34.78	173.90
Wood 100mm x 500mm	10	5m <sup>2</sup> (100 planks)	34.78	173.90
Wood 166mm x 1500mm	5	5m <sup>2</sup> (20 planks)	34.78	173.90
Wood 200mm x 2000mm	13	6m <sup>2</sup> (15 planks)	34.78	208.68
Stone 500mm x 500mm	10	5m <sup>2</sup> (20 tiles)	34.78	173.90
Stone 500mm x 1000mm	10	5m <sup>2</sup> (10 tiles)	34.78	173.90

### Surface damp proof membranes

Product	Size	£ per m <sup>2</sup>	£ Per Unit
Altroproof Solo fast-track™ variant	6kg	6.75	121.48
Altroproof Solo standard™ variant	6kg	4.58	82.34

### Underlay

Product	Gauge MM	Roll Width	Roll Length	£M <sup>2</sup> 1-99m <sup>2</sup>	£M <sup>2</sup> 100+m <sup>2</sup>
Altro Everlay™ A	1.2	2M	50M	19.92	17.28
Altro Everlay™ B	4.0	2M	25M	34.10	29.52
Altro Acoustic™ Underlay 1101	3.0	1.15M	36M	403.19 per roll	



# 2026 TRADE PRICE LIST

SKU	PRODUCT	DESCRIPTION	PACK SIZE	TRADE PRICE
<b>FLOORING ADHESIVES</b>				
38361	ARDEX AF 145	Pressure Sensitive & Wet Set Vinyl Flooring Adhesive	12KG*	£77.39
39324	ARDEX AF 148	Pressure Sensitive Contract Adhesive	10KG	£77.39
38357	ARDEX AF 165	Vinyl Flooring Adhesive	14KG	£85.18
38359	ARDEX AF 175	Luxury Vinyl Tile Flooring Adhesive	12KG*	£77.39
46767	ARDEX AF 195	High Temperature LVT Adhesive	12KG*	£87.34
38358	ARDEX AF 325	Low Emission Carpet Adhesive	14KG	£52.84
38366	ARDEX AF 825	Surface Tackifier	10KG	£73.26
39322	ARDEX AF 835	High Grab Tackifier	10KG	£78.56
38840	ARDEX AF 2575 PLUS	One Component Heavy Duty Flooring Adhesive	7KG	£90.31
<b>LEVELLING &amp; SMOOTHING COMPOUNDS</b>				
18288	ARDITEX NA (POWDER)	Rapid Setting SubFloor Levelling & Smoothing Compound	20KG	£11.74
44879	ARDITEX NA (LATEX)		4.95KG	£23.89
22813	ARDITEX CL (POWDER)	Two-Part Levelling & Smoothing Compound	20KG	£7.89
22812	ARDITEX CL (LATEX)		4.5KG	£13.86
44882	ARDITEX CL PLUS (POWDER)	Fibre Reinforced Moisture Tolerant Levelling & Smoothing Compound	20KG	£20.11
44881	ARDITEX CL PLUS (LATEX)		4.8KG	£9.88
38990	ARDEX K 40 HB	Fibre Reinforced High Build Levelling & Smoothing Compound	22KG	£19.76
38989	ARDEX K 40 FLOW	High Flow Levelling & Smoothing Compound	22KG	£29.24
40891	ARDEX K 55 FAST	Ultra Rapid Drying Levelling & Smoothing Compound	20KG	£29.65
<b>EXTERIOR LEVELLING COMPOUNDS &amp; WEARING SURFACES</b>				
18462	ARDEX K 301	Exterior Self-Smoothing Levelling and Resurfacing Compound	25KG	£53.63
44345	ARDEX K 71	Rapid Drying Industrial Topping and Wearing Surface	25KG	£33.52
<b>PRIMERS &amp; DAMP PROOF MEMBRANES</b>				
18468	ARDEX P 51	Concentrated Water Based Primer and Bonding Agent	5KG*	£48.74
18477	ARDEX P 4	Ready Mixed Rapid Drying Multi-Purpose Primer	8KG	£77.13
18443	ARDEX R 3 E	Moisture Tolerant Epoxy Primer	6KG*	£135.98
22602	ARDEX MVS 95	Ready Mixed Moisture Vapour Suppressant	12KG	£172.33
18299	ARDEX DPM 1 C	One Coat Surface Damp Proof Membrane	10KG*	£248.55
<b>REPAIR MORTARS</b>				
18279	ARDEX FEATHER FINISH	Rapid Drying Patching and Smoothing Compound	11KG*	£59.25
18296	ARDEX ARDURAPID A 45	Rapid Drying and Hardening Internal Repair Mortar	11KG	£23.64
18297	ARDEX A 46	Rapid Setting and Hardening External Repair Mortar	11KG*	£28.48
25100	ARDEX P 10 SR	Rapid Hardening Crack Repair Kit (6 kits in 1 box)	6 x 660ML	£207.78
<b>AGGREGATES</b>				
18294	ARDEX COARSE AGGREGATE	3mm Single Sized Graded Coarse Aggregate	25KG	£11.26
18428	ARDEX FINE AGGREGATE	1 to 1.5mm Graded Fine Aggregate	25KG	£15.24

\*Product available in various sizes. Contact the trade counter for more information on ARDEX products.



## THE APP THAT REWARDS YOUR ARDEX PURCHASES WITH CASH!

## GIUBAX REWARDS



MORE FROM WOOD.



# Flooring Collection 25+

EGGER	Thickness	Suitability	Water Resistant	Plank size w x l	Packs per Pallet	Pack £m2	Pallet £m2	Stand holder
NATURE SENSE AQ 8	8mm	AC4	24hrs	Classic -193 x 1292mm	60	11.73	10.04	10.85
				Medium - 135 x 1292mm	75			
NATURE SENSE AQ 10	10mm	AC4	24hrs	193 x 1292mm	52	13.43	11.63	12.42
NATURE SENSE AQ+32	8mm	AC4	72hrs	193 x 1292mm	60	15.22	13.74	14.08
NATURE SENSE AQ+33	8mm	AC5	72hrs	Classic -193 x 1292mm	60	15.22	13.74	14.08
				Large - 246 x 1292mm	45			
NATURE SENSE HB	8mm	AC4	-	168 x 840mm	49	16.92	14.27	15.65
NATURE SENSE KING (Chevron)	8mm	AC4	-	327 x 1292mm	40	14.80	12.16	13.69

## Adhesives



F. Ball and Co. Ltd.

Product	General Use	Size	Approximate Coverage per unit		Price per unit
<b>Styccobond F1</b>	Latex Adhesive for Edge Sealing	5ltr			32.25
<b>Styccobond F3</b>	Carpet Adhesive	15ltr	45m <sup>2</sup>		60.99
		5ltr	15m <sup>2</sup>		23.39
<b>Styccobond F30</b>	Carpet Seaming Adhesive	500ml	50 linear metres		11.85
<b>F30 Dispenser</b>	Dispenser Bottle				2.24
<b>Stycco Seal</b>	Silicone Sealant (Translucent, White or Black)	310ml	11 linear metres @ 6mm bead		9.27
<b>Stycco Flex</b>	Rapid Curing Flexible Adhesive	290ml	14 linear metres @ 5mm bead		8.41
<b>Styccobond F40</b>	Hi-Tack Release for Carpet/Underlay	15ltr	1.5 x 5mm = 81m <sup>2</sup>		107.72
		5ltr	1.5 x 5mm = 27m <sup>2</sup>		37.65
<b>Styccobond F41</b>	Carpet Tile Tackifier	20ltr	Roller = 160 - 440m <sup>2</sup>		128.63
		15ltr	Roller = 120 - 330m <sup>2</sup>		98.84
		5ltr	Roller = 40 - 110m <sup>2</sup>		32.83
<b>Styccobond F44</b>	Vinyl and PVC Backed Carpet Adhesive	15ltr	1.5 x 5mm = 60m <sup>2</sup>		78.66
		5ltr	1.5 x 5mm = 20m <sup>2</sup>		29.33
<b>Styccobond F45</b>	For Highly Plasticised PVC Backed Carpets and Flexible PVC Floorcoverings	15ltr	A2 = 60m <sup>2</sup>	1.5 x 5mm = 60m <sup>2</sup>	81.79
		5ltr	A2 = 20m <sup>2</sup>	1.5 x 5mm = 20m <sup>2</sup>	29.83
<b>Styccobond F46</b>	Pressure Sensitive Adhesive for Vinyl Floorcoverings	15ltr	1.5 x 5mm = 75m <sup>2</sup>	A2 = 45m <sup>2</sup> A1 / Finenotch = 60m <sup>2</sup>	97.99
		5ltr	1.5 x 5mm = 25m <sup>2</sup>	A2 = 15m <sup>2</sup> A1 / Finenotch = 20m <sup>2</sup>	34.86
<b>Styccobond F47</b>	Pressure Sensitive Adhesive for use over Isolator Membrane	15ltr	A1 = 45m <sup>2</sup>	1.5 x 5mm and Paint roller 75m <sup>2</sup>	94.32
<b>Styccobond F48 PLUS</b>	High Temperature Vinyl Adhesive	15ltr	A2 / 1.5 x 5mm = 60m <sup>2</sup>		92.03
		5ltr	A2 / 1.5 x 5mm = 20m <sup>2</sup>		36.37
<b>Styccobond F49 HYBRID PS</b>	Temperature Tolerant Pressure Sensitive Adhesive	5kg	A1 / Finenotch = 30m <sup>2</sup>		62.89
		2kg	A1 / Finenotch = 12m <sup>2</sup>		31.55
<b>Styccobond F54</b>	High Grab Linoleum Adhesive	15ltr	2 x 6mm = 45m <sup>2</sup>		66.84
<b>Styccobond F57</b>	Conductive Acrylic Adhesive	15ltr	2 x 6mm = 60m <sup>2</sup>		131.78
<b>Styccobond F58 PLUS</b>	Fibre-Reinforced Vinyl & Rubber Adhesive	15ltr	A2 = 90m <sup>2</sup>		111.87
		5ltr	A2 = 30m <sup>2</sup>		39.15
<b>Styccobond F60</b>	Contact Adhesive	5ltr	Safety Spreader = 10m <sup>2</sup> (coating both surfaces)		41.99
<b>Styccobond F61</b>	Heavy-Duty Contact Adhesive	5ltr	Safety Spreader = 10m <sup>2</sup> (coating both surfaces)		45.27
<b>Styccobond F66</b>	Solvent Free Water based Contact Adhesive	5ltr	1.4 x 2.5mm = 25m <sup>2</sup> per coat Brush = 45m <sup>2</sup> per coat		48.01
<b>Styccobond F73 PLUS</b>	One Part Heavy Duty Flooring Adhesive	7.5kg	A2 = 24.75m <sup>2</sup> 2 x 6mm = 19.5m <sup>2</sup> 3 x 6mm = 13.5m <sup>2</sup>		89.78
<b>Styccobond F81</b>	Epoxy Adhesive	5kg Kit			74.90
<b>Styccobond F84</b>	Two Part Flooring Adhesive for use over Isolator Membrane	5kg kit	1.5 x 5mm = 15m <sup>2</sup> 2 x 6mm = 10m <sup>2</sup>		53.72
		2kg kit	1.5 x 5mm = 6m <sup>2</sup> 2 x 6mm = 4m <sup>2</sup>		25.33
<b>Styccobond B95</b>	Flexible Wood Flooring Adhesive	15kg	3 x 6mm = 18.75m <sup>2</sup> B11 = 15m <sup>2</sup>		106.84
		8kg	3 x 6mm = 10m <sup>2</sup> B11 = 8m <sup>2</sup>		59.88
Foil Sausage (requires Applicator Gun)		1kg	1.0m <sup>2</sup> -2.0m <sup>2</sup> applied at 125-250mm centres		6.64

For Further Details Please Visit  
[www.f-ball.com](http://www.f-ball.com)  
 or contact our Technical Service Department on  
 01538 361633



**The UK's Market Leading Range  
of High Performance Flooring Adhesives  
and Subfloor Preparation Products**

## Floor Preparation







Product	General Use	Size	Approximate Coverage per unit	Price per unit
<b>Stopgap Red Bag</b>	Light-Duty Smoothing Compound	25kg	4.8m <sup>2</sup> @ 3mm	20.08
<b>Stopgap Green Bag</b>	General Purpose Smoothing Compound (use with 114/128 Liquid)	25kg	5m <sup>2</sup> @ 3mm	8.28
<b>Stopgap 128 Liquid</b>	Absorbent Surfaces	5ltr		13.55
<b>Stopgap 114 Liquid</b>	Absorbent/Non-Absorbent Surfaces	5ltr		15.90
<b>Stopgap Fast-Track 30</b>	Rapid Set/Rapid Dry Compound	16kg	5.6m <sup>2</sup> @ 2mm	31.50
<b>Stopgap 300</b>	Heavy Duty Smoothing Compound	25kg	5.0m <sup>2</sup> @ 3mm (unfilled) / 1.3m <sup>2</sup> @ 15mm (filled)	25.70
<b>Stopgap 400</b>	Rapid Repair Compound	10kg	Eco Pouch	13.65
<b>Stopgap 460</b>	Rapid Repair Mortar for External Floors	10kg	1 Bucket covers 2.3m <sup>2</sup> @ 3mm	21.70
<b>Stopgap 500</b>	Floor Finishing Compound	8kg	Micro-Coat Eco Pouch	29.60
<b>Stopgap MICRO RAPID</b>	Floor Finishing Compound	8kg	Eco Pouch	38.21
<b>Stopgap 600</b>	Deep Section Compound	25kg	2.8m <sup>2</sup> @ 5mm	21.14
<b>Stopgap 700</b>	Flexible, Fibre Reinforced Smoothing Compound	20kg	4.8m <sup>2</sup> @ 3mm	41.85
<b>Stopgap 800</b>	Self-Levelling Wearing Surface	25kg	3m <sup>2</sup> @ 5mm	44.53
<b>Stopgap SEAL</b>	For use with Stopgap 800	5ltr	50m <sup>2</sup>	89.62
<b>Stopgap 850</b>	Exterior Grade Smoothing and Resurfacing Compound	25kg	2.9m <sup>2</sup> @ 5mm (unfilled mix)/0.4m <sup>2</sup> @ 50mm (filled mix)	38.44
<b>Stopgap 1100</b>	Calcium Sulphate based Smoothing Compound	22kg	5m <sup>2</sup> @ 2-3mm	26.74
<b>Stopgap 1200</b>	High Performance Smoothing Compound	20kg	5m <sup>2</sup> @ 2-3mm	12.61
<b>Stopgap 1400</b>	High Flow Smoothing Compound <b>NEW</b>	20kg	5.9m <sup>2</sup> @ 2mm	9.09
<b>Stopgap 1500</b>	High Performance Water Mix Smoothing Compound	20kg	5m <sup>2</sup> @ 2-3mm	27.64
<b>Stopgap 1600</b>	Fibre Reinforced Smoothing Compound <b>NEW</b>	20kg	3.7m <sup>2</sup> @ 3mm / 0.7m <sup>2</sup> @ 15mm / 0.4m <sup>2</sup> @ 25mm / 0.25m <sup>2</sup> @ 40mm	19.00
<b>Stopgap 1200 Liquid</b>	Use with Stopgap 1200 Powder	5ltr		15.13
<b>Stopgap 1400 Liquid</b>	Use with Stopgap 1400 Powder	4.5ltr		10.80
<b>Stopgap GRADED AGGREGATE</b>	3mm for use with Filled Mixes	25kg		10.50
<b>Stopgap P121</b>	Acrylic Primer	5ltr	50m <sup>2</sup> depending on absorbency	20.85
<b>Stopgap P131</b>	General Purpose Primer	5ltr	50m <sup>2</sup> (neat) 100m <sup>2</sup> (diluted)	40.27
		2.5ltr	25m <sup>2</sup> (neat) 50m <sup>2</sup> (diluted)	22.16
<b>Stopgap P141</b>	Primer for Non-Absorbent Floors	5ltr	65m <sup>2</sup> neat	42.71
<b>Stopgap Fill and Prime</b>	Flexible Cement Based Primer	6.6kg Kit	20m <sup>2</sup> per unit @ 0.2mm thickness	27.23
<b>Stopgap SRS</b>	Surface Reinforcement System	5kg	1 - 1.7m <sup>2</sup>	110.48
		10kg	2 - 3.4m <sup>2</sup>	211.20
<b>Stopgap F77</b>	High Performance Waterproof Surface Membrane (1 coat)	14kg kit	25m <sup>2</sup> up to 98% RH or 90% with underfloor heating - 35m <sup>2</sup> up to 85% RH	179.56
	7kg kit		12.5m <sup>2</sup> up to 98% RH or 90% with underfloor heating - 17.5m <sup>2</sup> up to 85% RH	95.03
		3kg kit	5.5m <sup>2</sup> up to 98% RH or 90% with underfloor heating - 7.5m <sup>2</sup> up to 85% RH	49.74
<b>Stopgap F78</b>	One Component Waterproof Surface Membrane (2 coat)	18kg bottle	60m <sup>2</sup> up to 95% RH	260.44
		12kg bottle	40m <sup>2</sup> up to 95% RH	179.11
		6kg bottle	20m <sup>2</sup> up to 95% RH	94.52
<b>Isolator Membrane</b>	Loose lay, Impervious Laminated Sheet	2m x 20m	40m <sup>2</sup>	727.14
<b>Jointing Tape</b>	Use with Isolator Membrane	50mm x 50m	Roll	20.13

### Accessories







Product	General Use	Size	Price per unit
<b>Impact Tape</b>	Contact Adhesive Tape (Double Sided)	25mm x 50m	19.97
<b>Spiked Roller</b>	400mm wide (complete with Telescopic Handle)	50mm x 50m	36.20
<b>Digital Hygrometer</b>	Determines Moisture Content in Floors	85mm x 50m	59.65
<b>Tramex Meter</b>	Tramex CMEX5 Flooring Installers EZ Kit		156.77
<b>Protimeter Aquant™</b>	Moisture Meter		1051.77
<b>Mixing Bucket</b>	For mixing STOPGAP Smoothing Compound	25ltr	10.79
<b>Measuring Bucket</b>	For use with Water Mix Smoothing Compound		5.45
<b>Smoothing Trowel</b>	Pointed	400mm x 115mm	15.66
<b>Smoothing Trowel</b>	Standard	280mm x 115mm	14.22
<b>Power Whisk</b>	For use with Electric Drill	80mm dia (standard) MR2	11.47
<b>Paint Roller</b>	Applying Sealers and Primers	100mm dia (large) MR3	13.00
<b>Styccodean C140</b>	Applying Sealers and Primers	Complete - Frame, Felt Roller and Telescopic Handle	32.10
<b>Stycco-Clean C140</b>	Contaminants Remover eg. Grease/Polish	5ltr	21.09
<b>Stycco-Wipes</b>	Multi-Purpose Cleaning Wipes	100 wipes	18.91
<b>'V' Notched Trowel</b>		2 x 6mm, 1.5 x 5mm, 1.5 x 1.5mm, 3 x 6mm	14.22
<b>Styccobond F66 Applicator Sponges</b>		(pack of 2)	3.41
<b>Applicator Gun</b>	For Stycco Flex and Seal Cartridges		9.17
<b>Scuttle</b>	For cleaning Spiked Rollers & Roller Applied Adhesives		11.47









## Safety Flooring

Product Name	Code	Product Specification	Thickness (mm)	Packaging	Surface Treatment	Warranty	List Price (£/m <sup>2</sup> )
Tarasafe Standard	HB63	 2m wide	2	20 lm per roll	SparClean®	12	20.77
Tarasafe H <sub>2</sub> O	HD29	 2m wide	2	20 lm per roll	SparClean®	12	25.16
Tarasafe Ultra H <sub>2</sub> O	HB25	 2m wide	2	20 lm per roll	-	12	24.14
Tarasafe Ultra	H821	 2m wide	2	20 lm per roll	SparClean®	12	21.55
Tarasafe Impression	2404	 2m wide	2	25 lm per roll	Protecsol® Control	12	24.11
Tarasafe Plus	H820	 2m wide	2.5	20 lm per roll	-	12	23.36
Tarasafe Super	H811	 2m wide	2.2	20 lm per roll	-	12	30.84

## Multi Layered Flooring

Product Name	Code	Product Specification	Thickness (mm)	Packaging	Surface Treatment	Warranty	List Price (£/m <sup>2</sup> )
Nerok 70 Compact	1238	 2m wide	2	20 lm per roll	PUR+	12	21.16
Nerok 70 Compact	1237	 4m wide	2	20 lm per roll	PUR+	12	21.16
Nerok 55 Compact	2813	 2m wide	2	20 lm per roll	PUR+	12	19.80
Nerok 55 Compact	2812	 4m wide	2	20 lm per roll	PUR+	12	19.80
Taralay Initial Compact	2222	 2m wide	2	25 lm per roll	Protecsol®	12	15.95
Taralay Initial Acoustic	2215	 2m wide	3.35	25 lm per roll	Protecsol®	12	19.32

## Residential Flooring

Product Name	Code	Product Specification	Thickness (mm)	Packaging	Slip Resistance	Warranty	List Price (£/m <sup>2</sup> )
Griptex	1308	 2m wide	2.9	25 lm per roll	R10/+36 PTV	12	13.31
Griptex	1568	 3m wide	2.9	25 lm per roll	R10/+36 PTV	12	13.31
Griptex	1478	 4m wide	2.9	25 lm per roll	R10/+36 PTV	12	13.31
Texline	1349	 2m wide	2.9	25 lm per roll	R10	15	11.35
Texline	1619	 3m wide	2.9	25 lm per roll	R10	15	11.35
Texline	1519	 4m wide	2.9	25 lm per roll	R10	15	11.35

# GRADUS

## Secondary Barrier Matting (impervious sheet)

Range	Code	Construction	Yarn Brand	Backing	Roll Width	*Roll Length	Rolls (£m <sup>2</sup> )	Cut Length (£m <sup>2</sup> )
Boulevard 1500	<b>7055</b>	Needlepunch	100% Polypropylene	Rubber	2m	15m	32.59	<b>39.11</b>
Boulevard 5000	<b>7054</b>	Tufted Cut Pile	ECONYL® Regenerated SDN	Pvc	2m	25m	67.53	<b>81.05</b>
Boulevard 6000	<b>7053</b>	Tufted Cut Pile	ECONYL® Regenerated SDN	Pvc	2m	25m	78.81	<b>94.55</b>
Boulevard 7000	<b>7052</b>	Tufted Cut Pile	100% SDN	Pvc	2m	20m	83.71	<b>100.44</b>
Boulevard Stripe	<b>7051</b>	Tufted Cut Pile	ECONYL® Regenerated SDN	Pvc	2m	25m	78.81	<b>94.55</b>

\*Average roll length.

## FIBRE BONDED CARPETS & TILES

Product	Roll Width	Full Roll Length (Linear Metres)	Rolls (£/m <sup>2</sup> )	Cuts (£/m <sup>2</sup> )	Tile Size	Tiles Per Box	Tiles (£/m <sup>2</sup> )
Supacord	2m & 4m	30	11.78	15.31	50 x 50cm	20 (5m <sup>2</sup> )	18.68
Broadrib	2m & 4m	30	12.60	16.38	50 x 50cm	20 (5m <sup>2</sup> )	19.20
Wellington Velour	2m	30	13.26	17.24	50 x 50cm	16 (4m <sup>2</sup> )	19.80
Hobnail	2m	30	12.85	16.70	50 x 50cm	20 (5m <sup>2</sup> )	19.42
Iron Duke	2m & 4m	30	9.72	12.64	-	-	-
Array	-	-	-	-	50 x 50cm	16 (4m <sup>2</sup> )	21.49

## ACOUSTIC TILES

Product	Roll Width	Full Roll Length (Linear Metres)	Rolls (£/m <sup>2</sup> )	Cuts (£/m <sup>2</sup> )	Tile Size	Tiles Per Box	Tiles (£/m <sup>2</sup> )
Broadrib Acoustic Tiles	-	-	-	-	50 x 50cm	16 (4m <sup>2</sup> )	20.22
Supacord Acoustic Tiles	-	-	-	-	50 x 50cm	16 (4m <sup>2</sup> )	20.02

Please note, Acoustic Tiles are made to special order, with a minimum order quantity of 60 square metres.

## ENTRANCE & TRANSITION AREA CARPETS & TILES

Product	Roll Width	Full Roll Length (Linear Metres)	Rolls (£/m <sup>2</sup> )	Cuts (£/m <sup>2</sup> )	Tile Size	Tiles Per Box	Tiles (£/m <sup>2</sup> )
Battleship	2m & 4m	12	20.53	27.20	-	-	-
Hippo	2m & 4m	12	23.76	31.48	-	-	-
Dreadnought	2m	12	20.53	27.20	50 x 50cm	16 (4m <sup>2</sup> )	25.08
Vanquisher	2m	12	21.68	28.72	-	-	-
Diamond	2m	12	28.06	37.18	50 x 50cm	16 (4m <sup>2</sup> )	36.32
Zephyr	2m	12	25.83	34.22	50 x 50cm	16 (4m <sup>2</sup> )	34.16
Sticks and Stones	-	-	-	-	50 x 50cm	16 (4m <sup>2</sup> )	39.62

## ENTRANCE AREA LOOSE LAY MATS

Product	Size	Price*
Diamond & Hippo (All Colour Options)	0.91m x 0.61m	£106.00
	0.91m x 1.22m	£150.00
	1.22m x 1.83m	£217.00
Vanquisher (Charcoal & Deep Blue)	1.83m x 2.44m	£316.00
	0.91m x 3.04m	£274.00
	1.22m x 3.04m	£304.00

\*Special sizes available on request

## CLASSROOM LOOSE LAY MATS

Product	Size	Price*
Wellington Classroom Mat (Anthracite, Sapphire, Claret, Lincoln Green & Moonstone)	2m x 2m	£230.00
	3m x 2m	£284.00
	2m x 4m	£340.00
	3m x 3m	£384.00
	3m x 4m	£418.00
	4m x 4m	£450.00

\*Special sizes available on request

# Flooring Systems

Prices effective  
from Jan 2026

Laying Range

Adhesives, Primers, Smoothing Compounds, Varnishes, Protection, Detergents and Accessories

<b>Kerakoll products</b>	<b>Price</b>	<b>Size</b>	<b>Coverage</b>
<b>Smoothing compounds</b>			
Proflow Smooth	£28.05	20 + 5 kg	≈ 1.481 kg/m <sup>2</sup> per mm of thickness
Proflow MVS	£42.16	20 + 5 kg	≈ 1.333 kg/m <sup>2</sup> per mm of thickness
Proflow Rapid	£32.79	20 + 4.5 kg	≈ 1.481 kg/m <sup>2</sup> per mm of thickness
Proflow Trade	£20.65	20 + 4.5 kg	≈ 1.666 kg/m <sup>2</sup> per mm of thickness
Proflow Finish	£23.45	20 kg	≈ 1.481 kg/m <sup>2</sup> per mm of thickness
<b>Hardwood and resilient flooring primers</b>			
Primeplus 1 l	£8.20	1 l	≈ 1 l neat covers 10 m <sup>2</sup> - dilute with 3 parts water, 1 l covers 40 m <sup>2</sup> - applied as a slurry coat, 1 l covers 18 m <sup>2</sup>
Primeplus 5 l	£27.80	5 l	≈ 45 – 65 m <sup>2</sup> per 5 kg unit (depending on porosity of surface/substrate)
Prime+ Grip 1 kg	£12.08	1 kg	≈ 30 ml/m <sup>2</sup>
Prime+ Grip 5 kg	£43.60	5 kg	≈ 30 ml/m <sup>2</sup>
Keragrip Eco Pulep 10 l	£142.94	10 l	≈ 1.525 kg/m <sup>2</sup> per mm of thickness
Keragrip Eco Pulep 1 l	£16.39	1 l	≈ 1.525 kg/m <sup>2</sup> per mm of thickness
Quarzo 1.3	£15.72	25 kg	≈ 1.525 kg/m <sup>2</sup> per mm of thickness
Quarzo 5.12	£23.58	25 kg	≈ 1.525 kg/m <sup>2</sup> per mm of thickness
<b>Hardwood floor adhesives</b>			
L34 Hybrid Neutral	£167.68	16 kg	≈ 700 – 1300 g/m <sup>2</sup>
L34 Hybrid Light	£167.68	16 kg	≈ 700 – 1300 g/m <sup>2</sup>
L34 Evolution Rapid	£115.28	9.4 + 0.6 kg	≈ 800 – 1500 g/m <sup>2</sup>
<b>Hardwood floor varnishes and protection</b>			
Aqua-Pur Flex	£62.88	2x2 l	≈ 30 – 40 ml/m <sup>2</sup> per coats
Aqua-Pur Satin	£293.44	2x5 l	≈ 80 – 100 ml/m <sup>2</sup> per coats
Aqua-Pur Matt	£293.44	2x5 l	≈ 80 – 100 ml/m <sup>2</sup> per coats
<b>Hardwood floor accessories</b>			
Roller Plus Complete	£73.59	1 pc	
Roller Plus Spare	£47.40	1 pc	
Roller Classic Complete	£29.34	1 pc	
Roller Classic Spare	£20.96	1 pc	
Spreaders for hardwood-floors and resilient materials laying	£46.02	12 pcs.	
<b>Detergents</b>			
Supersoap	£6.60	4x1.5 l	
Refresher	£8.80	2x1.5 l	
<b>Tilemaster products</b>			
<b>Primers, additives and DPM</b>			
Fast One Coat DPM 3 kg	£102.46	3 kg	≈ when applied to a smooth surface using an A2 trowel a 3 kg unit will cover approx 7.5 m <sup>2</sup> - a 7 kg unit will cover up to approx 17.5 m <sup>2</sup> - a 14 kg unit will cover up to approx 35 m <sup>2</sup>
Fast One Coat DPM 7 kg	£187.73	7 kg	≈ 4.2 m <sup>2</sup> at 3 mm depth
Fast One Coat DPM 14 kg	£323.26	14 kg	
<b>Smoothing Compounds</b>			
FineFlow 3000	£18.22	20 kg	
<b>Rapid repair mortar and patch repair</b>			
Rapid Repair Mortar	£16.30	11 kg	≈ 7 m <sup>2</sup> at 1 mm depth - unfilled
Feather	£49.67	11 kg	≈ 10 m <sup>2</sup> at 1 mm depth
<b>Carpet and textile flooring adhesives</b>			
Eco 3000 HT	£96.54	15 kg	≈ 50 – 60 m <sup>2</sup>
Eco 3000 PS	£115.55	15 kg	≈ 80 – 90 m <sup>2</sup>
<b>Moisture hygrometer and buckets</b>			
Hygrometer	£161.39	1 pc	
Bucket Large 21 l	£7.11	1 pc	
Bucket Small 10 l	£4.44	1 pc	

**kerakoll**

Building Better Together

CODE	PRODUCT	SIZE	COVERAGE	PRICE
<b>SURFACE DAMP PROOF MEMBRANES</b>				
281550	MAPELAY	25M X 2M ROLL	50m <sup>2</sup>	£930.82
241104M / 241504M	MAPEPROOF ESM A / B	3KG / 1KG	20m <sup>2</sup> (2 coats)	£66.94 / £22.31
2821207 / 2821307	MAPEPROOF ONE COAT A / B	4.2KG / 2.8KG	16m <sup>2</sup> (97% RH)	£55.83 / £51.55
2821221 / 2821321	MAPEPROOF ONE COAT A / B	12.6KG / 8.4KG	48m <sup>2</sup> (97% RH)	£143.04 / £154.97
2822710	MAPEPROOF PRIMER	10KG	40m <sup>2</sup> (2 coats)	£139.00
<b>PRIMERS</b>				
1560105 / 1560110	ECO PRIM GRIP PLUS	5KG / 10KG	25m <sup>2</sup> / 50m <sup>2</sup>	£46.14 / £83.05
1558205 / 1558220	ECO PRIM T PLUS	5KG / 20KG	50m <sup>2</sup> (neat) / 200m <sup>2</sup> (neat)	£51.30 / £191.25
<b>SMOOTHING COMPOUNDS (LATEX)</b>				
237924 / 237824	LATEXPLAN TRADE FAST A / B	20KG / 4KG	5m <sup>2</sup> at 3mm	£14.83 / £21.33
237330 / 237730	LATEXPLAN TRADE A / B	25KG / 5KG	6m <sup>2</sup> at 3mm	£11.74 / £17.08
2371124 / 2371224	LATEXPLAN NO AMMONIA A / B	20KG / 4.4KG	5m <sup>2</sup> at 3mm	£15.67 / £22.56
<b>SMOOTHING COMPOUNDS (WATER-MIX)</b>				
1495720	ULTRAPLAN ECO 3210	20KG	5m <sup>2</sup> at 3mm	£29.18
4191725	ULTRAPLAN MAXI 3230	25KG	6m <sup>2</sup> at 3mm	£41.70
0124725	ULTRAPLAN RENOVATION SCREED 3240	25KG	6m <sup>2</sup> at 3mm	£29.21
1204344A	PLANIPREP FIX	4X4KG		£78.76
1203345A	PLANIPATCH XTRA	4X5KG		£43.67
<b>ADHESIVES FOR VINYL AND LVT</b>				
1943415	ULTRABOND ECO 380	15KG	up to 55m <sup>2</sup>	£84.22
0666215	ULTRABOND ECO 4 LVT	15KG	up to 60m <sup>2</sup>	£82.32
358015	ULTRABOND ECO FIX	15KG	"90m <sup>2</sup> (trl) 120m <sup>2</sup> (rllr)"	£129.56
0657115 / 0657105	ULTRABOND ECO VS90 PLUS	15KG / 5KG	up to 55m <sup>2</sup> / up to 18m <sup>2</sup>	£75.49 / £31.27
672115	ULTRABOND ECO V4 EVOLUTION	15KG	up to 75m <sup>2</sup>	£89.01
<b>ADHESIVES FOR CARPET</b>				
008315	ULTRABOND ECO TX3	15KG	up to 42m <sup>2</sup>	£61.55
3585915 / 3585905	ULTRABOND ECO TACK TX+	15KG / 5KG	up to 300m <sup>2</sup> / up to 100m <sup>2</sup>	£116.14 / £40.47
<b>HEAVY DUTY ADHESIVES</b>				
410311 / 410306 / 410302	ADESILEX G19 BEIGE	10KG / 5KG / 2KG	20m <sup>2</sup> / 10m <sup>2</sup> / 4m <sup>2</sup>	£98.89 / £53.59 / £27.44
2333307	ULTRABOND ECO MS 1	7KG	24m <sup>2</sup>	£78.27
<b>CONTACT ADHESIVE TAPES</b>				
637250 / 637450 / 637350	MAPECONTACT PLUS H25 / H85 / H40	12 / 3 / 7 X 50 MT	50lm	£210.44 / £144.91 / £172.66
<b>WOOD ADHESIVES</b>				
744915	ULTRABOND ECO S948 1K	15KG	15-18m <sup>2</sup>	£111.13
074315	ULTRABOND ECO S955 1K	15KG	15-18m <sup>2</sup>	£127.08
195135	ADESIVIL D3	20 X 0.5KG		£121.75
<b>ANCILLERIES</b>				
VARIOUS	MAPESIL AC SEALANT (55 COLOURS)	310 ML		£14.27
810016	MIXING BUCKET	30L		£15.12
790001	METAL SPREADER FOR PARQUET			£6.80

Prices are subject to change.



**Homogeneous Sheet Flooring**

Product	Gauge	Roll Length	Roll Width	£m <sup>2</sup> Full Rolls	£m <sup>2</sup> Cut Lengths	Promo Price
Polyflor Palettone PUR (Polish Free)	2mm	20m	2m	£20.33	£24.40	-
Polyflor Pearlazzo PUR (Polish Free)	2mm	20m	2m	£20.33	£24.40	-
Polyflor Prestige PUR (Polish Free)	2mm	20m	2m	£20.33	£24.40	-
Polyflor Classic Mystique PUR (Polish Free)	2mm	20m	2m	£18.99	£22.79	-
Polyflor 2000 PUR (Polish Free)	2mm	20m	2m	£15.79	£18.95	-
Polyflor 2000 PUR (Polish Free)	2.5mm	15m	2m	£19.71	£23.65	-
Polyflor XL PU	1.5mm	27.5m	2m	£10.99	£13.19	-
Polyflor XL PU	2mm	20m	2m	£14.39	£17.27	-
Polyflor Standard XL	1.5mm	27.5m	2m	£10.99	£13.19	-
Polyflor Standard XL	2mm	20m	2m	£14.39	£17.27	-

**Safety Flooring**

Product	Gauge	Roll Length	Roll Width	£m <sup>2</sup> Full Rolls	£m <sup>2</sup> Cut Lengths	Promo Price
Polysafe QuickLay PUR	2.2mm	20m	2m	£18.76	£22.51	-
Polysafe Quattro PUR	2mm	20m	2m	£23.06	£27.67	Rolls: £18.49m <sup>2</sup> Cuts: £22.15m <sup>2</sup>
Polysafe Astral PUR	2mm	20m	2m	£19.68	£23.62	-
Polysafe Stone FX PUR	2mm	20m	2m	£21.76	£26.11	£16.49m <sup>2</sup>
Polysafe Wood FX PUR	2mm	20m	2m	£21.76	£26.11	£16.49m <sup>2</sup>
Polysafe Mosaic PUR	2mm	20m	2m	£23.00	£27.60	-
Polysafe Vogue Ultra PUR	2mm	20m	2m	£19.68	£23.62	£12.95m <sup>2</sup>
Polysafe Standard PUR	2mm	20m	2m	£16.52	£19.82	£10.49m <sup>2</sup>
Polysafe Standard PUR	2.5mm	20m	2m	£21.69	£26.03	-
Polysafe Verona Original/Pure Colours PUR	2mm	20m	2m	£19.68	£23.62	£12.95m <sup>2</sup>
Polysafe Hydro	2mm	20m	2m	£22.69	£27.23	Rolls: £17.79m <sup>2</sup> Cuts: £20.99m <sup>2</sup>
Polysafe Hydro Evolve	2mm	20m	2m	£22.69	£27.23	-
Polysafe Apex 55	3mm	20m	2m	£26.09	£31.31	-
Polysafe Apex	2.5mm	20m	2m	£23.69	£28.43	-
Polysafe Ultima	2.5mm	20m	2m	£22.34	£26.81	-
Polysafe Wood FX Acoustix PUR	3.7mm	20m	2m	£23.76	£28.51	-

**Heterogeneous Sheet**

Product	Gauge	Roll Length	Roll Width	£m <sup>2</sup> Full Rolls	£m <sup>2</sup> Cut Lengths	Promo Price
Geotone QuickLay PUR	2.2mm	20m	2m	£18.76	£22.51	-
Silentflor PUR (Polish Free)	3.7mm	20m	2m	£17.92	£21.50	-
Bloc PUR (Polish Free)	2mm	20m	2m	£19.65	£23.58	-
Expona Flow PUR (Polish Free)	2mm	20m	2m	£17.49	£20.99	-
Forest FX PUR (Polish Free)	2mm	20m	2m	£17.14	£20.57	£11.99m <sup>2</sup>
Acoustix Forest FX PUR (Polish Free)	3.7mm	20m	2m	£18.64	£22.37	-

**Heterogeneous Luxury Vinyl Sheet**

Product	Gauge	Roll Length	Roll Width	£m <sup>2</sup> Full Rolls	£m <sup>2</sup> Cut Lengths	Promo Price
Architex PUR	3.5mm	20-25m	2/3/4m	£13.73	£16.48	-
Secura PUR	3mm	20-25m	2/3/4m	£13.08	£15.70	£10.95m <sup>2</sup>
Designatex PUR	3mm	20-25m	2/3/4m	£13.08	£15.70	£10.95m <sup>2</sup>

**Foam Backing Sheet**

Sheet	Suitable For	Standard Pack	Coverage	£Per m <sup>2</sup>
Acoustifoam	Polyflor & Polysafe Vinyl	2m x 20m	40m <sup>2</sup>	-

All trade and promotional prices run on full rolls until 31/08/2026. All prices are exclusive of V.A.T.



**Homogeneous Tile Flooring**

Tile	Gauge	Tile Size	Box Qty	m <sup>2</sup> Per Box	£Per m <sup>2</sup>
Palettone PUR (Polish Free)	2mm	608 x 608mm	14	5.17	£20.33
Classic Mystique PUR (Polish Free)	2mm	300 x 300mm	50	4.5	£18.99
Classic Mystique PUR (Polish Free)	2mm	608 x 608mm	14	5.17	£18.99
2000 PUR (Polish Free)	2mm	300 x 300mm	50	4.5	£15.79
2000 PUR (Polish Free)	2mm	608 x 608mm	14	5.17	£15.79
XL PU	2mm	300 x 300mm	50	4.5	£14.39
XL PU	2mm	608 x 608mm	14	5.17	£14.39
Standard XL	2mm	300 x 300mm	50	4.5	£14.39
Standard XL	2mm	608 x 608mm	14	5.17	£14.39

**Semi Flexible Tiles**

Product	Gauge	Tile Size	Box Qty	m <sup>2</sup> Per Box	£Per m <sup>2</sup>
Polyflex Plus PU	2mm	300 x 300mm	50	4.5	£11.72

**ESD Collection**

Sheet	Gauge	Roll Length	Roll Width	£m <sup>2</sup> Full Rolls	£m <sup>2</sup> Cut Lengths
Palettone SD	2mm	20m	2m	£24.98	£29.98
Finesse SD	2mm	20m	2m	£25.98	£31.18
Polyflor SD	2mm	20m	2m	£19.97	£23.96
Finesse EC	2mm	20m	2m	£29.95	£35.94
OHmega EC	2mm	20m	2m	£32.68	£39.22
Polyflor EC	2mm	20m	2m	£32.68	£39.22
Conductive ROF	2mm	20m	2m	£34.19	£41.03

Tile	Gauge	Tile Size	Box Qty	m <sup>2</sup> Per Box	£Per m <sup>2</sup>
Finesse SD	2mm	608 x 608mm	14	5.17	£25.98
Polyflor SD	2mm	608 x 608mm	14	5.17	£19.97
Polyflor EC	2mm	608 x 608mm	14	5.17	£32.68

**Rubber Flooring**

Tile	Gauge	Tile Size	Box Qty	m <sup>2</sup> Per Box	£Per m <sup>2</sup>
Noppe Stud Tile	3mm Group 1	500 x 500mm	20	5	£38.60
Noppe Stud Tile	3mm Group 2	500 x 500mm	20	5	£42.10

**Sports Flooring**

Sheet	Gauge	Roll Length	Roll Width	£m <sup>2</sup> Full Rolls	£m <sup>2</sup> Cut Lengths
*Sport 67 Sports floor with foam backing	6.7mm	18.5m	2m	£44.97	£53.96
Sport 67 Weld Rod		Sport flooring match		£28.41 Per Standard Pack (75 meters coil)	

**Welding Rod**

	Standard Pack	Ex-Stock Colours	£Per Pack
Welding Rod	100 Metres coil	Vinyl flooring match	£34.86

\* 1 cut length per order of full rolls.

All trade and promotional prices run on full rolls until 31/08/2026. All prices are exclusive of V.A.T.

**POLYFLOR**™  
COVERING THE WORLD

**POLYFLOR LUXURY VINYL TILES**

COLONIA™	DIMENSIONS (mm)			Box Qty	m <sup>2</sup> per box	£ Per m <sup>2</sup>
	Gauge	Width	Length			
Plank	2	For sizes & qty's of Colonia products, please contact Polyflor or see the Colonia brochure.			3.34/3.37	£19.30
Tile	2				3.34	£19.30
Borders	2	Available to special order			-	£19.50 each
Corners	2	Available to special order			-	£4.50 each
Feature Strip	2	5	1000	50	-	£27.00 pack
Design Strip**	2	10	914	50	-	£27.00 pack
	2	20	914	25	-	£27.00 pack
Grouting Strip	2	3	914	50	-	£27.00 pack
Marquetry Strip	2	3	914	50	-	£27.00 pack
Cross Grain Marquetry Strip	2	10	914	50	-	£32.00 pack
	2	25	914	25	-	£32.00 pack

Promo Price  
£12.49m<sup>2</sup>  
2mm Full Boxes

CAMARO™	DIMENSIONS (mm)			Box	m <sup>2</sup> per box	£ Per m <sup>2</sup>
	Gauge	Width	Length			
Plank	2	For sizes & qty's of Camaro products, please contact Polyflor or see the Camaro brochure.			3.34/3.37/3.62	£20.39
Tile	2				3.34	£20.39
Borders	2	Available to special order			-	£19.50 each
Corners	2	Available to special order			-	£4.50 each
Feature Strip	2	5	1000	50	-	£27.00 Pack
Design Strip**	2	10	914	50	-	£27.00 Pack
	2	20	914	25	-	£27.00 Pack
Grouting Strip	2	3	914	50	-	£27.00 Pack
Marquetry Strip	2	3	914	50	-	£27.00 Pack
Cross Grain Marquetry Strip	2	10	914	50	-	£32.00 pack
	2	25	914	25	-	£32.00 pack

Promo Prices  
£16.49m<sup>2</sup>  
70+ Full Boxes

£16.99m<sup>2</sup>  
35-69 Full Boxes

£17.49m<sup>2</sup>  
1-34 Full Boxes

CAMARO™ RIGID CORE	DIMENSIONS (mm)			Box Qty	m <sup>2</sup> per box	£ Per m <sup>2</sup>
	Gauge	Width	Length			
Plank	5.5	150*	910*	16	2.18	£28.73
	5.5	177*	1212*	10	2.15	£28.73
Herringbone	5.5	101*	609*	24	1.48	£28.73
Tile	5.5	304*	609*	12	2.22	£28.73

Promo Price  
£22.99m<sup>2</sup>  
Full Boxes

FUSIONline	DIMENSIONS (mm)			Box Qty	m <sup>2</sup> per box	£ Per m <sup>2</sup>
	Gauge	Width	Length			
Plank	2.5	76	457	96	3.34	£21.50
	2.5	101	609	54	3.34	£21.50
	2.5	184	1219	15	3.37	£21.50
Tile	2.5	457	914	8	3.34	£21.50

CONCEPTline	DIMENSIONS (mm)			Box Qty	m <sup>2</sup> per box	£ Per m <sup>2</sup>
	Gauge	Width	Length			
Plank	2	76	228	192	3.34	£18.99
	2	184	1219	15	3.37	£18.99
Grouting Strip	2	3	914	50	-	£27.00 Pack
Marquetry Strip	2	3	914	50	-	£27.00 Pack
Feature Strip	2	5	1000	50	-	£27.00 Pack
Cross Grain Marquetry Strip	2	10	914	50	-	£32.00 pack
	2	25	914	25	-	£32.00 pack

All decorative strips can be used with the full Conceptline collection and all bevelled Fusionline shades

EnCORE RIGID LOC	DIMENSIONS (mm)			Box Qty	m <sup>2</sup> per box	£ Per m <sup>2</sup>
	Gauge	Width	Length			
Plank	6.5	177*	1212*	10	2.15	£36.25
	6.5	196*	1212*	9	2.14	£36.25

All trade and promotional prices run on full boxes until 31/08/2026. All prices are exclusive of V.A.T.

\*Sizes shown excludes the tongue and groove \*\*Design strips available to order

**POLYFLOR**™  
COVERING THE WORLD

**POLYFLOR LUXURY VINYL TILES**

EXPONA COMMERCIAL	DIMENSIONS (mm)			Box Qty	£ Per m <sup>2</sup>
	Gauge	Width	Length		
Plank	2.5	For sizes & qty's of Expona products, please contact Polyflor or see the Expona brochure.			£23.59
Tile	2.5				£23.59
Borders	2.5	Available to special order			
Corners	2.5	Available to special order			
Grouting Strip	2.5	5	914	50	£27.00 pack
Marquetry Strip	2.5	5	914	50	£27.00 pack
Feature Strip	2.5	5	1000	50	£27.00 pack

**Trade Prices**  
**£19.49m<sup>2</sup>**  
**150m<sup>2</sup> +**

**£20.49m<sup>2</sup>**  
**100-150m<sup>2</sup>**

Affinity2 <sup>SS™</sup>	DIMENSIONS (mm)			Box Qty	m <sup>2</sup> per box	£ Per m <sup>2</sup>
	Gauge	Width	Length			
Plank	2	184	1219	15	3.37	£21.63
Feature Strip	2	5	1000	50	-	£27.00 pack
Marquetry Strip	2	3	914	50	-	£27.00 pack
Cross Grain Marquetry Strip	2	10/25	914	50/25	-	£32.00 pack

EXPONA DESIGN	DIMENSIONS (mm)			Box Qty	£ Per m <sup>2</sup>
	Gauge	Width	Length		
Plank	3	For sizes & qty's of Expona products, please contact Polyflor or see the Expona brochure.			£25.95
Tile	3				£25.95
Borders	3	Available to special order			
Corners	3	Available to special order			
Grouting Strip	3	5	914	50	£27.00 pack
Marquetry Strip	3	5	914	50	£27.00 pack
Feature Strip	3	5	1000	50	£27.00 pack

EXPONA CONTROL	DIMENSIONS (mm)			Box Qty	£ Per m <sup>2</sup>
	Gauge	Width	Length		
Plank	2.5	For sizes & qty's of Expona products, please contact Polyflor or see the Expona brochure.			£27.25
Tile	2.5				£27.25
Grouting Strip	2.5	5	914	50	£27.00 pack
Marquetry Strip	2.5	5	914	50	£27.00 pack
Feature Strip	2.5	5	1000	50	£27.00 pack

EXPONA SIMPLAY	DIMENSIONS (mm)			Box Qty	m <sup>2</sup> per box	£ Per m <sup>2</sup>
	Gauge	Width	Length			
Plank	5	178	1219	10	2.17	£31.85
	5	185	1505	8	2.23	£31.85
Tile	5	178	1219	10	2.17	£31.85
	5	304	609	10	1.86	£31.85
	5	600	600	6	2.16	£31.85
	5	914	914	4	3.34	£31.85
Double-Sided Tape	Contact Polyflor for further details					

EXPONA SIMPLAY 19dB	DIMENSIONS (mm)			Box Qty	m <sup>2</sup> per box	£ Per m <sup>2</sup>
	Gauge	Width	Length			
Plank	5	177	1219	10	2.17	£31.85
Tile	5	600	600	6	2.16	£31.85

All trade and promotional prices run on full boxes until 31/08/2026. All prices are exclusive of V.A.T.



## STAIRNOSINGS

### ALUMINIUM STAIRNOSINGS

Add 5% for drilling.

No floorcovering / Surface mounted: Gauge 0.0mm. Price per m cut including infill

Straight (F)	£/m	Rake Back (R)	£/m	Bull Nose (B)	£/m
SF125R	£20.25	SR125R	£20.25	SB153R	£25.59

Resilient floorcovering / Vinyl: Gauge 2.0 - 3.5mm. Price per m cut including infill

Straight (F)	£/m	Rake Back (R)	£/m	Bull Nose (B)	£/m
SF1	£17.63	SR1	£17.63	SB1	£15.68
SF153	£19.63	SR153	£19.63	SB136	£22.39

Carpet / Carpet tile: Gauge 4.0mm - 9.0mm. Price per m cut including infill

Straight (F)	£/m	Rake Back (R)	£/m	Bull Nose (B)	£/m
HF1	£20.95	HR1	£20.95	HB1	£26.32
HF153	£23.07	HR153	£23.07	HB157	£29.18

### Z RANGE STAIRNOSINGS

No floorcovering / Surface mounted: Gauge 0.0mm. Price per m cut including infill

Straight (F)	£/m	Rake Back (R)	£/m	Bull Nose (B)	£/m
ZF125R	£15.41	ZR125R	£15.41	ZB136R	£15.41
ZF153R	£17.59	ZR153R	£17.59		

Resilient floorcovering / Vinyl: Gauge 2.0 - 3.5mm. Price per m cut including infill

Straight (F)	£/m	Rake Back (R)	£/m	Bull Nose (B)	£/m
ZF1	£14.62	ZR1	£14.62	ZB1	£14.62
ZF2	£19.76	ZR2	£19.76		

Carpet / Carpet tile: Gauge 4.0mm - 9.0mm. Price per m cut including infill

Straight (F)	£/m	Rake Back (R)	£/m	Bull Nose (B)	£/m
ZHF1	£16.53	ZHR1	£16.53	ZHB1	£16.53

### TRIMS EDGINGS ANGLES & FABRICATIONS

Code	£/ea
UTA 90° or 83° (incl. Tabs)	£11.57

### PVC TRANSITION PROFILES – FLEXIBLE BEVEL STRIPS

Code	£/m	Packing	Colour
QT200 2.0mm Dim Strip	£1.13	5 x 25 m	Black
QT250 2.5mm Dim Strip	£1.24	5 x 25 m	Black
QT320 3.2mm Dim Strip	£1.34	5 x 25 m	Black
QTR10 Threshold	£25.28	5 x 2 m	Black

### PVC TRANSITION PROFILES – FLEXIBLE RAMP TRIMS

Code	£/m	Packing	Colour
QT450 (rib) / QFT450 (flat)	£3.92	50 x 2 m	Black
QT600 (rib) / QFT600 (flat)	£4.31	40 x 2 m	Black

### PVC ACCESSORIES

Price per metre for full boxes. Split boxes add 25%

Code	£/m	Packing	Colour
CCFM1 Internal Mitre	£2.81	50	Black
CCFM2 External Mitre	£2.81	50	Black
UCS2 Capping	£2.29	5 x 20 m coils	White / Black
Q100 SO Sit-on Skirting	£2.17	30 x 2 m or 1 x 32 m	Black
QCT1R (rigid)	£5.95	50 x 2 m	White
QCF35 Cove Former	£1.81	40 x 2 m	Black
QCC1 Capping	£3.18	40 x 2 m	Black

### Z RANGE PVC ACCESSORIES

Skirtings / Cove Formers / Cappings. Price per metre for full boxes. Black only

Code	£/m	Packing	Colour
QZ100 SO Sit-on Skirting	£1.92	30 x 2 m or 1 x 32 m	Black
QZ100 SO 2 Set-in Skirting	£3.05	14 x 2 m or 1 x 16 m	Black
ZECF4 Cove former	£2.36	40 x 2 m	Black
ZUCS1 Capping	£2.41	40 x 2 m	Black

# Rewmar

# flexyfix

[www.rewmar.co.uk](http://www.rewmar.co.uk)

## PRICE LIST 2026

		Recommended Trade Price
FLE-290	Flexy Fix 290ml Cartridge ^	7.82
FLE-290-BLK	Flexy Fix 290ml Cartridge - Black ^	7.82
REW 15KG	Rewmar MS Polymer Adhesive 15kg Tub	92.37
REW-MS4600	Rewmar MS4600 Adhesive (12 x 600ml)	114.79
REW-MS650	Rewmar MS650 Adhesive (12 x 600ml)	90.36
APA-15KGS	All Floors Adhesive 15kgs	59.00
PLA-13KG	Flexyfix Platinum Hybrid Adhesive 13kg Tub	79.00
PLA-5KG	Flexyfix Platinum Hybrid Adhesive 5kg Tub	36.00
LVT-13KG	Flexyfix LVT Adhesive 13kgs	68.00
LVT-5KG	Flexyfix LVT Adhesive 5kgs	31.00
VIN-APP5L	Multi Purpose Primer 5ltr	23.00
FSS-CLEAR	Flexy Fix Silicone 290ml - Clear ^	5.46
FSS-WHITE	Flexy Fix Silicone 290ml - White ^	5.46
REW-PV5	Rewmar PVA Wood Glue (D3) ^	5.63
REW-RPDPM	Rewmar Rapid DPM - 6kg	87.77
LAW-290	Lawnfix 290ml Cartridge ^	5.53
REW-JT300	Joint Tape (150g/m <sup>2</sup> Flat Bond) - 300mm x 100m	127.41
REW-300	Rewmar 300 Slatted Underlay (16.5m <sup>2</sup> )	66.90
FLE-GUN	Flexyfix Pro Skeleton Gun 310ml (Black)	14.87
FLE-GUN-R	Flexyfix Pro-XL Skeleton Gun 400ml (Red)	16.51
REW-6AG	Rewmar 600ml Applicator Gun	34.21
REW-3MM	Rewmar 3mm V Notch Trowel (B3 - 18cm) ^	6.62
REW-6MM	Rewmar 6mm V Notch Trowel (B11 - 18cm) ^	6.62
REW-HTW	Rewmar Hand & Tool Wipes (100 wipes) 250x200mm	7.00
FFS-CLEAR	Flexy Fix Sealant 290ml - Clear ^	7.86
FFS-GREY	Flexy Fix Sealant 290ml - Grey ^	7.86
FFS-WHITE	Flexy Fix Sealant 290ml - White ^	7.86

^ Sold as full boxes of 12

























Product	Gauge	Roll length/ tile size	Trade/ List price	Public/ Promo price
<b>SAFETY FLOORCOVERINGS</b>				
	<b>Gauge</b>	<b>Roll length/ tile size</b>		
SAFETRED WOOD	2.0mm	Sheet 20lm x 2m	19.81	16.95
SAFETRED SERENITY	2.0mm	Sheet 20lm x 2m	23.42	16.42
SAFETRED UNIVERSAL R12	2.0mm	Sheet 20lm x 2m	23.19	19.49
SAFETRED UNIVERSAL R11	2.0mm	Sheet 20lm x 2m	21.78	18.30
SAFETRED SPECTRUM	2.0mm	Sheet 20lm x 2m	17.06	11.97
SAFETRED UNIVERSAL	2.0mm	Sheet 20lm x 2m	16.42	11.44
PRIMO SAFE.T (Suitable for barefoot & shod)	2.0mm	Sheet 25lm x 2m	20.98	16.42
GRANIT MULTISAFE (Suitable for barefoot & shod)	2.0mm	Sheet 25lm x 2m	21.13	17.76
GRANIT SAFE.T (Suitable for barefoot & shod)	2.0mm	Sheet 25lm x 2m	21.13	17.76
<b>HOMOGENEOUS iQ FLOORCOVERINGS</b>				
	<b>Gauge</b>	<b>Roll length</b>		
iQ OPTIMA	2.0mm	Sheet 25lm x 2m	21.78	18.30
iQ EMINENT	2.0mm	Sheet 23lm x 2m	21.78	18.30
iQ GRANIT	2.0mm	Sheet 25lm x 2m	21.78	18.30
<b>HOMOGENEOUS PREMIUM FLOORCOVERINGS</b>				
	<b>Gauge</b>	<b>Roll length/ tile size</b>		
ECLIPSE PREMIUM	2.0mm	Sheet 23lm x 2m	17.09	14.37
PRIMO PREMIUM	2.0mm	Sheet 23lm x 2m	17.09	14.37
<b>HOMOGENEOUS PLUS FLOORCOVERINGS</b>				
	<b>Gauge</b>	<b>Roll length/ tile size</b>		
VYLON PLUS	2.0mm	Sheet 20lm x 2m	10.23	8.60
VYLON PLUS TILES	2.0mm	Tile 30 x 30cm	13.61	11.43
STANDARD PLUS	2.0mm	Sheet 23lm x 2m	13.22	11.11
CONTRACT PLUS	2.0mm	Sheet 23lm x 2m	17.10	14.37
<b>HOMOGENEOUS ACOUSTIC FLOORCOVERINGS</b>				
	<b>Gauge</b>	<b>Roll length</b>		
<b>HETEROGENEOUS ACOUSTIC FLOORCOVERINGS</b>				
	<b>Gauge</b>	<b>Roll length/ tile size</b>		
TAPIFLEX ESSENTIAL 50 20dB	3.3mm	Sheet 23lm x 2m	17.74	14.91
TAPIFLEX ESSENTIAL 50 TILE 19dB	3.3mm	Tile 50 x 50cm	21.13	17.76
CONTRACT WOOD ACOUSTIC 19dB	3.0mm	Sheet 23lm x 2m	19.06	16.01
TAPIFLEX EXCELLENCE 80 19dB	3.35mm	Sheet 23lm x 2m	21.13	17.76
TAPIFLEX EXCELLENCE 80 TILES 19dB	3.45mm	Tile 50 x 50cm	23.85	20.03
TAPIFLEX PLATINIUM	3.1mm	Sheet 23lm x 2m	34.09	28.65
<b>HETEROGENEOUS COMPACT FLOORCOVERINGS</b>				
	<b>Gauge</b>	<b>Roll length</b>		
ACCZENT PLATINIUM	2.0mm	Sheet 23lm x 2m	30.72	25.82
ACCZENT EXCELLENCE 80	2.0mm	Sheet 23lm x 2m	19.81	16.65
CONTRACT WOOD	2.0mm	Sheet 23lm x 2m	17.16	14.19
<b>WELDING RODS</b>				
		<b>Length</b>		
PLAIN WELDING ROD		PVC Coil 50m	28.74	24.07
MULTICOLOURED 'CAMOUFLAGE' WELDING ROD*		Coil 45m	22.76	19.06
PLAIN WELDING ROD LINOLEUM xf2		Coil 50m	71.42	59.82
MULTICOLOURED WELDING ROD LINOLEUM xf2		Coil 50m	85.86	71.91

		Ultra Floor Price List - Valid from 1st January 2026					
Product Image	Product Code	Description	Pack Size	Pallet Size	Contractor A	Contractor B	Contractor C
	Level it Two Complete Unit	<ul style="list-style-type: none"> <li>• Bag &amp; Bottle</li> <li>• General Purpose</li> <li>• Depths of 2-12mm</li> <li>• Excellent flow, easy application suitable for common substrates including concrete, sand and cement and UFH.</li> <li>• Cover time from 8 hours.</li> <li>• Moisture tolerant</li> </ul>	20kg + 4.0Ltr	48 per pallet	£13.79	£14.25	£15.61
	Level it 2 20kgs	Level it Two filled bag only	20kg	48 per pallet	£8.69	£8.98	£9.84
	Level it Two Bot Dist	Level it Two filled bottle only	4.0Ltr	96 per pallet	£5.10	£5.27	£5.77
	Level it Multi-Pro Complete Unit	<ul style="list-style-type: none"> <li>• Bag &amp; Bottle</li> <li>• Minimal preparation required</li> <li>• 20% Recycled content.</li> <li>• Extended 45 minute working time.</li> <li>• Depths of 2-15mm.</li> <li>• Suitable for old adhesive residues and bitumen, flooring grade plywood, DPMS, most styles of existing tile.</li> <li>• No need to prime on most substrates.</li> <li>• Cover time from 4 hours.</li> <li>• Moisture tolerant.</li> </ul>	20kg + 5Ltr	48 per pallet	£19.96	£21.98	£23.34
	Level it Multi-Pro	Level it Multi Pro filled bag only	20kg	48 per pallet	£12.57	£13.85	£14.71
	Level it Multi-Pro Bot Dist	Level it Multi Pro filled bottle only	5Ltr	96 per pallet	£7.39	£8.13	£8.63
	Level it Super 30 Complete Unit	<ul style="list-style-type: none"> <li>• Bag &amp; Bottle</li> <li>• Rapid drying 30 min</li> <li>• Depths of 2-12mm</li> <li>• Rapid drying, high performance suitable for most common substrates such as concrete, sand and cement.</li> <li>• Cover time from 90 minutes</li> </ul>	20kg + 4.0Ltr	48 per pallet	£18.45	£19.75	£21.57
	Level it Super 30	Level it Super 30 filled bag only	20kg	48 per pallet	£11.62	£12.44	£13.59
	Level it Sup30 Bot Dist	Level it Super 30 filled bottle only	4.0Ltr	96 per pallet	£6.83	£7.31	£7.98
	Level it Pro 30 Complete Unit	<ul style="list-style-type: none"> <li>• Bag &amp; Bottle</li> <li>• Minimal prep needed, Ammonia Free &amp; Rapid Drying 30 min</li> <li>• Depths of 2-15mm</li> <li>• Suitable for old adhesive residues, bitumen, plywood, DPMS, existing tile. No need to prime</li> <li>• Cover time 90 minutes.</li> </ul>	20kg + 4.6L	48 per pallet	£19.89	£21.42	£23.23
	Level it Pro 30	Level it Pro 30 Filled bag only	20kg	48 per pallet	£12.53	£13.49	£14.63
	Level it Pro 30 Bot Dist	Level it Pro 30 filled bottle only	4.6Ltr	96 per pallet	£7.36	£7.93	£8.60
	Level it Super Flex 30 Complete Unit	<ul style="list-style-type: none"> <li>• Bag &amp; Bottle</li> <li>• Rapid drying 30 min &amp; super-flexible</li> <li>• Depths of 2-10mm</li> <li>• Rapid drying, flexible fibre reinforced for floors subject to slight vibration or thermal movement such as rigid steel where rapid turnaround is needed</li> <li>• Cover time from 1 hour</li> </ul>	20kg + 5Ltr	48 per pallet	£26.13	£27.58	£29.20
	Level it Flex	Level it Super Flex 30 filled bag only	20kg	48 per pallet	£16.46	£17.38	£18.40
	Level it Flex Bot Dist	Level it Super Flex 30 filled bottle only	5.0Ltr	96 per pallet	£9.67	£10.20	£10.80
	Level it Hydra Bond	<ul style="list-style-type: none"> <li>• Water Based</li> <li>• 20% Recycled content</li> <li>• Minimal prep needed, no need to prime on some surfaces.</li> <li>• Depths of 2-30mm</li> <li>• Suitable for old adhesive residues and bitumen, flooring grade plywood, DPMS, most styles of existing tile.</li> <li>• Cover time from 4 hours.</li> <li>• Moisture tolerant</li> </ul>	20kg	48 per pallet	£18.69	£20.25	£22.43
	Level it Renovate	<ul style="list-style-type: none"> <li>• Water Based</li> <li>• Fibre Reinforced</li> <li>• Depths of 3-40mm</li> <li>• Suitable for screed, stone, ceramic, timber and some UFH.</li> <li>• Cover time from 4 hours.</li> <li>• Internal &amp; External use</li> <li>• Moisture Tolerant</li> </ul>	20kg	48 per pallet	£14.37	£15.24	£16.26

		Ultra Floor Price List - Valid from 1st January 2026					
Product Image	Product Code	Description	Pack Size	Pallet Size	Contractor A	Contractor B	Contractor C
	Level it Smooth	<ul style="list-style-type: none"> <li>Water Based</li> <li>Fine flow for LVT</li> <li>Depths of 2-30mm</li> <li>Ultra fine, high strength, suitable for common substrates including concrete and sand and cement.</li> <li>Cover time from 12 hours.</li> </ul>	20kg	48 per pallet	£15.71	£17.06	£18.37
	Level it Base	<ul style="list-style-type: none"> <li>Water Based</li> <li>Deep fill applications.</li> <li>Depths of 5-50mm</li> <li>Suitable for building up deep areas in one application, including industrial areas where a final wear surface is to be applied.</li> <li>Cover time from 24 hours.</li> </ul>	25kg	48 per pallet	£13.89	£14.86	£16.08
	Level it Top	<ul style="list-style-type: none"> <li>Water Based</li> <li>Heavy duty surface finish</li> <li>Depths of 5-15mm</li> <li>High strength, suitable as a surface finish in industrial, applications and where a resin coating is to be applied.</li> <li>Cover time from 25 hours</li> </ul>	25kg	48 per pallet	£19.21	£21.07	£22.64
	Ultracem Screed it	<ul style="list-style-type: none"> <li>Fibre modified hydraulic cement binder for bonded, unbonded or floating screeds.</li> <li>Rapid drying, Ready to receive floor coverings from 24 hours.</li> <li>Foot traffic 12 hours.</li> <li>Approved for use with 0/4mm aggregate.</li> <li>Internal and external applications.</li> </ul>	20kg	48 per pallet	£12.76	£13.36	£14.39
	Prime it MSP	<ul style="list-style-type: none"> <li>For both porous and non porous substrates</li> <li>Pigmented Pink</li> <li>Coverage when diluted 200m<sup>2</sup></li> </ul>	5ltr	96 per pallet	£32.92	£36.25	£38.89
	Prime it GRIT	<ul style="list-style-type: none"> <li>For non porous substrates</li> <li>Textured surface for enhanced adhesion</li> <li>Pigmented Green</li> <li>40-50m<sup>2</sup> coverage</li> <li>Rapid Drying</li> </ul>	5ltr	96 per pallet	£33.35	£36.87	£39.66
	Feather it	<ul style="list-style-type: none"> <li>Resealable Tub included</li> <li>Ultra-fine for smooth finish</li> <li>Depths of 0-3mm</li> <li>Cover time from 15 minutes</li> </ul>	5kg (tub)	100 per pallet	£15.31	£16.60	£17.86
	Patch it	<ul style="list-style-type: none"> <li>Resealable Tub included</li> <li>Slump free, rapid setting for internal use on floors and walls.</li> <li>Depths of 1-20mm</li> <li>Cover time from 90 minutes</li> </ul>	10kg (tub)	56 per pallet	£14.29	£15.49	£16.68
	DPM it 5kg	<ul style="list-style-type: none"> <li>2 Component Epoxy DPM, 1 coat</li> <li>Rapid curing, guarantees early laying of all floorcoverings.</li> <li>Up to 98% RH Protection</li> <li>Set time from 5 hours.</li> </ul>	5kg (tub)	80 per pallet	£66.14	£70.50	£74.94
	DPM it 10kg	<ul style="list-style-type: none"> <li>2 Component Epoxy DPM, 1 coat</li> <li>Rapid curing, guarantees early laying of all floorcoverings.</li> <li>Up to 98% RH Protection</li> <li>Set time from 5 hours.</li> </ul>	10kg (tub)	48 per pallet	£130.23	£138.90	£146.73
	FLOOR IT DPM	<ul style="list-style-type: none"> <li>2 Component Epoxy DPM, 1 coat</li> <li>Up to 98% RH Protection</li> <li>Set time from 6 hours.</li> </ul>	25kg unit	22 per pallet	£200.00	£225.00	£250.00

		<b>Ultra Floor Price List - Valid from 1st January 2026</b>					
Product Image	Product Code	Description	Pack Size	Pallet Size	Contractor A	Contractor B	Contractor C
	Suppress IT	<ul style="list-style-type: none"> <li>• 1 Component residual moisture vapour suppressant</li> <li>• Up to 95% RH Protection</li> <li>• Cover time from 90 minutes.</li> <li>• Removes the need to prime</li> </ul>	5L	96 units per pallet	<b>£46.29</b>	<b>£51.58</b>	<b>£54.70</b>
	Suppress IT IBC	<ul style="list-style-type: none"> <li>• 1 Component residual moisture vapour suppressant</li> <li>• Up to 95% RH Protection</li> <li>• Cover time from 90 minutes.</li> <li>• Removes the need to prime</li> <li>• Covers approx. 3,300m2</li> </ul>	1000L	1 Unit	<b>£5,188.00</b>	<b>£5,802.00</b>	<b>£6,485.00</b>
	Mixing Bucket	Universal Branded 28L Mixing Bucket	28L	Singles	<b>£6.54</b>	<b>£7.18</b>	<b>£8.90</b>
	Grip & Grab it	<ul style="list-style-type: none"> <li>• All purpose flexible MS-polymer adhesive</li> <li>• Rapid set 17 minutes</li> <li>• Can be used in damp conditions</li> </ul>	290ml	12 per box	<b>£6.79</b>	<b>£7.54</b>	<b>£8.46</b>
	STICK IT 500	Multi Purpose Adhesive for PVC & Cushion Vinyl, Hessian, PVC & Synthetic Backed Carpet, Linoleum, Needlefelt, Corkment floor coverings. <ul style="list-style-type: none"> <li>• High initial adhesion strength and final bond strength.</li> <li>• Favourable spreading capacity.</li> <li>• Roller-castor-chair resistant.</li> </ul>	15kg	44 units	<b>£39.27</b>	<b>£47.13</b>	<b>£55.11</b>
	STICK IT 542	Very Low Emission Tackifier Adhesive For The Installation of Carpet Tiles, Loose Lay PVC Floor Coverings. <ul style="list-style-type: none"> <li>• Easy removal.</li> <li>• Favourable spreading capacity.</li> <li>• Ergonomic processing.</li> <li>• Permanent adhesion.</li> </ul>	10kg	60 units	<b>£51.76</b>	<b>£60.38</b>	<b>£69.01</b>
	STICK IT 543	Pressure Sensitive & High Temperature Adhesive For The Installation of PVC Sheet, Strips & Tiles. <ul style="list-style-type: none"> <li>• Pressure sensitive.</li> <li>• High temperature resistant.</li> <li>• Solvent free.</li> <li>• Favourable spreading capacity.</li> <li>• No grin through of adhesive trowel marks.</li> <li>• High final bond strength.</li> </ul>	10kg	44 units	<b>£57.93</b>	<b>£67.58</b>	<b>£77.23</b>
	STICK IT 611	Very Low Emission Linoleum Adhesive With Initial High Grab. <ul style="list-style-type: none"> <li>• High quality, strong, resin-free, Linoleum dispersion-based adhesive.</li> <li>• High initial bonding strength and enhanced open time.</li> <li>• Favourable spreading capacity giving up to 25% lower adhesive consumption.</li> </ul>	11kg	44 units	<b>£49.60</b>	<b>£58.38</b>	<b>£66.13</b>
	STICK IT 640	Adhesive for PVC Floor Coverings in Sheet & Tiles, PVC Backed Carpet, Rubber Floor Coverings in Sheet & Tiles & Polyolefin Floor Coverings. <ul style="list-style-type: none"> <li>• Enhanced open time up to 120 minutes.</li> <li>• High initial bonding strength and enhanced open time.</li> <li>• Short waiting time.</li> <li>• Long final adhesion strength.</li> </ul>	12kg	44 units	<b>£46.35</b>	<b>£54.07</b>	<b>£61.80</b>

Product	Description / Use		Pack Size	Pallet Quantity	Approximate Coverage	List Price per pack size/£
<b>SUBSTRATE PRIMERS</b>						
UZIN PE 280	Rapid drying primer for smooth dense surfaces and DPMs		12 kg	50	Up to 170 m <sup>2</sup>	230.06
			5 kg	80	Up to 71 m <sup>2</sup>	103.71
UZIN PE 360 PLUS	Dispersion primer for absorbent surfaces		10 kg Canister	60	Up to 125 m <sup>2</sup>	100.08
			5 kg Cube	128	Up to 62 m <sup>2</sup>	53.15
UZIN PE 630	2-Component filler & primer for use with UZIN NC 175 & UZIN NC 196		16 kg	24	30 to 60 m <sup>2</sup>	115.00
<b>DAMP CONTROL SYSTEMS</b>						
UZIN PE 404	Rapid drying residual moisture suppressant		10 kg	60	Up to 40 m <sup>2</sup> at 2 coats	219.21
UZIN PE 481	Cost-effective one coat DPM		10 kg	36	Up to 28 m <sup>2</sup> at 1 coat	220.43
<b>REPAIR MORTARS</b>						
UZIN NC 182 NEW	Low slump rapid repair		12.5 kg	60	Approx. 8 m <sup>2</sup> at 1 mm	30.69
UZIN NC 888 S	Very rapid drying fine repair mortar		4.5 kg	160	Approx. 4.1 m <sup>2</sup> at 1 mm	28.20
<b>SMOOTHING COMPOUNDS</b>						
UZIN L2 Contract Powder UZIN L2 Contract Liquid	Cost effective 2 part smoothing compound		20 kg	50	Approx. 5 m <sup>2</sup> at 3 mm	13.69
			4.8 kg	100		10.16
UZIN NC 151	Heavy duty smoothing compound up to 20 mm		20 kg	54	Approx. 5 m <sup>2</sup> at 2 – 3 mm	27.58
UZIN NC 163	Smoothing compound which can be used without priming		20 kg	54	Approx. 5 m <sup>2</sup> at 3 mm	38.62
UZIN NC 196	Fibre reinforced smoothing compound up to 40 mm		20 kg	54	Approx. 5 m <sup>2</sup> at 3 mm	22.65
<b>UNDERLAY</b>						
UZIN RR 620	LVT underlay, 7.5 x 1 m		1 roll	40	7.5 m <sup>2</sup>	96.64
<b>ADHESIVES</b>						
UZIN KE 49 HT	High temperature or pressure sensitive adhesive		14 kg	33	Up to 70 m <sup>2</sup>	142.59
			6 kg	75	Up to 30 m <sup>2</sup>	64.56
UZIN KE 2000 S	Pressure sensitive adhesive for vinyl, LVTs and rubber		14 kg	33	Up to 77 m <sup>2</sup>	123.65
			6 kg	72	Up to 33 m <sup>2</sup>	55.71
			2 kg	150	Up to 11 m <sup>2</sup>	28.90
UZIN KE 2428 NEW	Rapid vinyl, lino and carpet adhesive		14 kg	33	Up to 60 m <sup>2</sup>	80.59
UZIN KE 66 HT	High temperature adhesive for rubber, LVTs and vinyl		14 kg	33	Up to 82 m <sup>2</sup>	129.09
			6 kg	72	Up to 35 m <sup>2</sup>	58.09
UZIN KE 68	1-Component adhesive for heavy duty floor-coverings		8.5 kg	65	Up to 34 m <sup>2</sup>	121.06
UZIN U 2100	Carpet tile tackifier		10 kg	60	Up to 200 m <sup>2</sup> (roller)	147.46
UZIN UZ 54	Solvent-free carpet adhesive		14 kg	33	Up to 56 m <sup>2</sup>	71.75
UZIN U-Tack 25 / 25 mm x 50 m	Multi-purpose skirting, capping & coving tape		1 roll (20 rolls per box)**	864**		17.44
UZIN U-Tack 40 / 40 mm x 50 m	Multi-purpose skirting, capping & coving tape		1 roll (16 rolls per box)**	576**		22.38
UZIN U-Tack 50 / 50 mm x 50 m	Multi-purpose skirting, capping & coving tape		1 roll (12 rolls per box)**	432**		28.25
UZIN U-Tack 85 / 85 mm x 50 m	Multi-purpose skirting, capping & coving tape		1 roll (6 rolls per box)	216**		47.35
UZIN Remur 25 / 45 mm x 50 m	Skirting, capping & coving tape		8 rolls/pack	240 rolls		247.45
UZIN Remur 95 / 95 mm x 50 m*	Skirting, capping & coving tape		2 rolls/pack*	120 rolls*		213.64
UZIN Remur 95 / 95 mm x 50 m*	Skirting, capping & coving tape		3 rolls/pack*	216 rolls*		320.46

\*The number of rolls per box will change from 2 to 3 and pallet quantities will change in June 2026.

\*\*The number of rolls per box and pallet quantities will change during 2026, once the existing stock has been sold.



# CONTACT US OUR SALES OFFICES

Leeds Mercado  
& Leeds Gildersome

**03330 494 320**

---

Bridgend  
& Thatcham

**03330 494 330**

Newcastle & Stockton on  
Tees (Solmere)

**03330 494 237**

---

Coleshill, Kidderminster  
& Nottingham

**03330 494 378**