

Job No: F 23 231
 Name: MCINTOSH
 Address: 8 ROSAVINE ROAD
 SW6 7BL
 Tel:
 Sheet: 1 OF 5

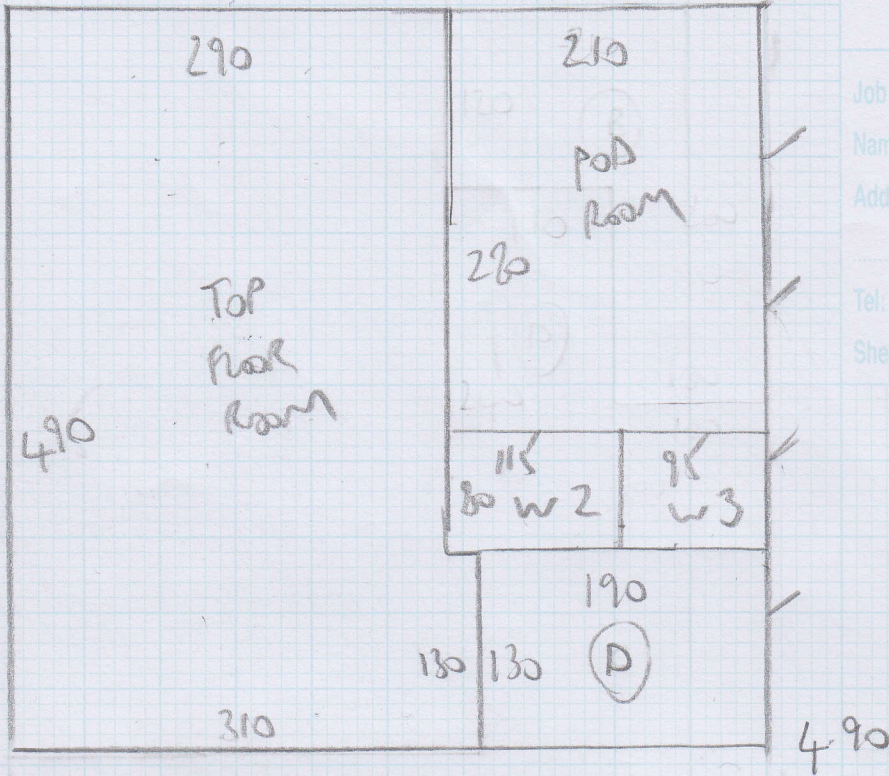

MICHIGAN
620/28

- 4.90 PLAN
- 6.60 PLAN
- 3.60 BED
- 7.90 PLAN

23.00 M

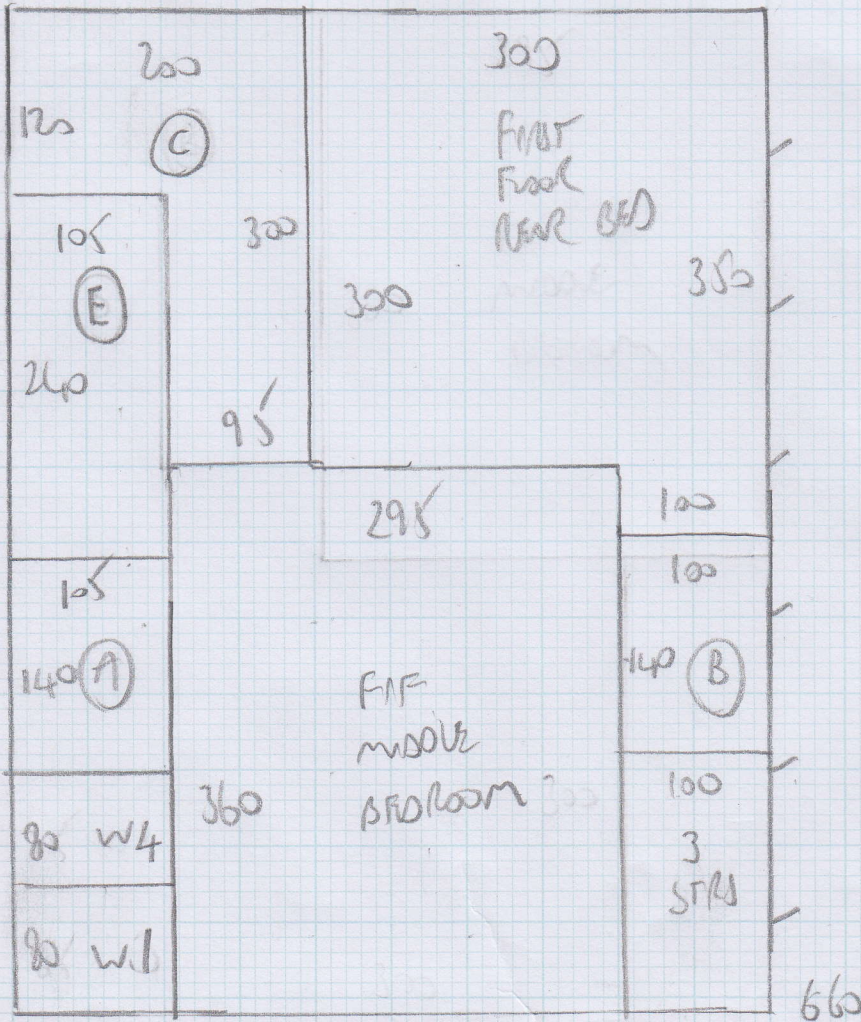

CUT 3-60 x 5M
LAST

Job No: F 23231
Name: MCINTOSH
Address: 8 ROSAVILLE ROAD
SW6 7BL
Tel:
Sheet: 2 OF 5

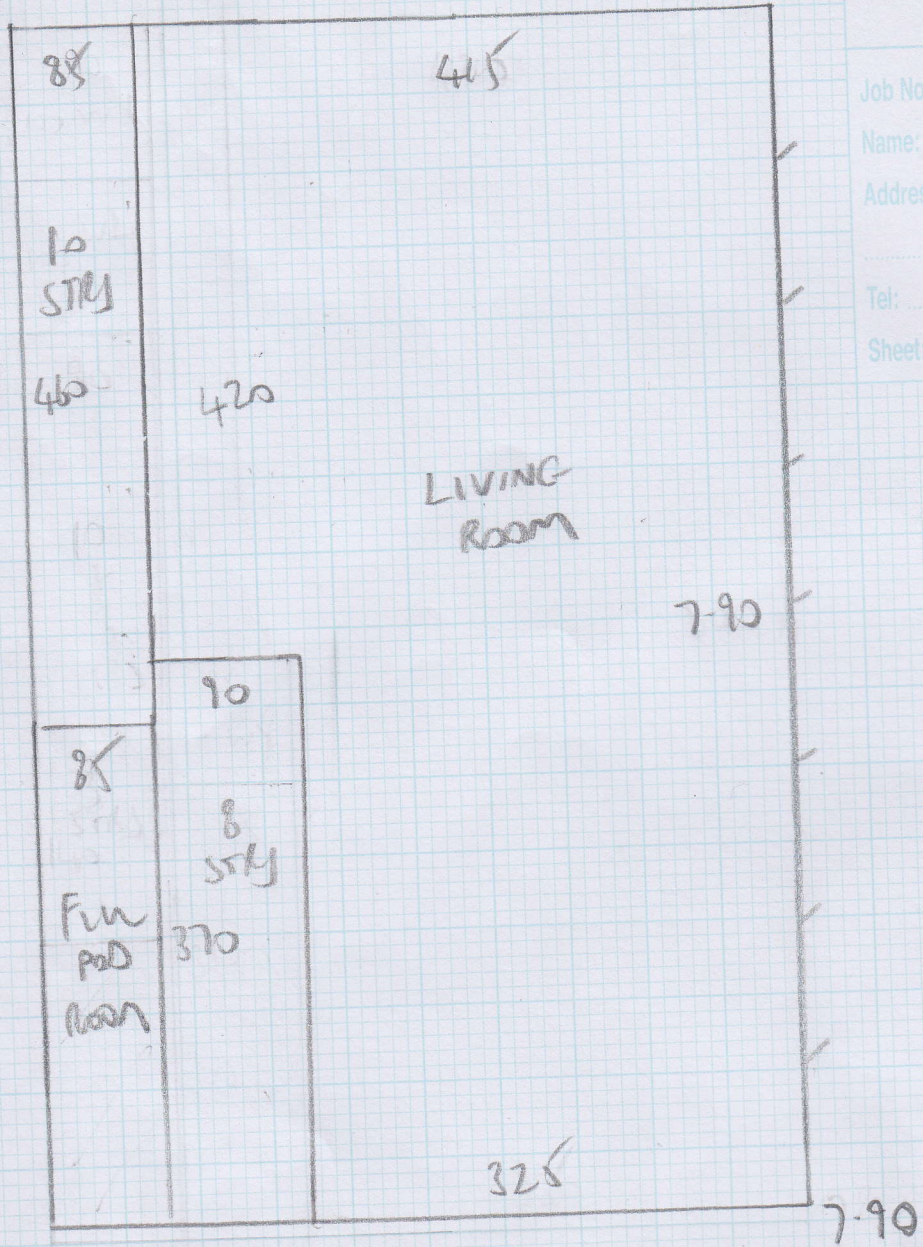

Job No: F23231

Name: MCINTOSH

Address: 8 ROSAVILLE ROAD
SW6 7BL

Tel:

Sheet: 3 OF 5

G/F

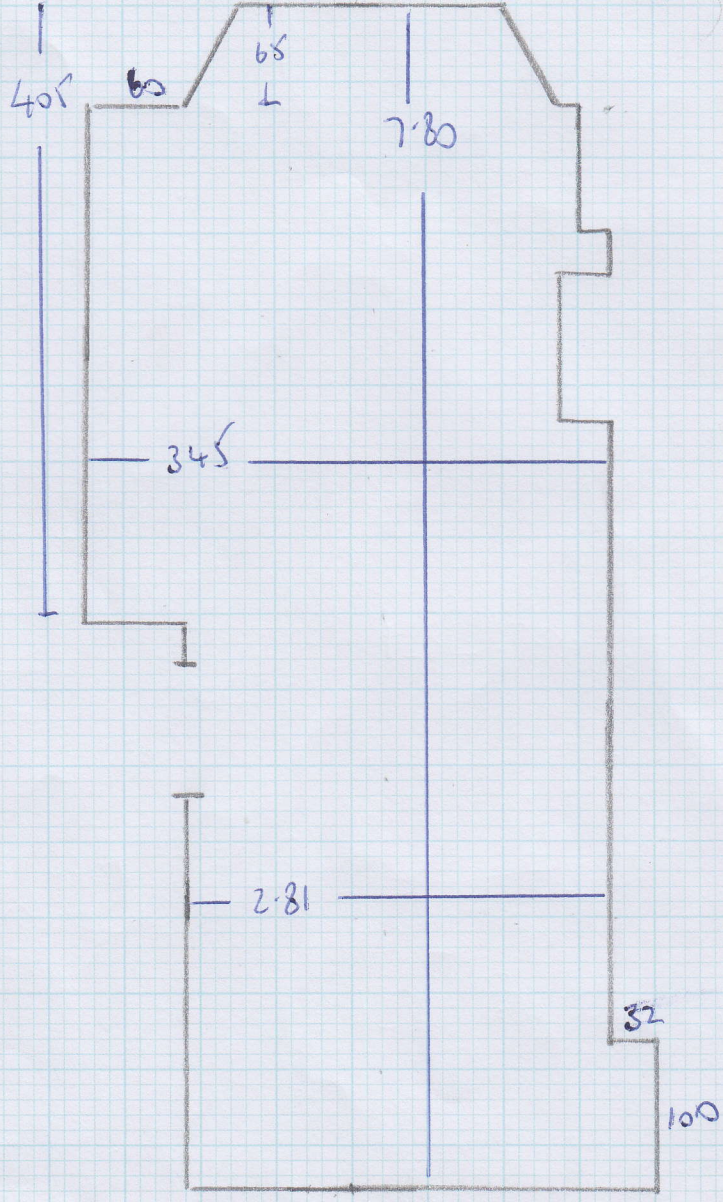

Job No: F23231
 Name: MCINTOSH
 Address: 8 ROSAVILLE ROAD
 SW6 7BL
 Tel:
 Sheet: 4 OF 5

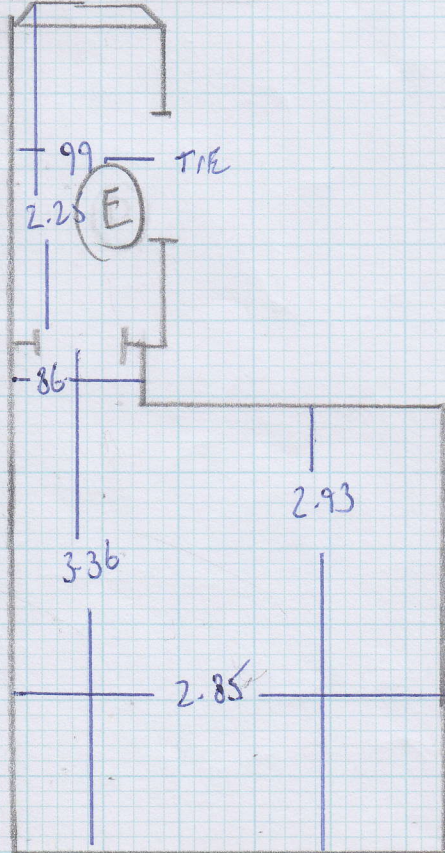
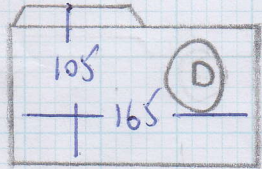
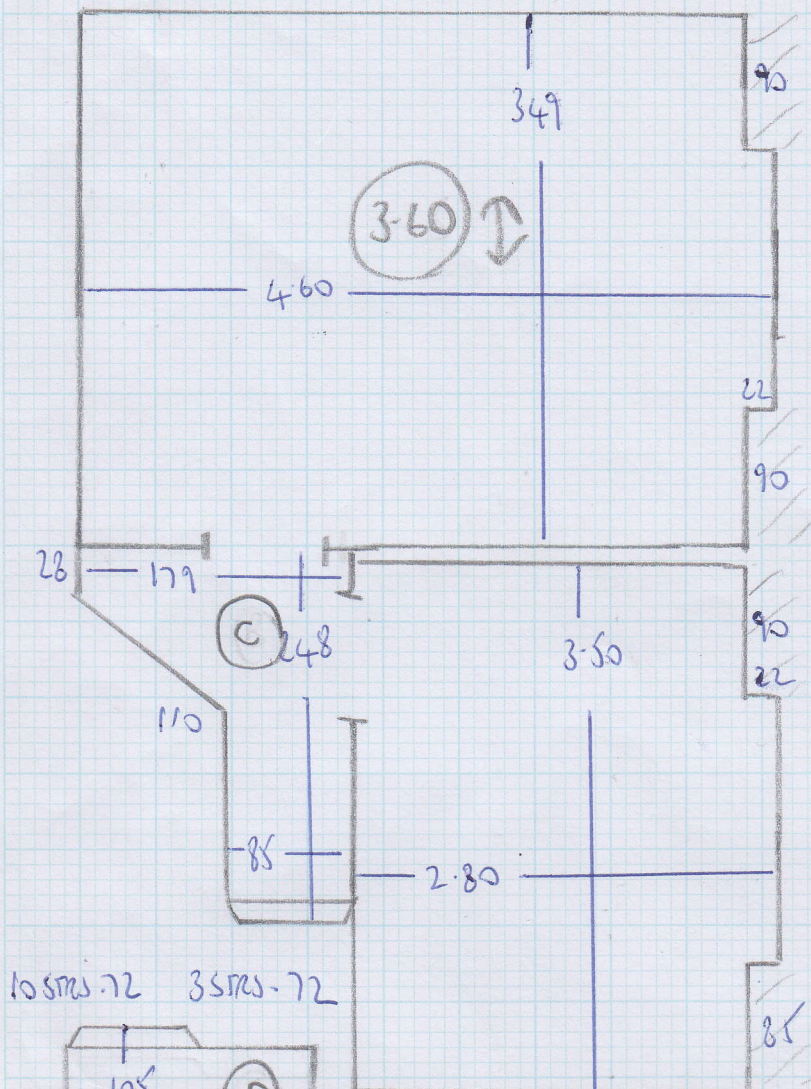

← underlay & sledge already down

SH 409
 Chelsea Cream 13

Job No: F23231

Name: MCINTOSH

Address: 8 ROSAVILLE ROAD

SW6 7BL

Tel:

Sheet: 5 OF 5

TOP FLOOR

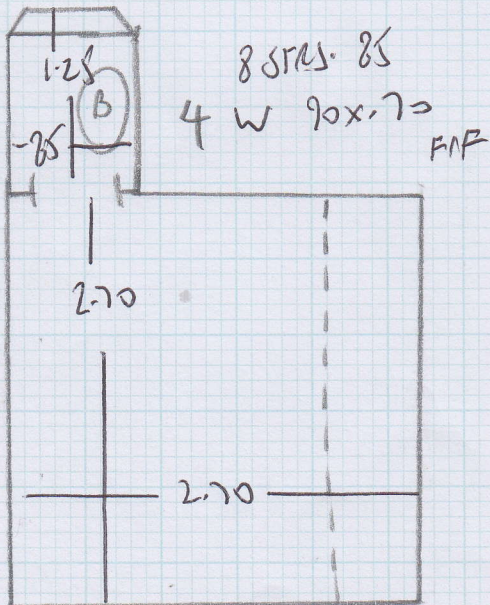
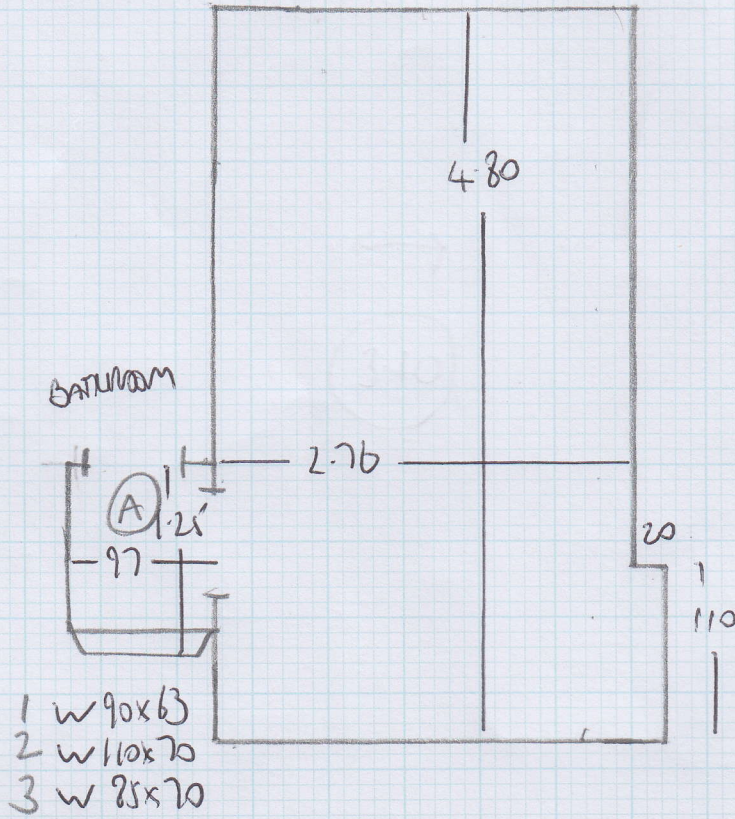

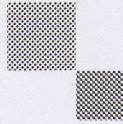

mrcarpet
DESIGNS FOR FLOORS

301 Munster Road
Fulham
SW6 6BJ

Tel Nr: 020-7381-1989
Fax Nr: 020-7385-4006

ROLL BREAKDOWN

Job No: F23231
Customer Name: McIntosh
Carpet: Imperial Velvet
Colour: 620/28

Roll 23.00m x 5.00m

Cutting Plan 1 7.90m x 5.00m
Cutting Plan 2 6.60m x 5.00m
Cutting Plan 3 4.90m x 5.00m
Front Bedroom 3.60m x 5.00m

=====
Total 23.00m x 4.00m
=====

Many Thanks

John

* Please cut 3-60x5MTR *
Last *