

Job No: F23845
Name: STISTED
Address: 19 DAVENHURST ST
SW6 6SA
Tel:
Sheet: 1 of 4

6.90m
5.40m
3.80m

GOODWOOD
600-211

$$16.10m \times 5.00m = 80.5m^2$$

2nd Phase
Living Room
3.90 x 5MTR

Job No: F23845
 Name: STISTED
 Address: 19 DANEMURST ST
 SW6 6SA
 Tel:
 Sheet: 2 of 4

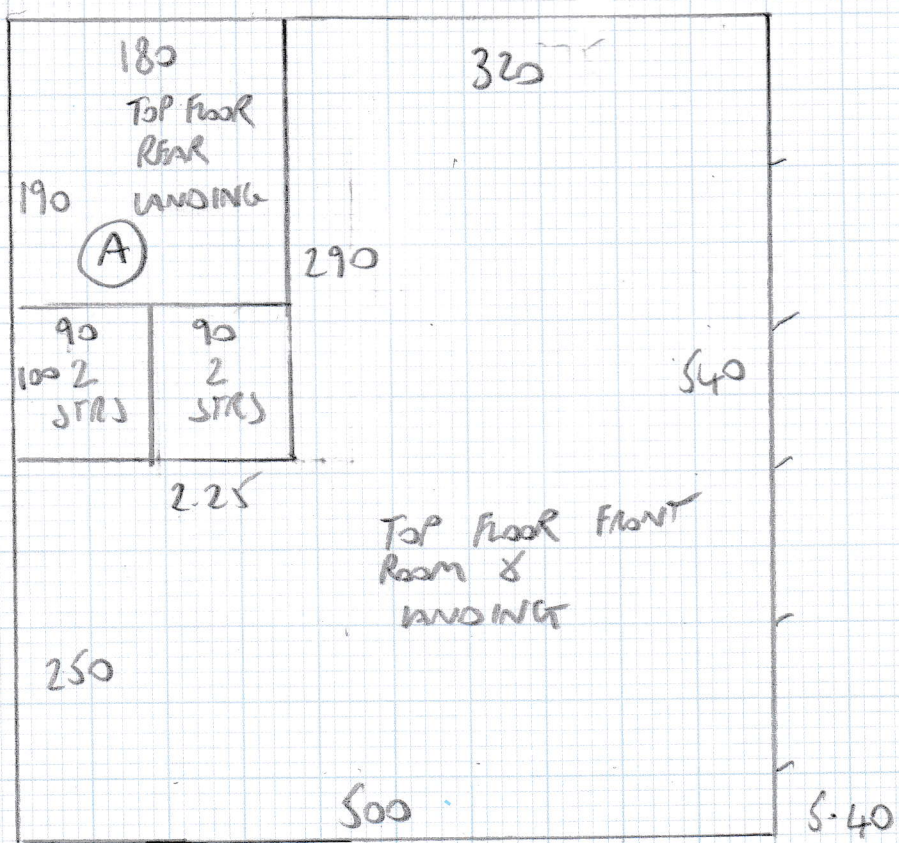
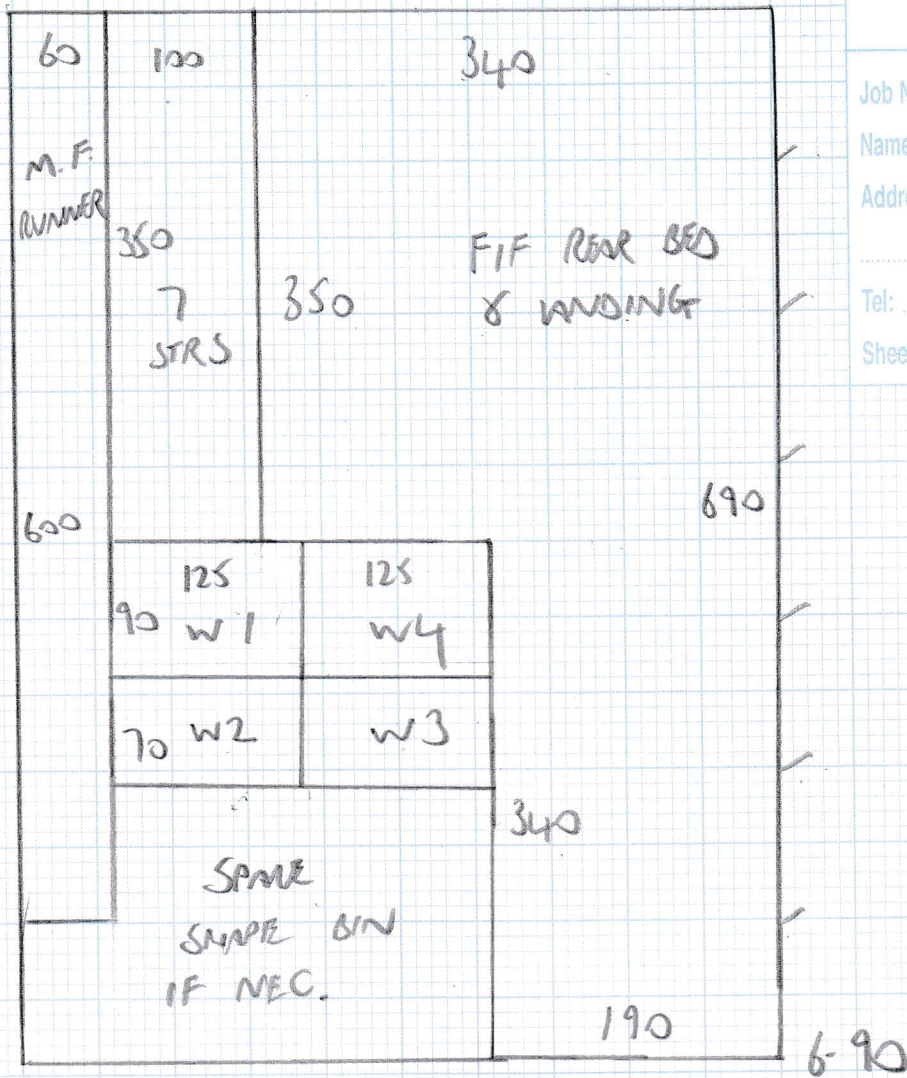

FIRST FLOOR



Job No: F2384S
 Name: STISTED
 Address: 19 DAVEHURST ST
 SW6 6SA
 Tel: _____
 Sheet: 3 of 4

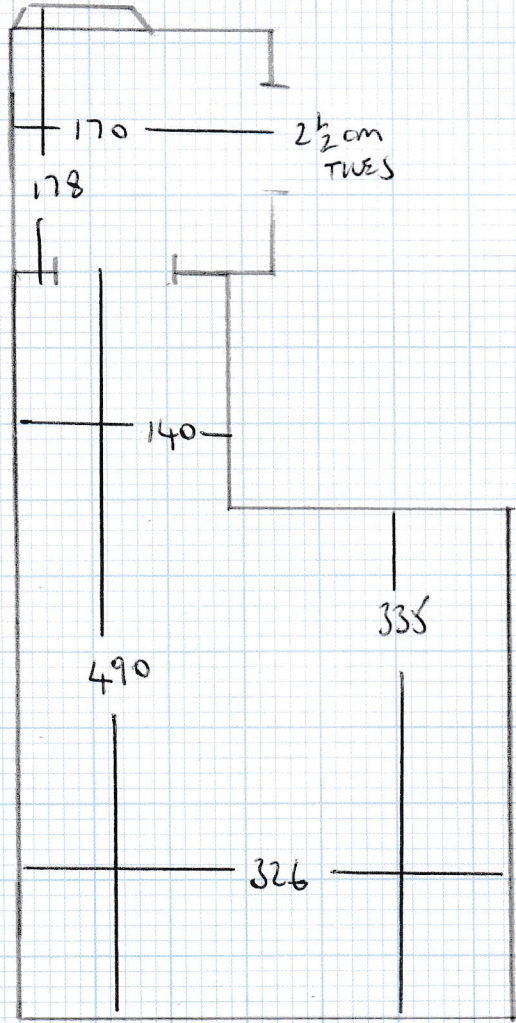
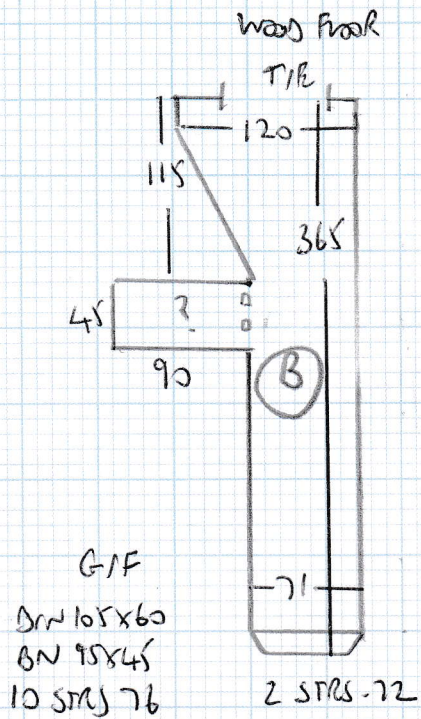

Job No: F23845

Name: STISTED

Address: 19 DUNEHURST ST
SW6 6SA

Tel:

Sheet: 4 of 4

TOP FLOOR

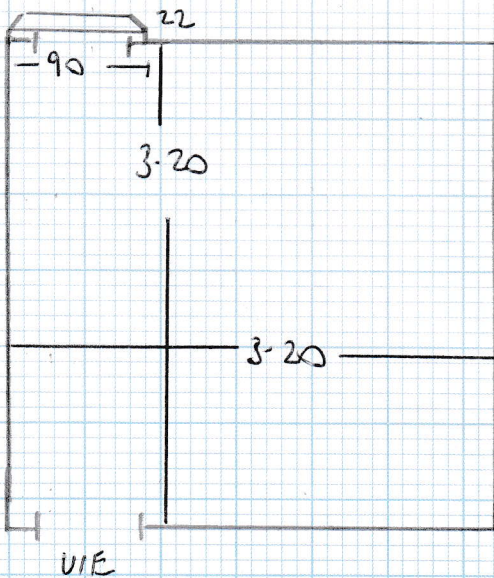
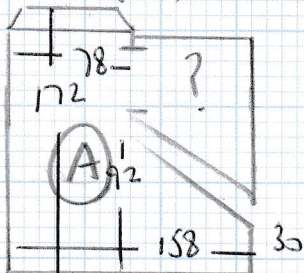
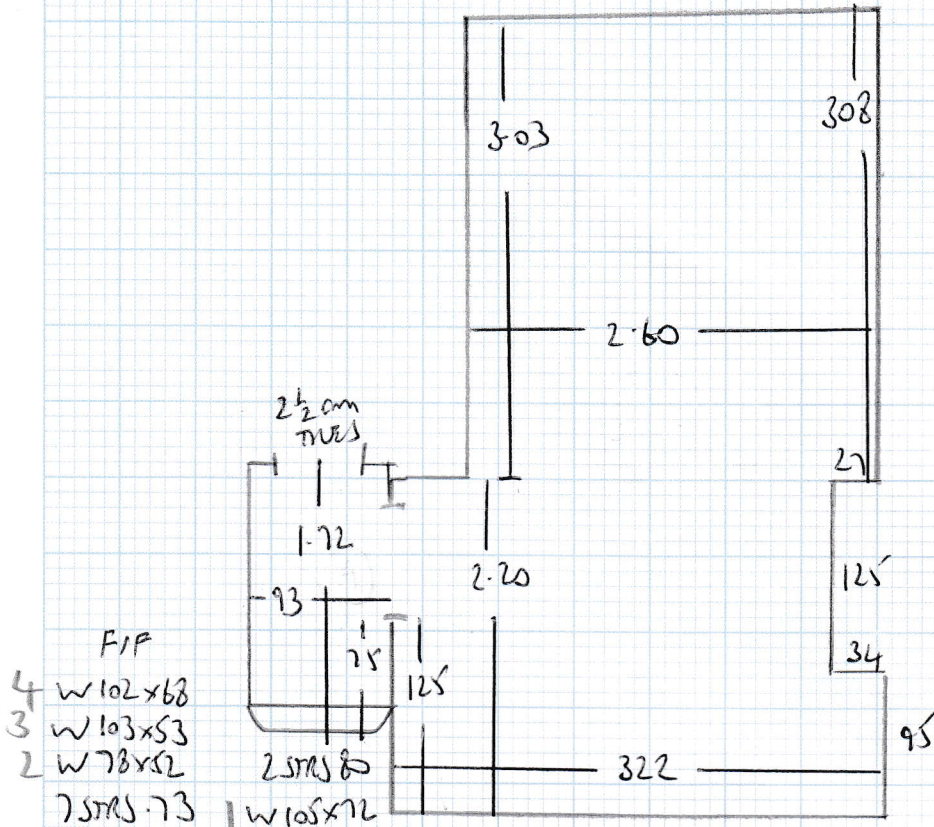

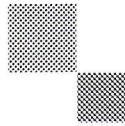

mrcarpet
DESIGNS FOR FLOORS

301 Munster Road
Fulham
SW6 6BJ

Tel Nr: 020-7381-1989
Fax Nr: 020-7385-4006

ROLL BREAKDOWN

Job No: F23751
Customer Name: Stisted
Carpet: Goodwood
Colour: GOO-211

20.00m x 5.00m ordered with Lano Carpets

Cutting Plan 1 6.90m x 5.00m
Cutting Plan 2 5.40m x 5.00m
Cutting Plan 3 3.80m x 5.00m
Living Room 3.90m x 5.00m – CUT LAST!!

=====
Total 20.00m x 5.00m
=====

Many Thanks

John