

Job No: F25/61
 Name: USER CONTRACTS
 Address: 133 HAMBROST SWB BPL
 Tel:
 Sheet: 1 of 4

- 4:30 - MASTER BEDROOM
- 5:50 - CIP
- 7:70 - CIP
- 2:30 - CIP

$19.80M \times 5.00M = 99M^2$

SLOANE TWIST SUPER (S0⁰²)

SLO - S03S TUNDRA

Job No: F2S161
 Name: UBER CONTRACTS
 Address: 133 HARBOUR ST
 SW6 6PL
 Tel:
 Sheet: 2 of 4

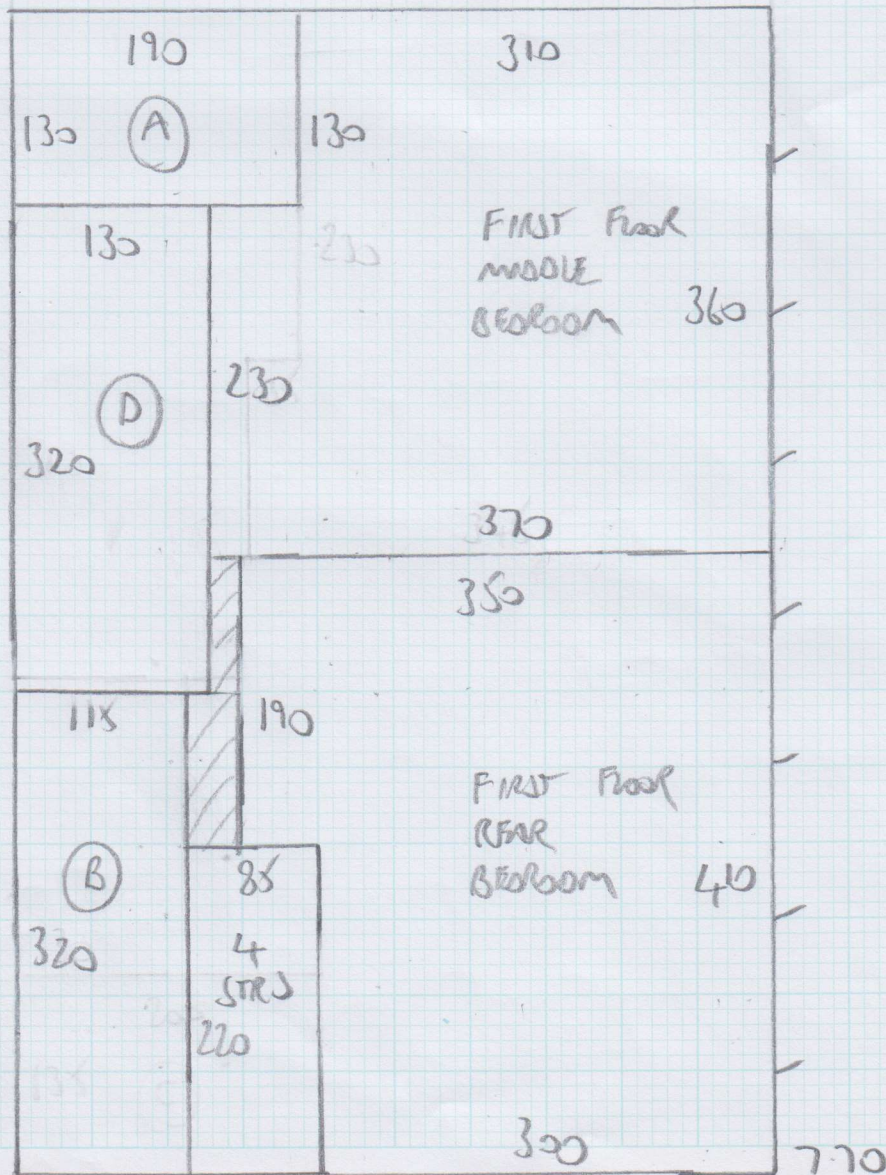
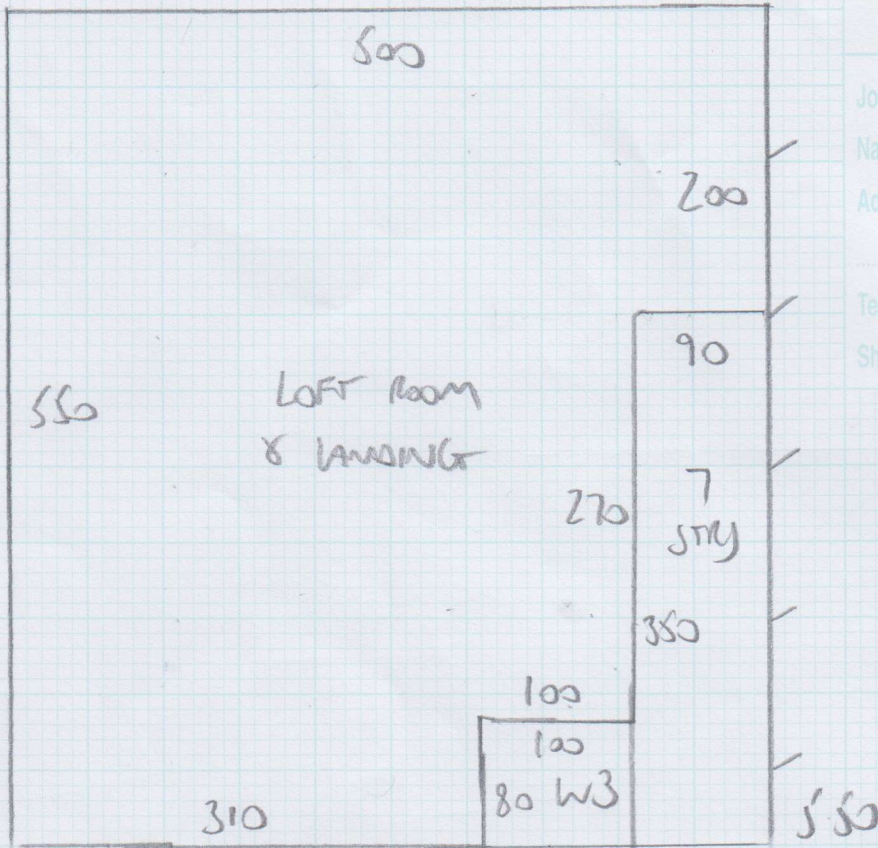

Job No: F25161
 Name: UBER CONTRACTS
 Address: 133 HARBOUR ST
 SW6 6PL
 Tel:
 Sheet: 3 of 4

FIRST FLOOR

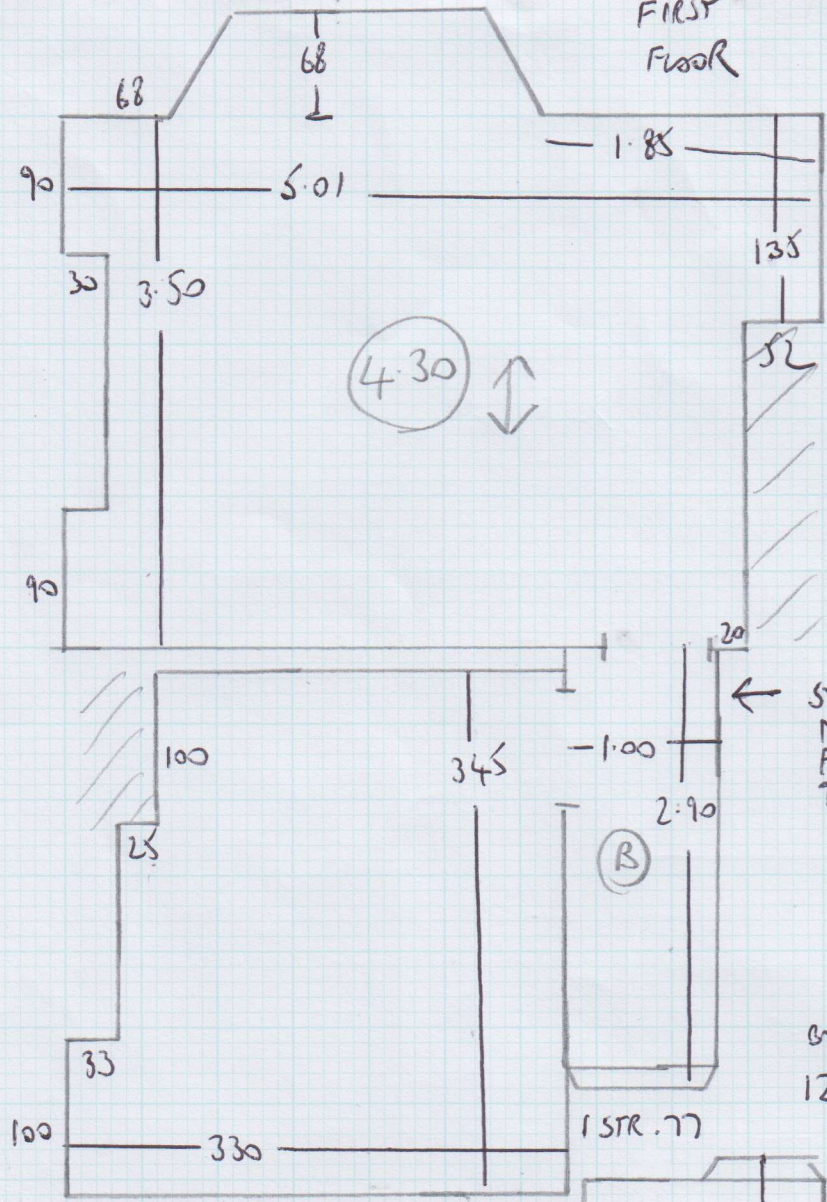

G/F
 6W 100x50
 12 STR. 78

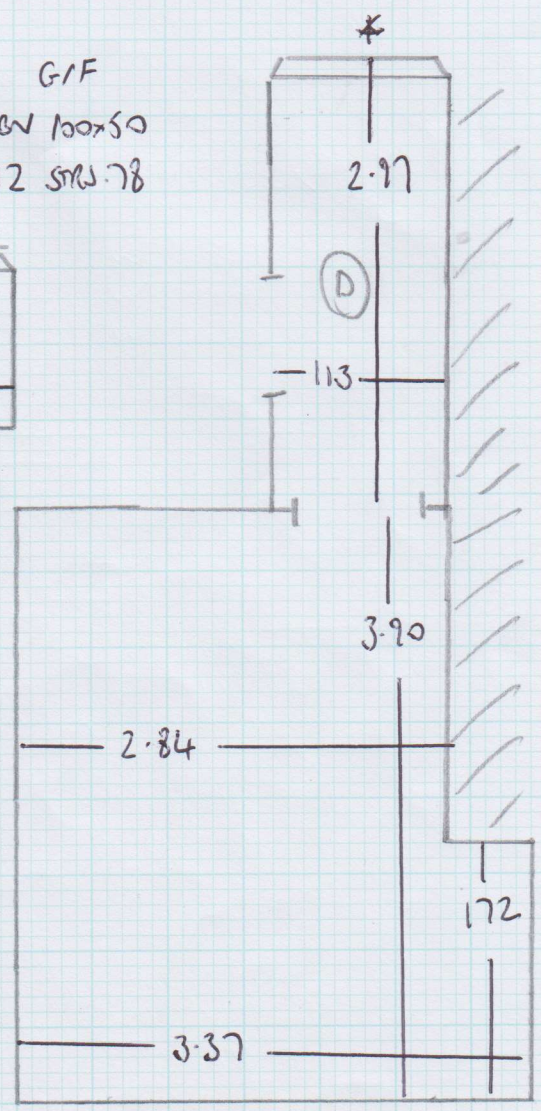
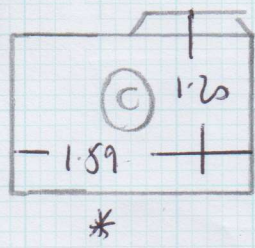

3740-15
 3500

Job No: F2S161

Name: USER CONTRACTS

Address: 133 HARBOUR ST
SW6 6PL

Tel:

Sheet: 4 of 4

TOP FLOOR

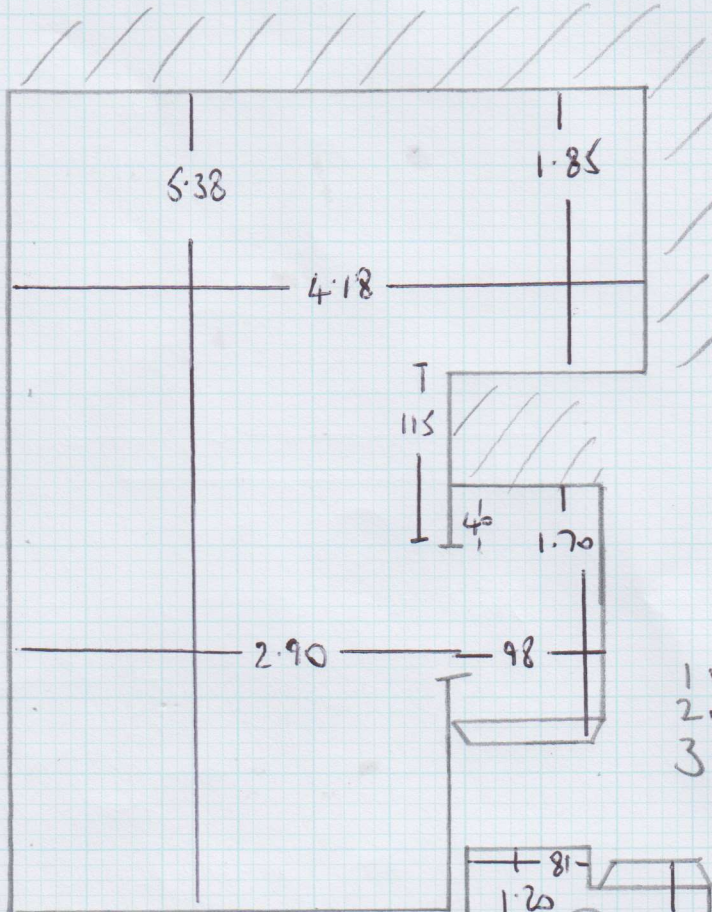

FIRST FLOOR

- 1 W 72x69
- 2 W 103x68
- 3 W 88x60
- 9 STRS 73

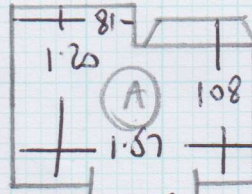

BUTT
TO DUES
15mm
BATHROOM