

Job No: F25235  
 Name: WEST  
 Address: TOP FLAT  
 687 FULTON RD SW6 SW7  
 Tel:  
 Sheet: 1 of 2

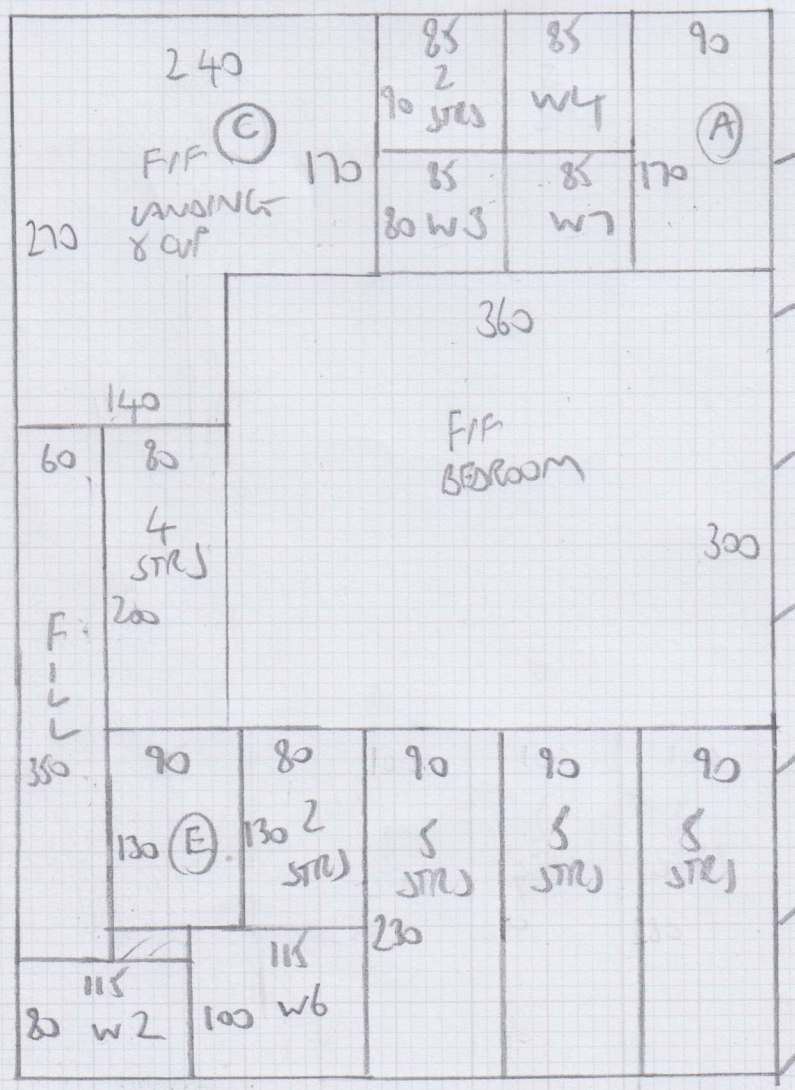
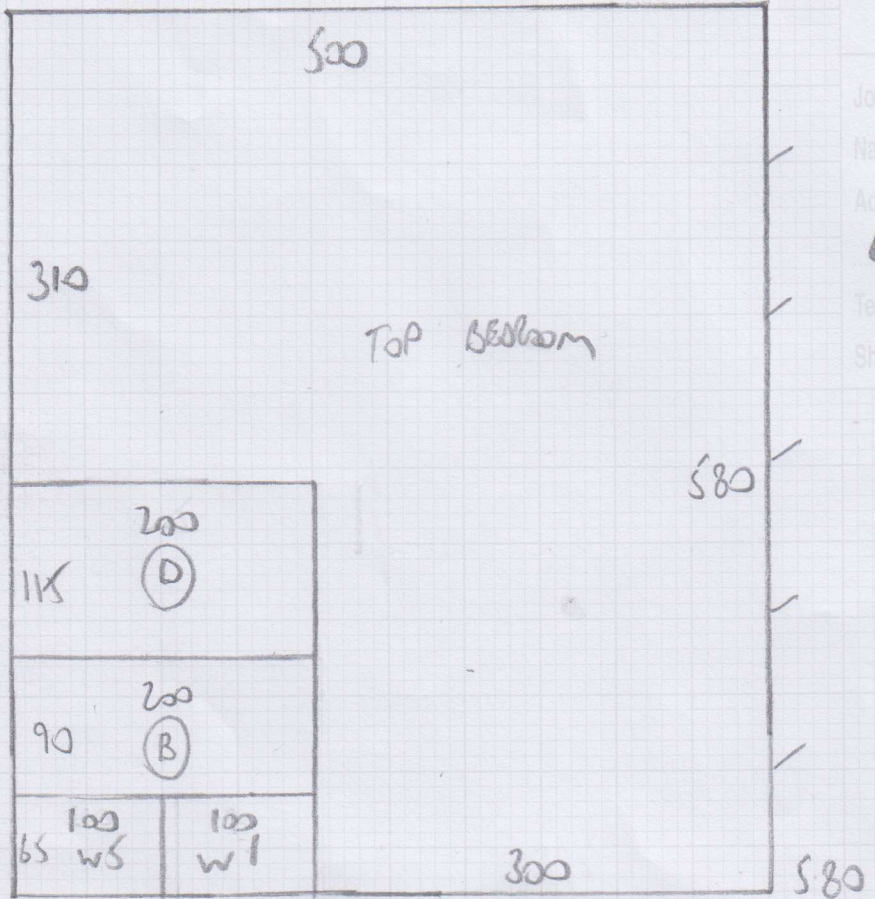

Stock NAT 4  
 - HC510  
 5.80 } C/P  
 7.00 }  
 3.90 - LIV RM  
 -----  
 16.70m x 5.00  
 = 83.5m<sup>2</sup>

FR4819

TOP Floor

UIE

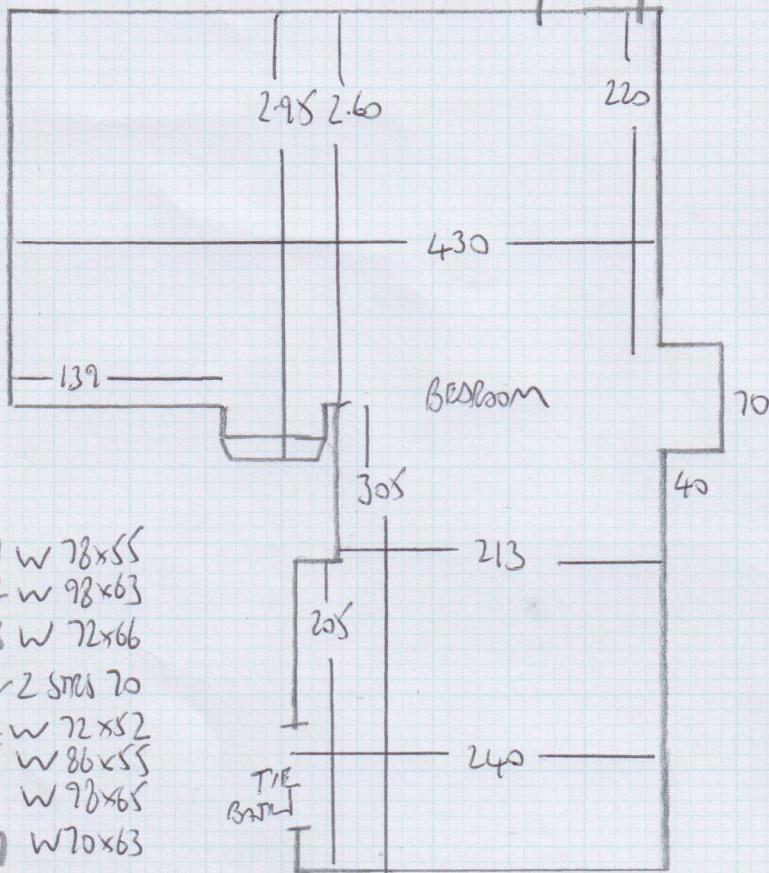

- / 1 W 78x55
- / 2 W 98x63
- / 3 W 72x66
- / 2 STPS 70
- / 4 W 72x52
- / 5 W 86x55
- / 6 W 98x65
- / 7 W 70x63
- / 2 STPS 70

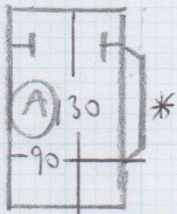

/ 4 STPS 70

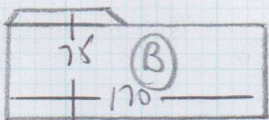

ROOF TERRACE

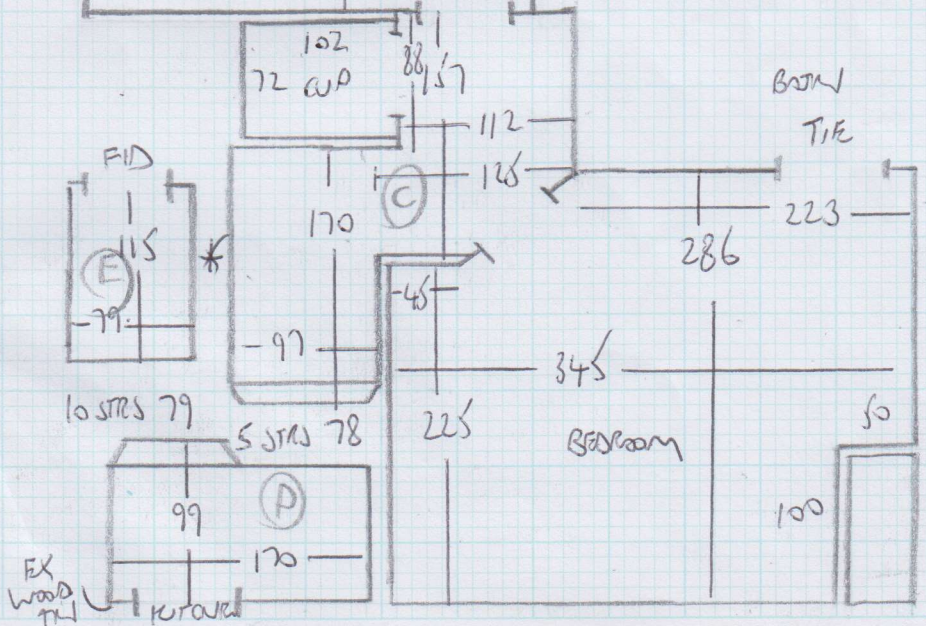
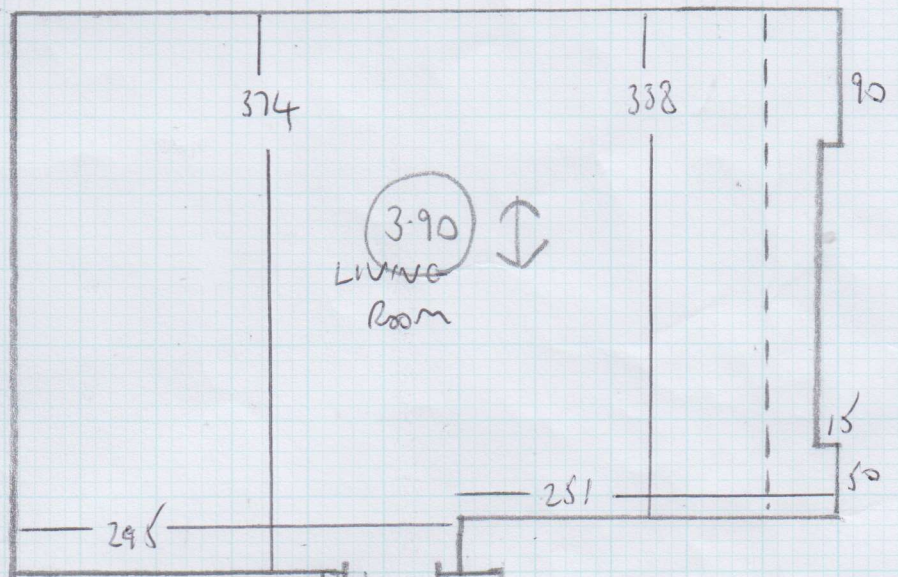

mrcarpets  
SPECIALISTS FOR EXPORTS

Job No: WEST F25235

Name: TOP FWT 687 FULHAM ROAD

Address: SW6 SW7

Tel:

Sheet: 2 of 2

Job No: F25235  
 Name: WEST  
 Address: TOP FLAT  
 687 FULTON RD SWB SUJ  
 Tel:  
 Sheet: of:

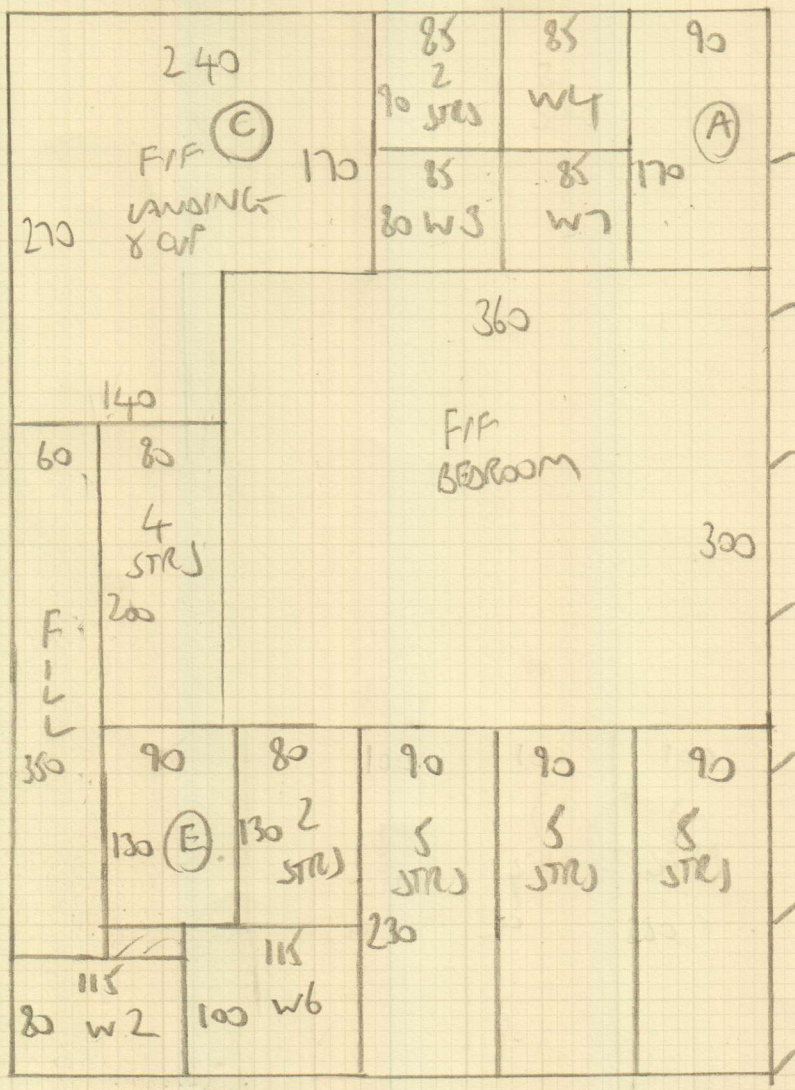
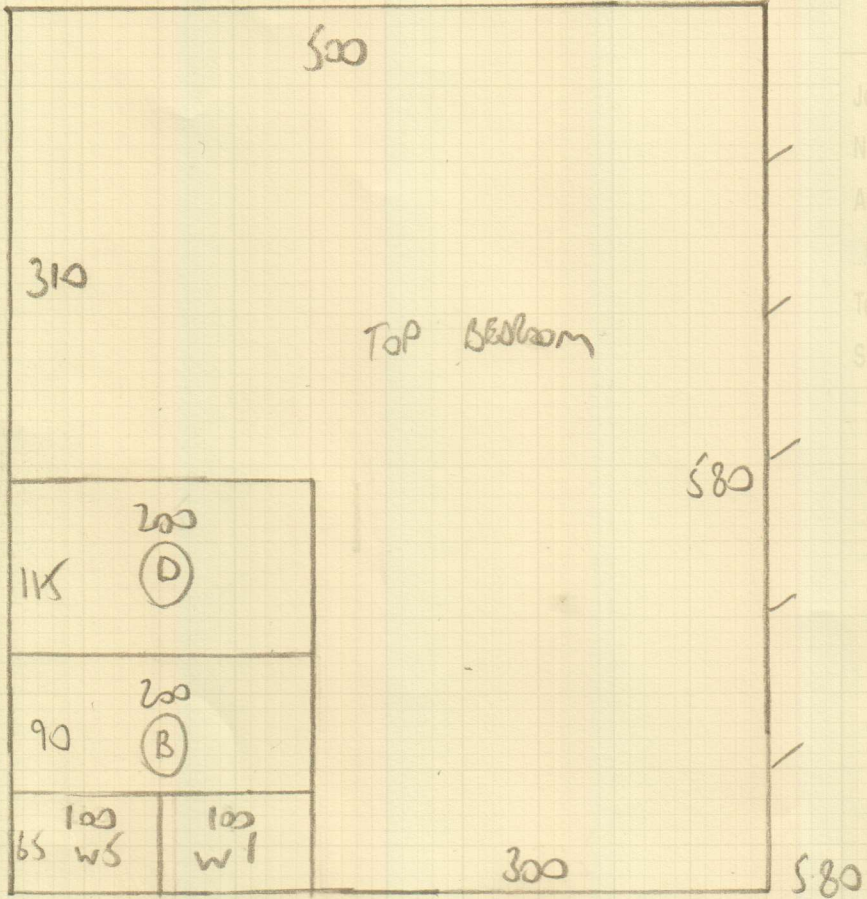

5.80 } CIP  
 7.00 }  
 3.90 - LIV RM  
 -----  
 16.70m x 5.00  
 = 83.5m<sup>2</sup>

TOP FLOOR

UIE

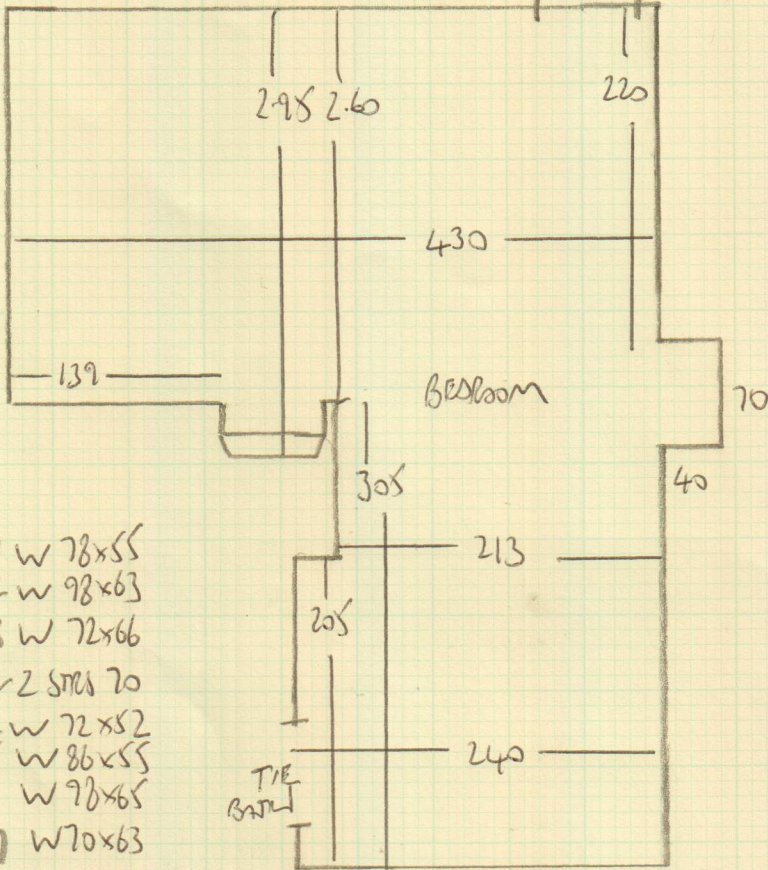

- / 1 W 78x55
- / 2 W 98x63
- / 3 W 72x66
- / 2 STPS 70
- / 4 W 72x52
- / 5 W 86x55
- / 6 W 98x65
- / 7 W 70x63
- / 2 STPS 70

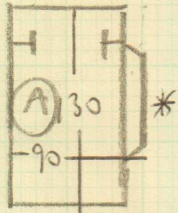

/ 4 STPS 70

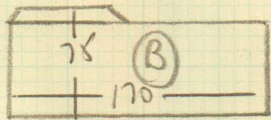

ROOF TERRACE

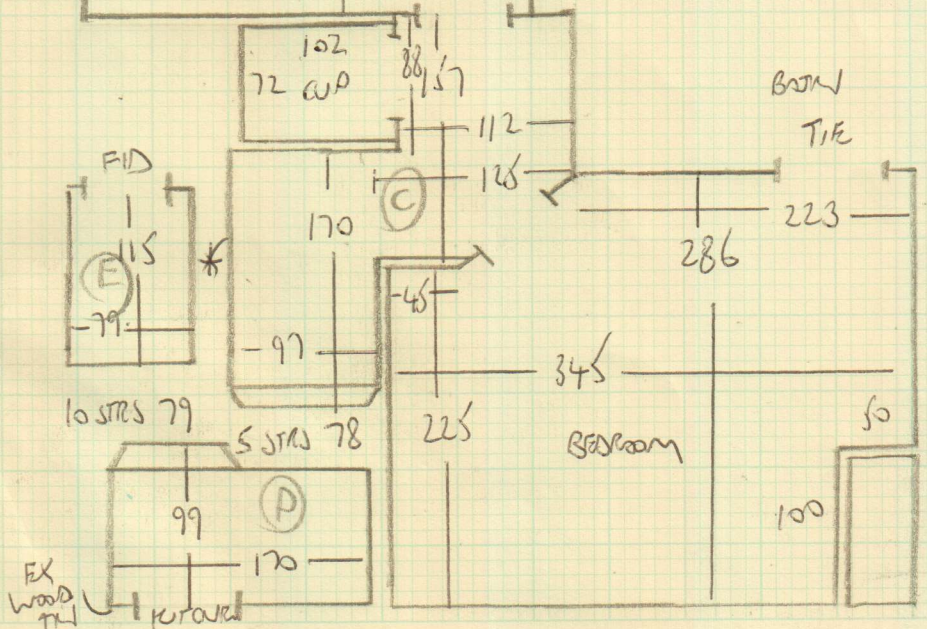
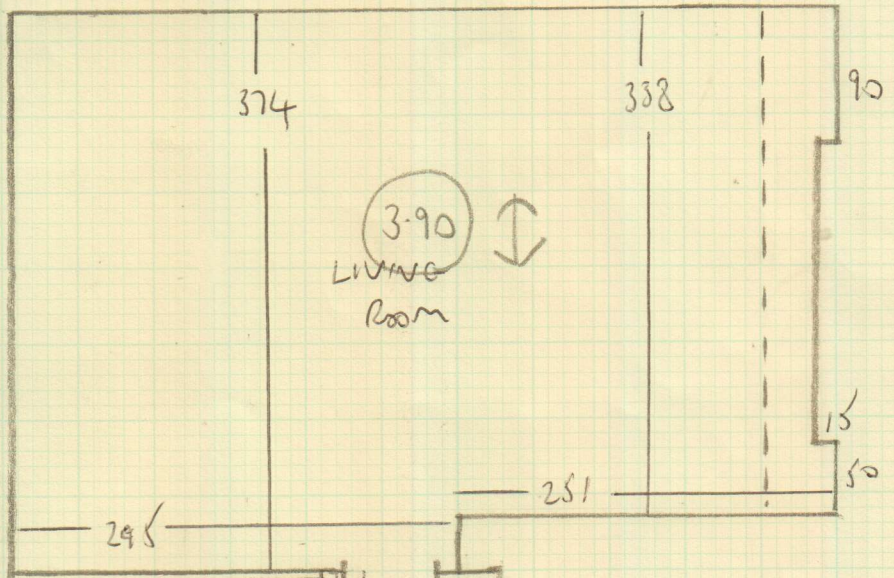

mrcarpets  
 Job No: WEST F25235  
 Name: TOP FLOOR 687 FULHAM ROAD  
 Address: SW6 SW7  
 Tel:  
 Sheet: of: