

Job No: F27128
 Name: WALTERS
 Address: 15 CLIVEDEN PLACE
 SW1W 8LA
 Tel:
 Sheet: 1 OF 5

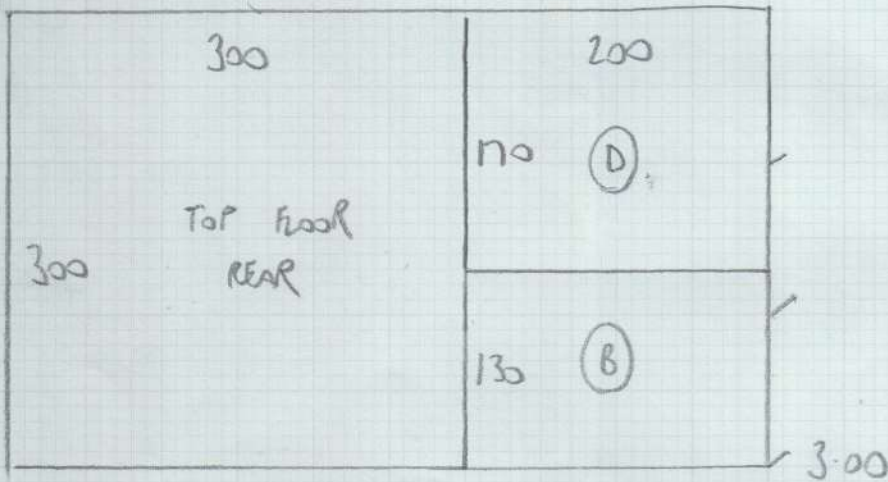
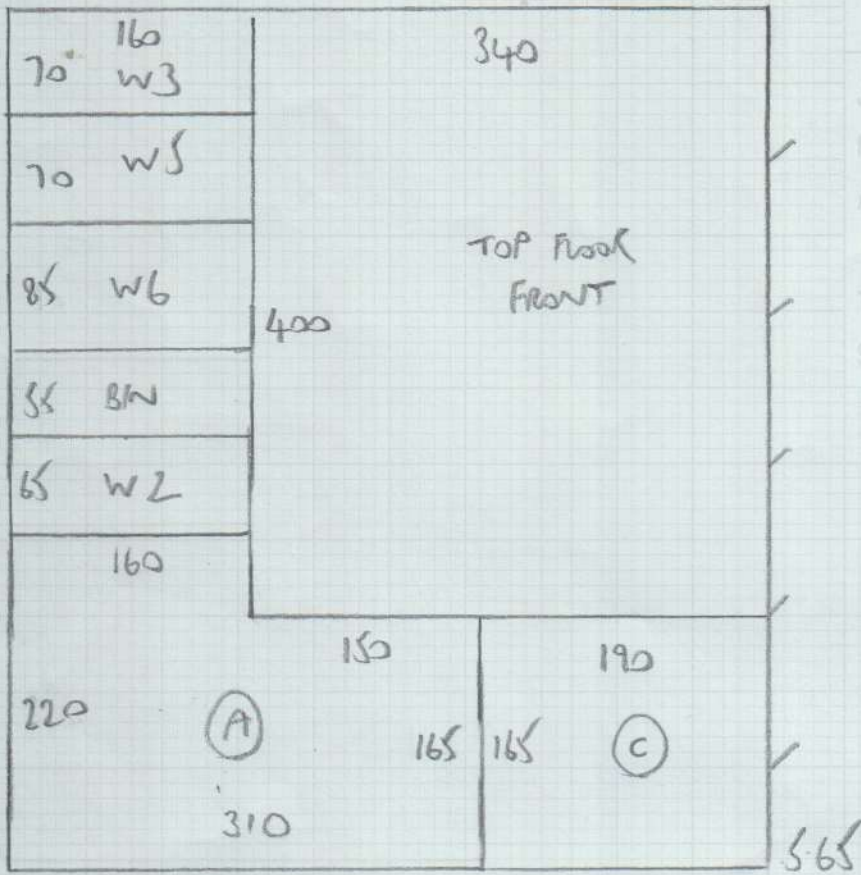

5.65 - CIP

3.00 - CIP

6.00 - CIP

4.55 - MASTER BED

19.20m x 5.20m

2.10 x SMTR

Basement + stairs

MONTREU X MON-326

(CASHMERE WEST COAST GREY
830)

Job No: F27128
 Name: WALTERS
 Address: 15 CLIVEDEN PLACE
 SW1W 8LA
 Tel:
 Sheet: 2 of 5

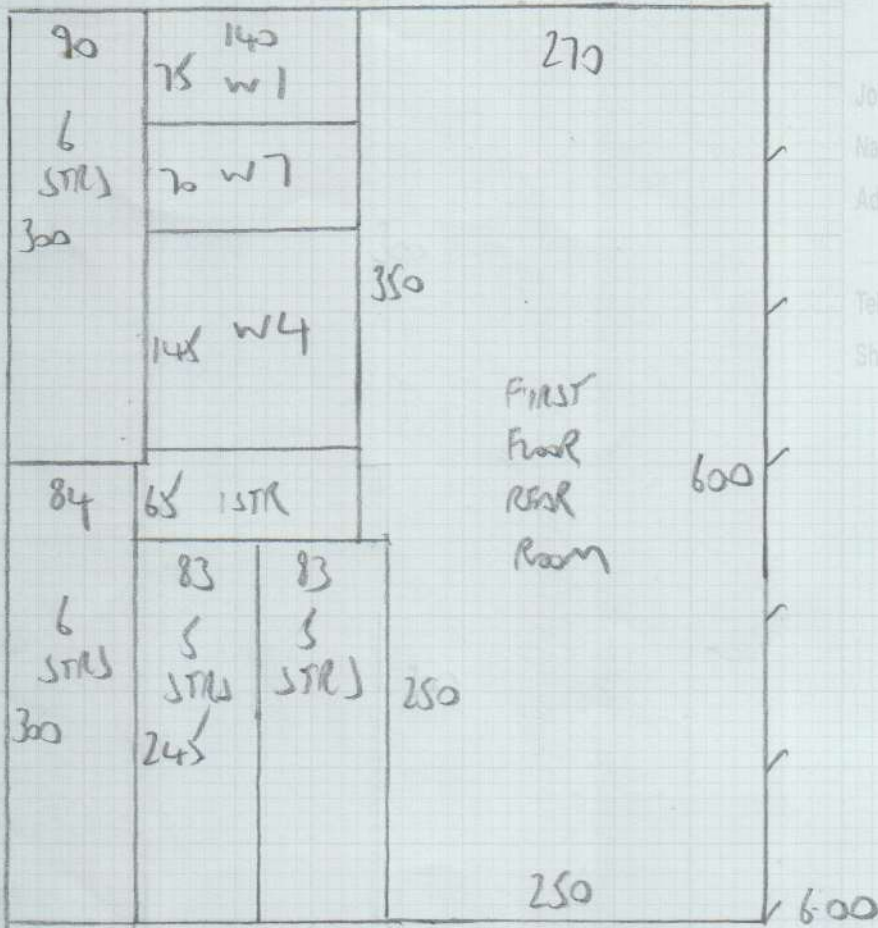

RUNNERS CARPETS - 1ST

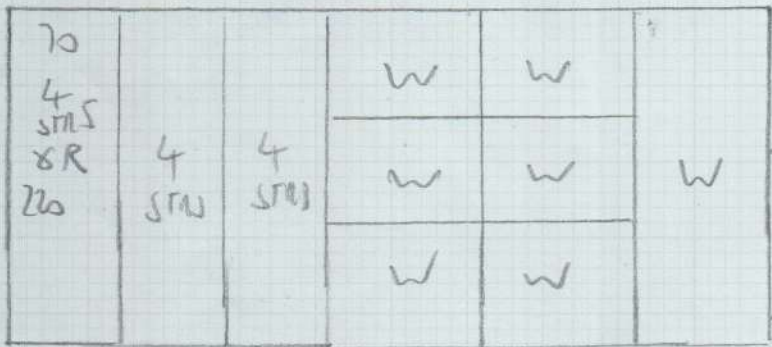

MACEDONIA
 (STRIDE)
 609/28

$220 \times 500 = 110000 \text{ cm}^2$

BASMENT

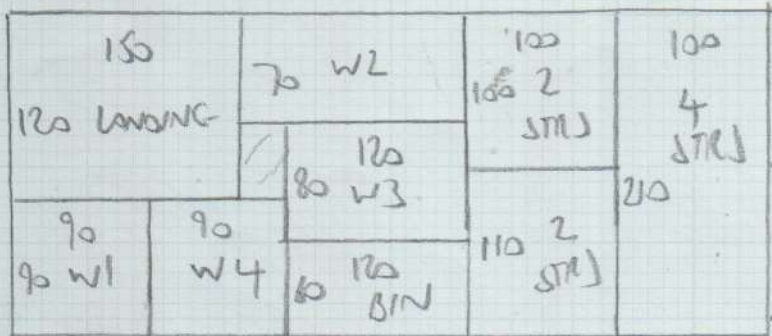

MONTREUX
 MON - 326

$210 \times 500 = 105000 \text{ cm}^2$

FIRST FLOOR

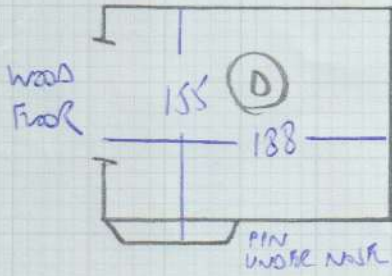

- RUNNER
- 150R 75x15
 - 4 STRS 76x47
 - W 85x55
 - W 115x60
 - W 85x152 - STRAPPED
 - W 111x46
 - W 116x74
 - W 77x60
 - 7 STRS 76x47
 - GIF

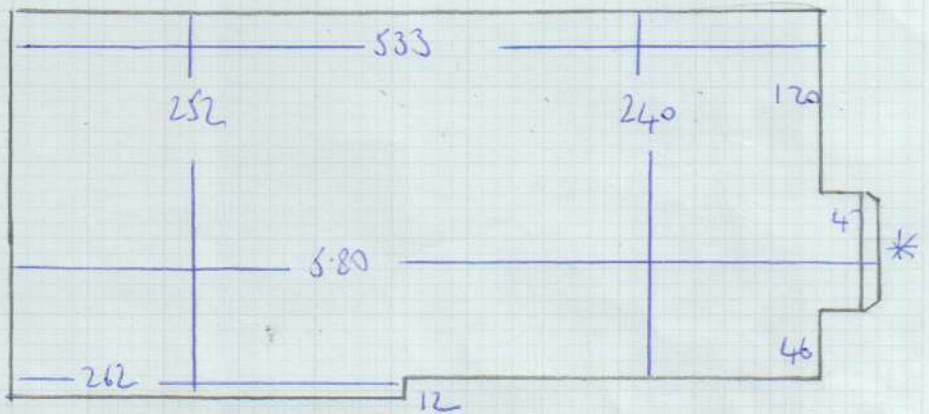

GIF REAR HALL

(BUTT TO TILES)

- 1 STR 80x30
- 1 STR 80

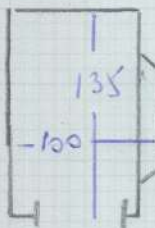

- 1 W 85x56
- 2 W 112x60
- 3 W 110x76
- 4 W 80x56
- 6 STRS 80
- BN 105x47
- BASINMENT

BASEMENT STAIRS

PLAIN

Job No: F27128

Name: WALTERS

Address: 15 CLIVENEN PLACE
SW1W 2LA

Tel:

Sheet: 3 of 5

SECOND FLOOR

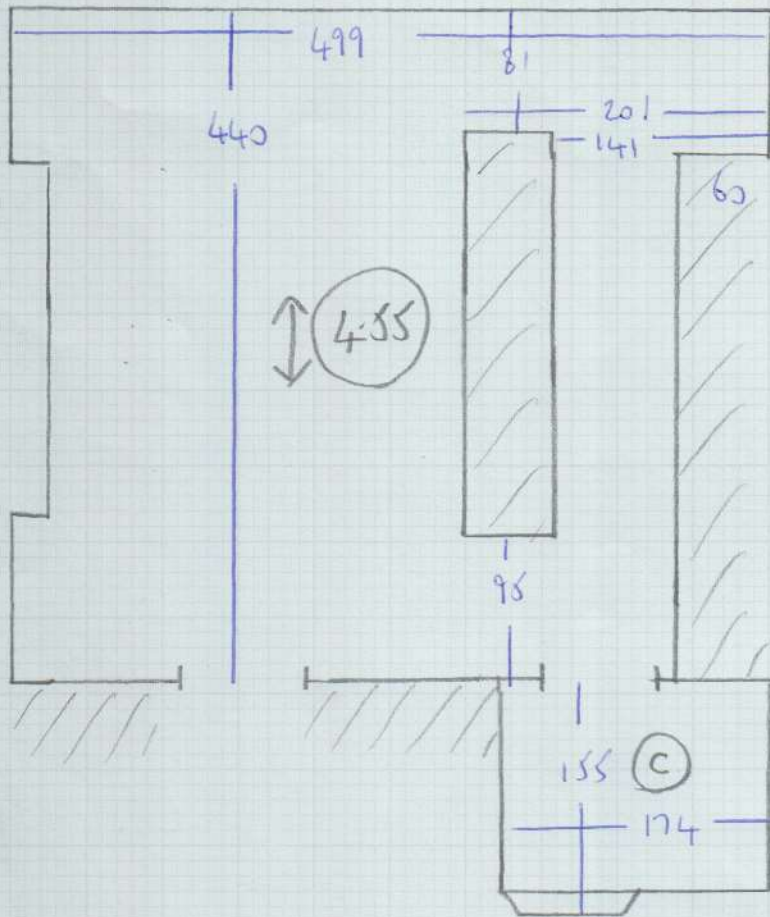

mrcarpets
 Job No: F27128
 Name: WAJELI
 Address: 15 CLIVEDEN PLACE
 SW1W 8LA
 Tel:
 Sheet: 4 OF 5

- 5 STRS 76x47
- 2W 84x54
- 3W 115x58
- BATHROOM STEP (WOOD) 80x60 - 4W 95x137
- 5W 113x60
- 6W 115x75
- 7W 77x58
- 5 STRS 78x47
- 6W 102x47

Job No: F21128
 Name: WAJERS
 Address: 15 CLIVEDEN PLACE
 SW1W 8LA
 Tel:
 Sheet: 5 of 5

TOP FLOOR

