

Job No: F29092
 Name: ZNOWSKI
 Address: 14 FEUSEN STREET
 SW6 SAF
 Tel:
 Sheet: 1 of 3

FIRST FLOOR

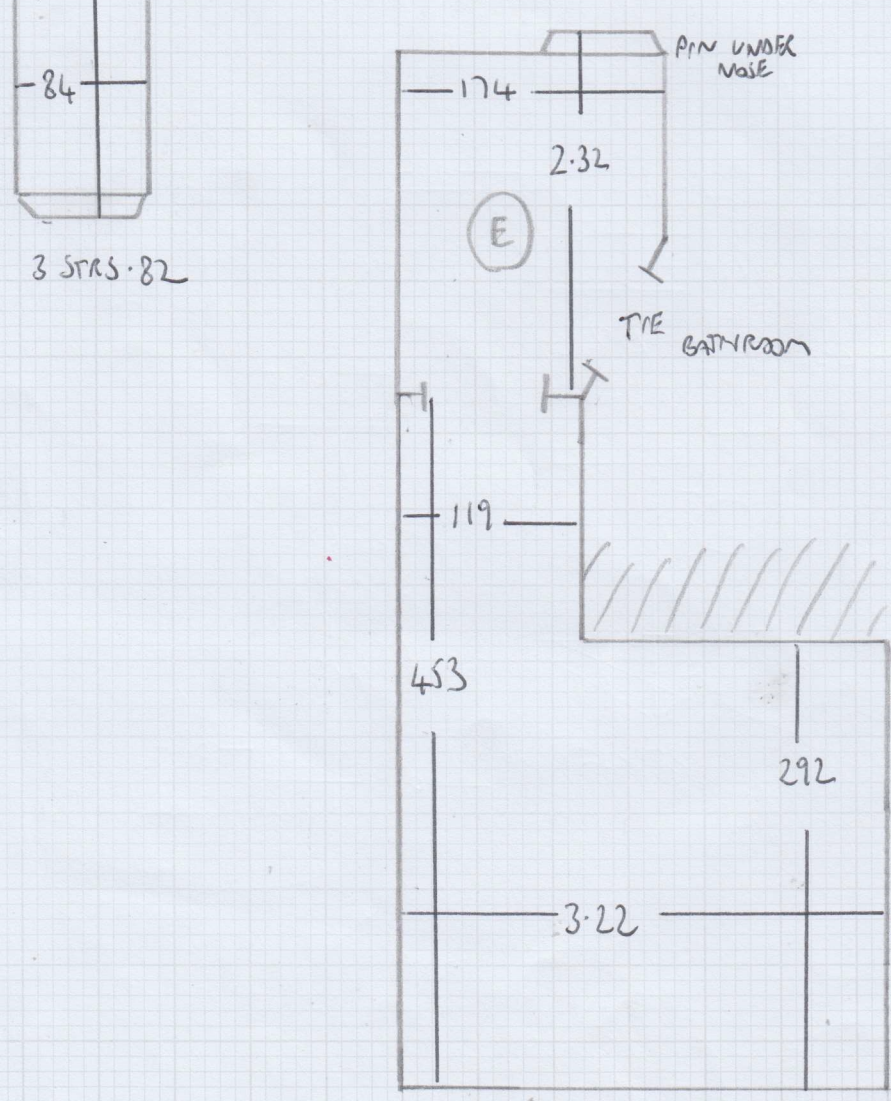
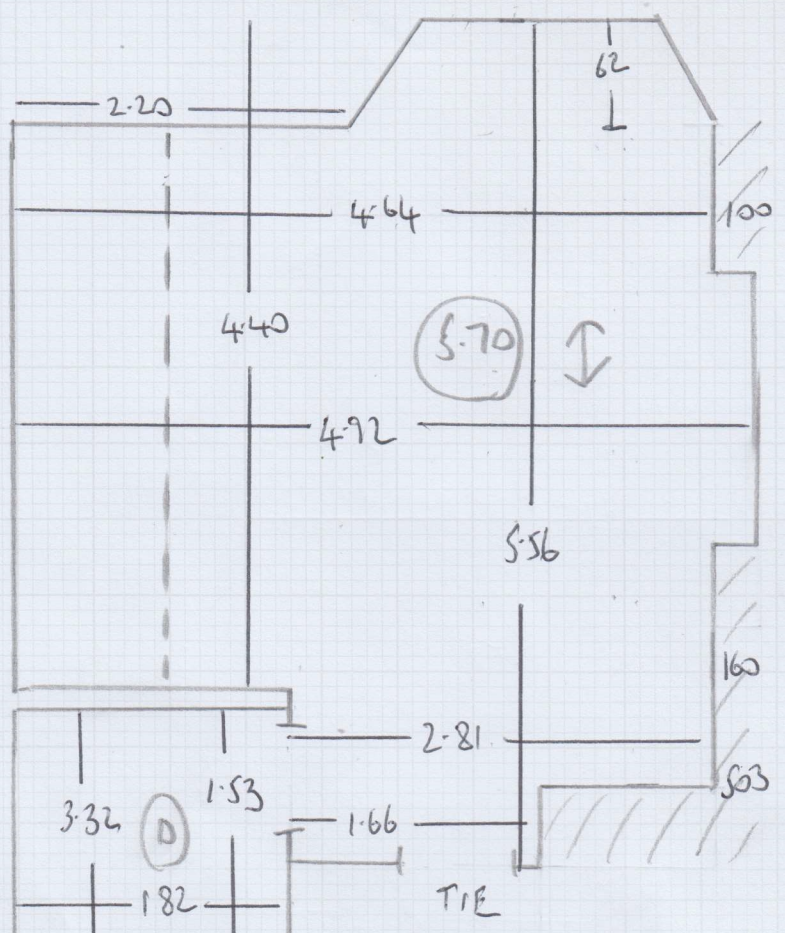

MAIN FLIGHT
 RISER 79x16
 11 STRS .81
 BN AS STAIR
 G/F

EXISTING
 RUNNER
 .62

3 STRS .82

Job No: F29092

Name: ZNOWSKI

Address: 14 FREUDEN STREET
SW6 5AF

Tel:

Sheet: 2 of 3

TOP FLOOR

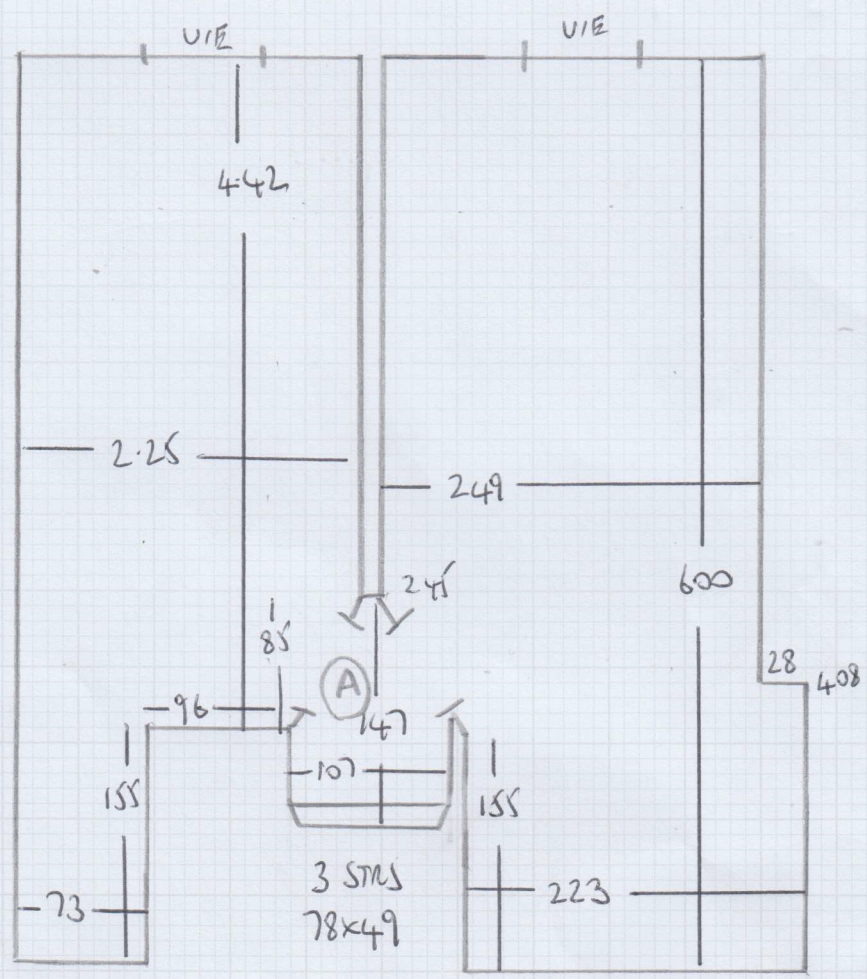

FIR
10 STRS - 81

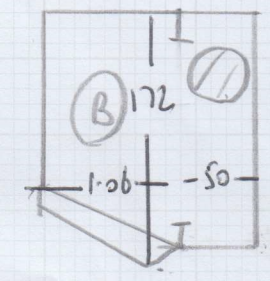
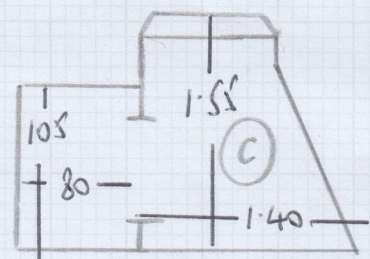

W 1.41 x 78

Job No: F29092
 Name: ZNOWSKI
 Address: 14 FEWEN ST
 SW6 SAF
 Tel:
 Sheet: 3 of 3

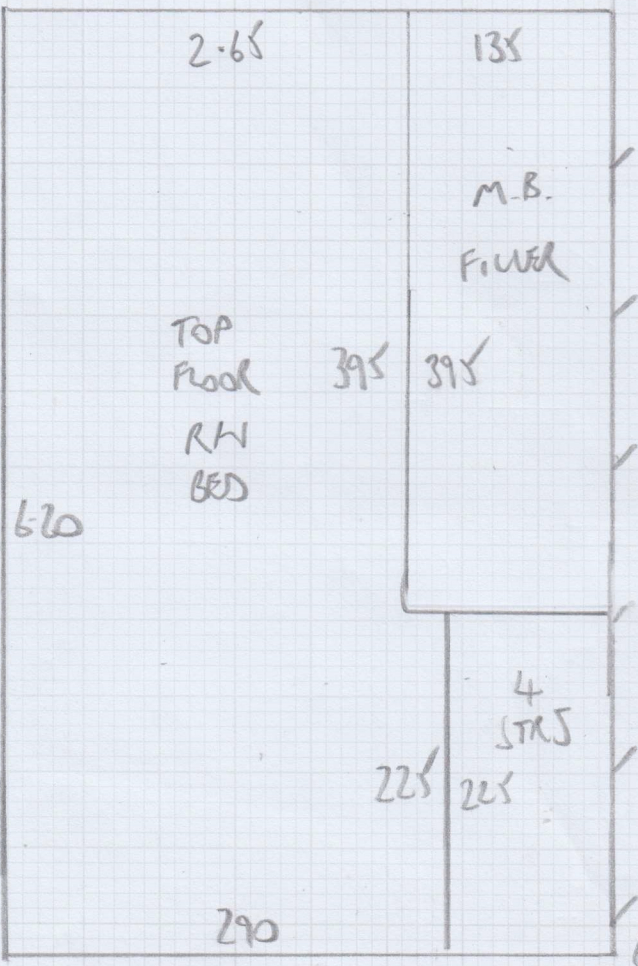
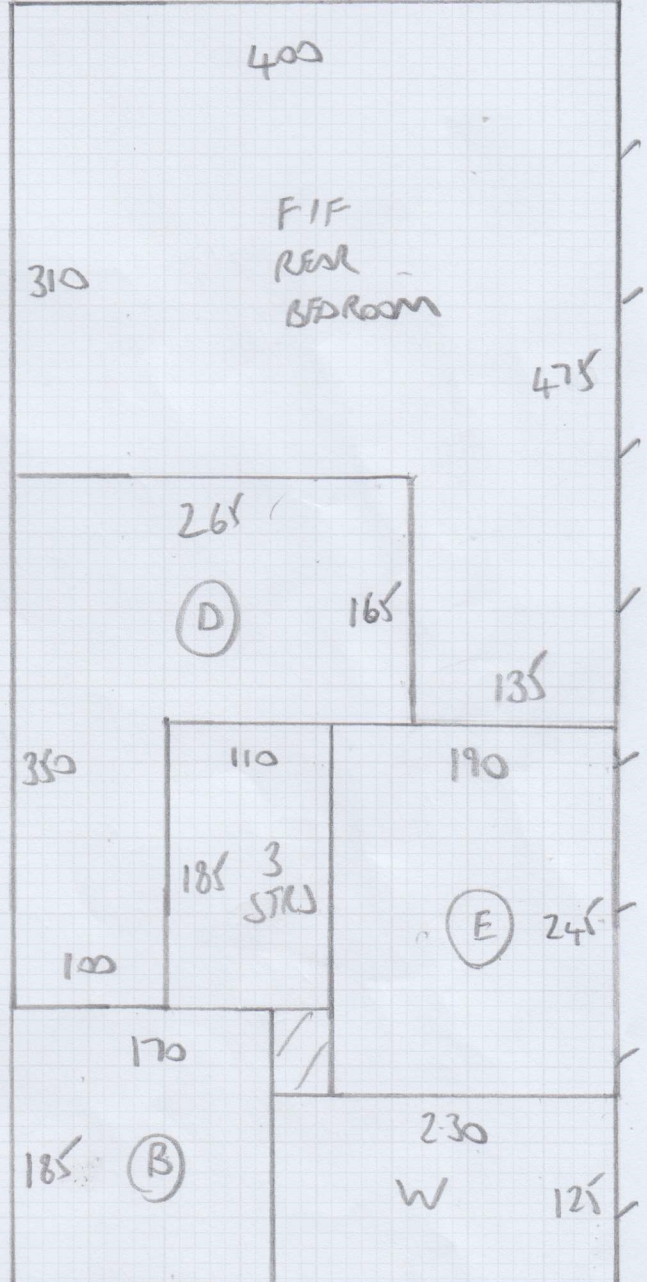
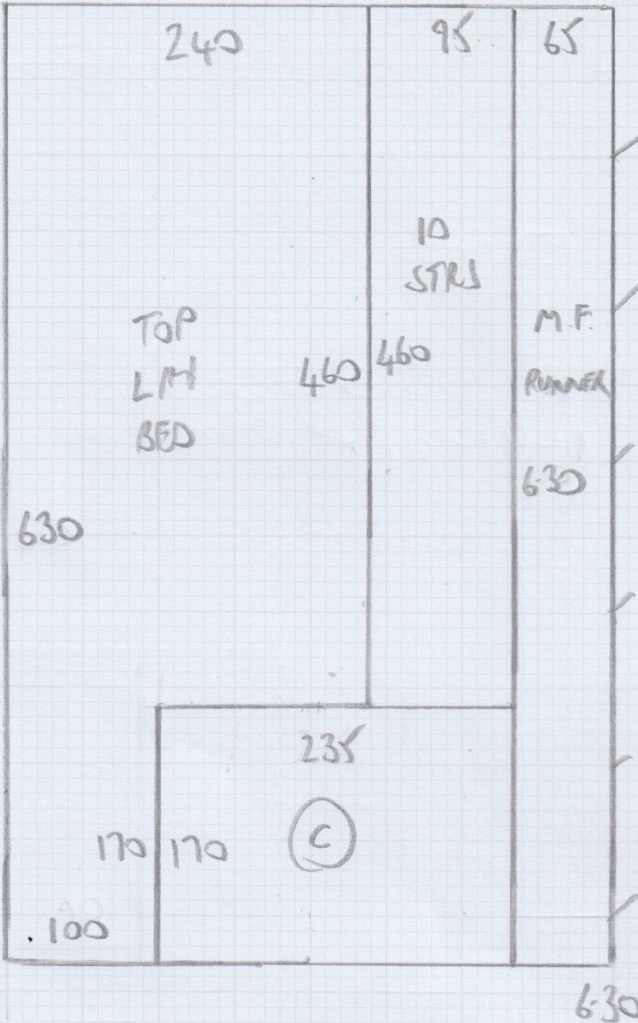

5.70 - MB
 6.30 } CIP
 6.20 }
 8.45 }

 26.65m x 4.00m = 106.6m²