

Job No: F29362
 Name: HORNE
 Address: 14 EATON TERRACE
 SW1W 8EZ

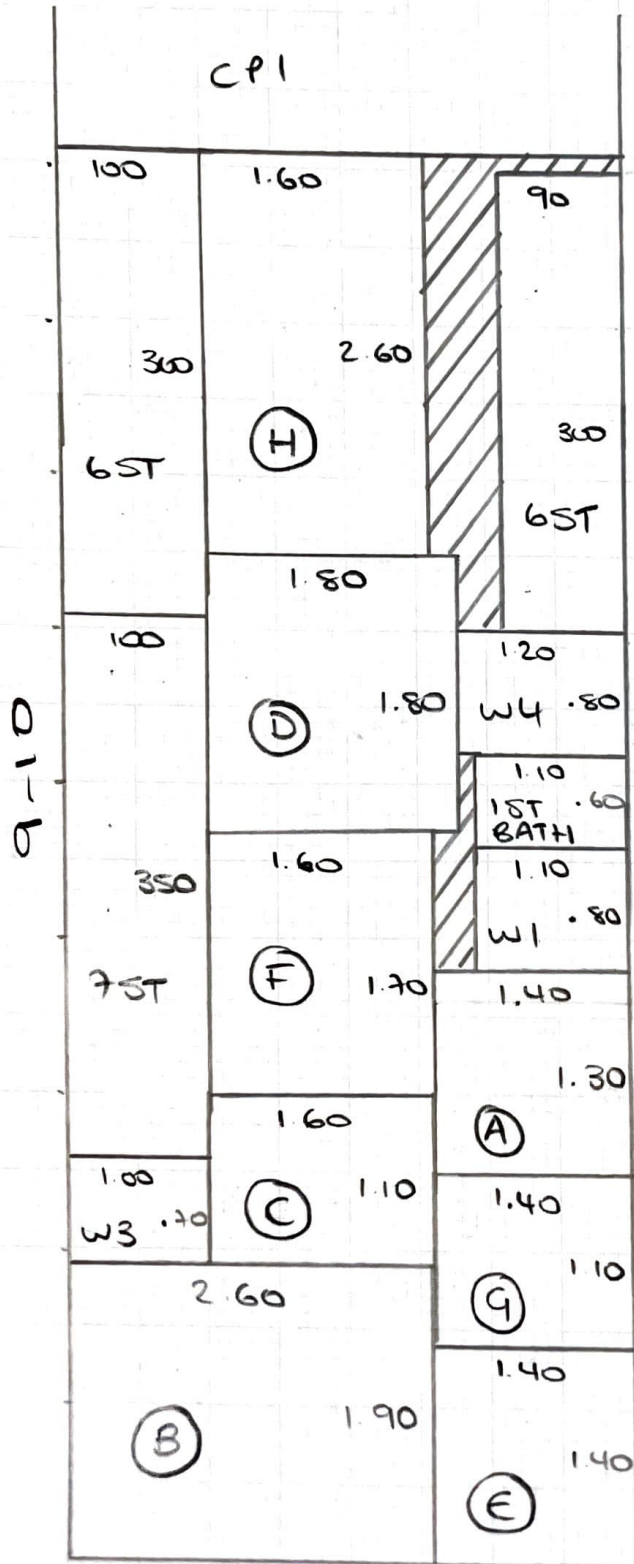

NEW ENGLAND

1 OF 7

2 FLEAR - 3.70 x 4.00
 CP1 - 9.10 x 4.4
 CP2 - 4.50 x 4.00
 17.3 x 4.00 (69.2 M²)

YORK

TOP FLOOR - 4.20 x 5.00
 TOP FLOOR - 4.20 x 4.00
 BF FLOOR - 4.15 x 5.00
 BF FLOOR - 3.10 x 4.00
 2 F FLOOR - 4.15 x 5.00

13.20 x 5.00 (66.0 M²)
 5.90 x 4.00 (23.6 M²)

CP2 Biscuit

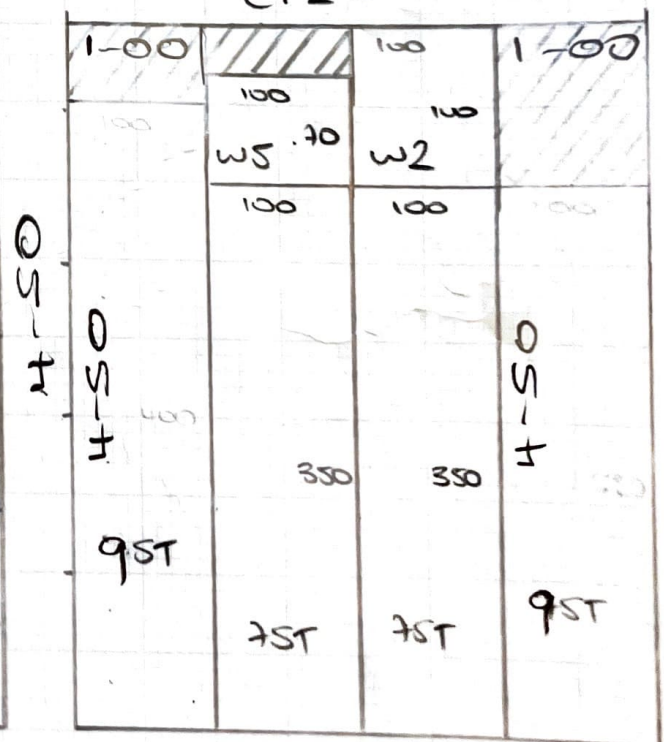

(52)

48 planned!

CP3

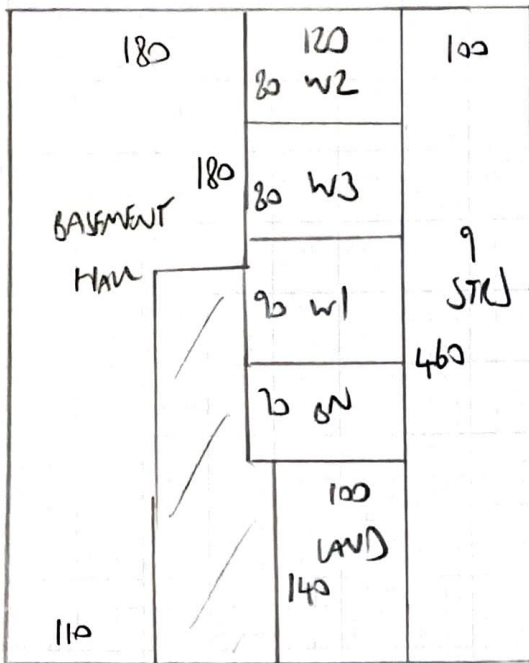

Job No: F29362
 Name: HOWE
 Address: 14 EATON TERRACE
 SWIL 8E2
 Tel:
 Sheet: 2 OF 7

4.60 x 4.00M Bas cut Plan
 4.65 x " Basal rear
 4.80 x " " Front
 4.50 x " 2nd floor front
 " " Rear
 3.90 x " " N/S/L
 17.30 x " " N/S/L

40.00
 x
 4MTR

39.15 x 4MTR

PROVIDENCE 42.50

NE-6007

31.10 30

(21.70)

(21.70)

(21.70)

(110 to ...)

(110 to ...)

112.00 (General)

Tape CK99

BASEMENT

WT 84x93

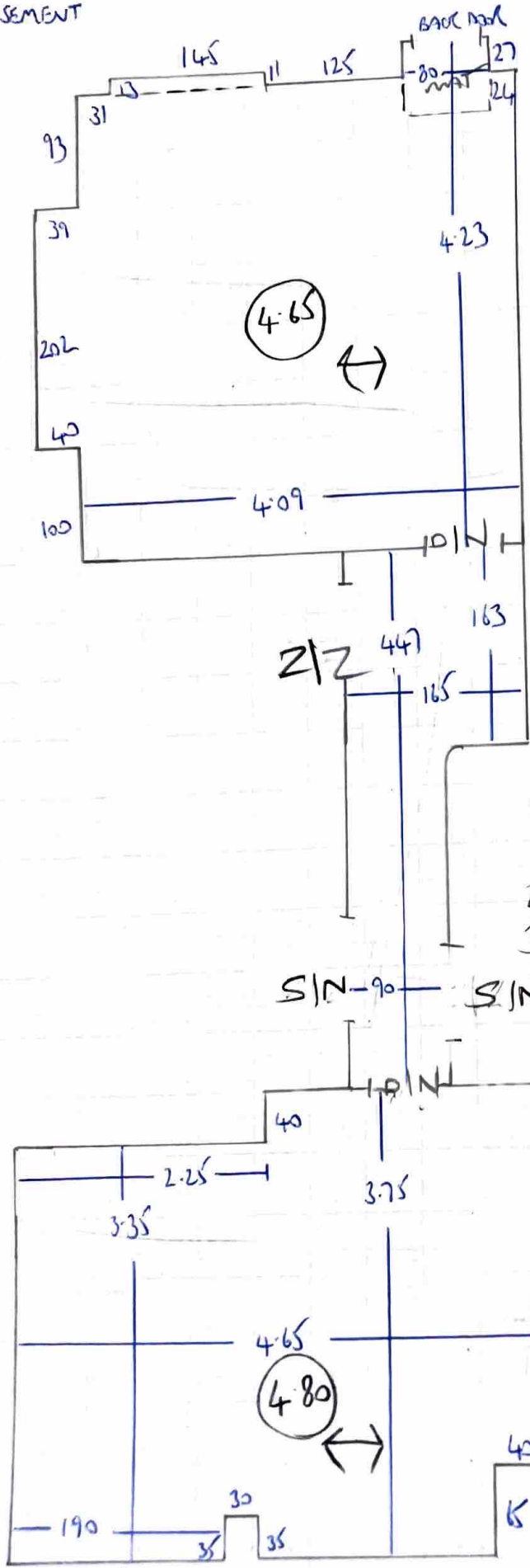

~~F29362~~ F29362
 HORNE
 14 EATON TERRACE
 SWIW 8E2

3 of

SKIRTINGS 2cm OFF
 FLOOR - DAMP PROOFING
 FIT UNDER SKIRTINGS

8N 90x50
 9 STMS 74
 1 W 73x75
 2 W 105x67
 3 W 87x62

60CM

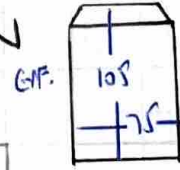

CLOSE COVERED

Job No: F29243 F29362

Name: HORNE

Address: 14 ETON TERRACE
SW1W 8EZ

Tel:

Sheet: 4 of 7

FIRST FLOOR

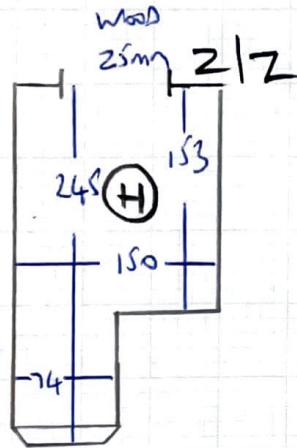

4 STMS 74

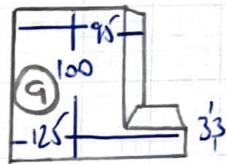

W310x59
W405x66
W575x62

8 STMS 74
GIF

- RUN
60cm

Job No: F29243 F29362

Name: HARVE

Address: 14 EASTON TERRACE
SW1W 8E2

Sheet: BOF 7

THIRD FLOOR

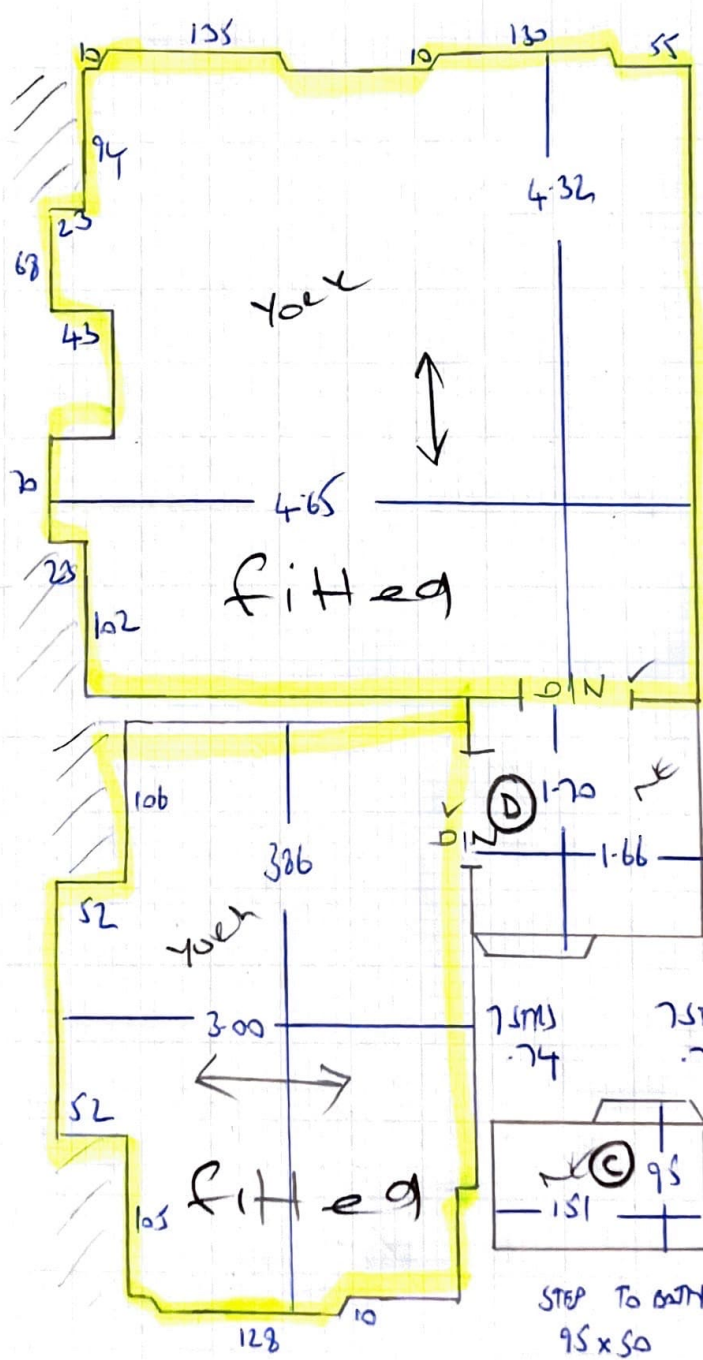

YOUK
 YOUK
 YOUK
 YOUK
 YOUK
 (BATH 16mm TRG)

3.00 UNIT

YOUK
 YOUK

Job No. F22243 F 29362

Name: HOWE

Address: 14 EATON TERRACE
SWIW 8E2

TOP FLOOR

70A7

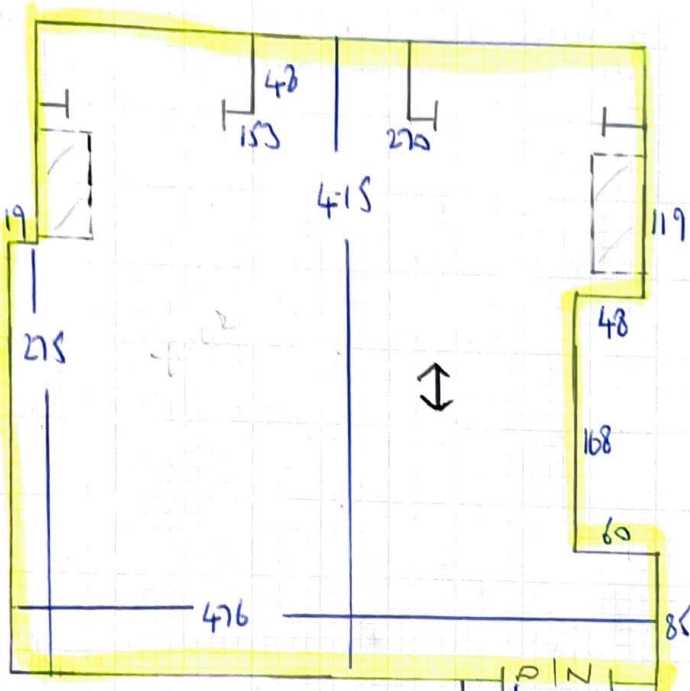

4 1/2" x 11" R.V.
YORK VELVET
YORK 226

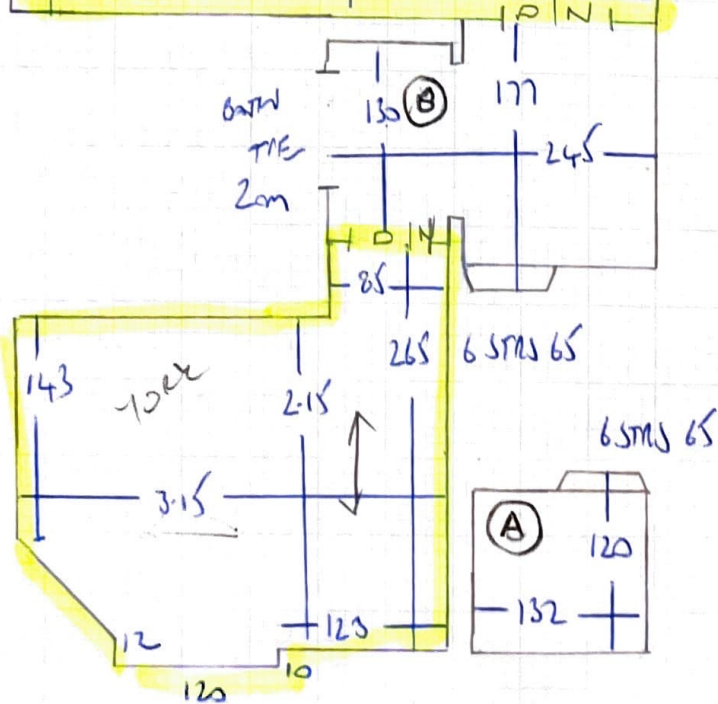

3 000 x 4 M IN
YORK VELVET
YORK 226