

①

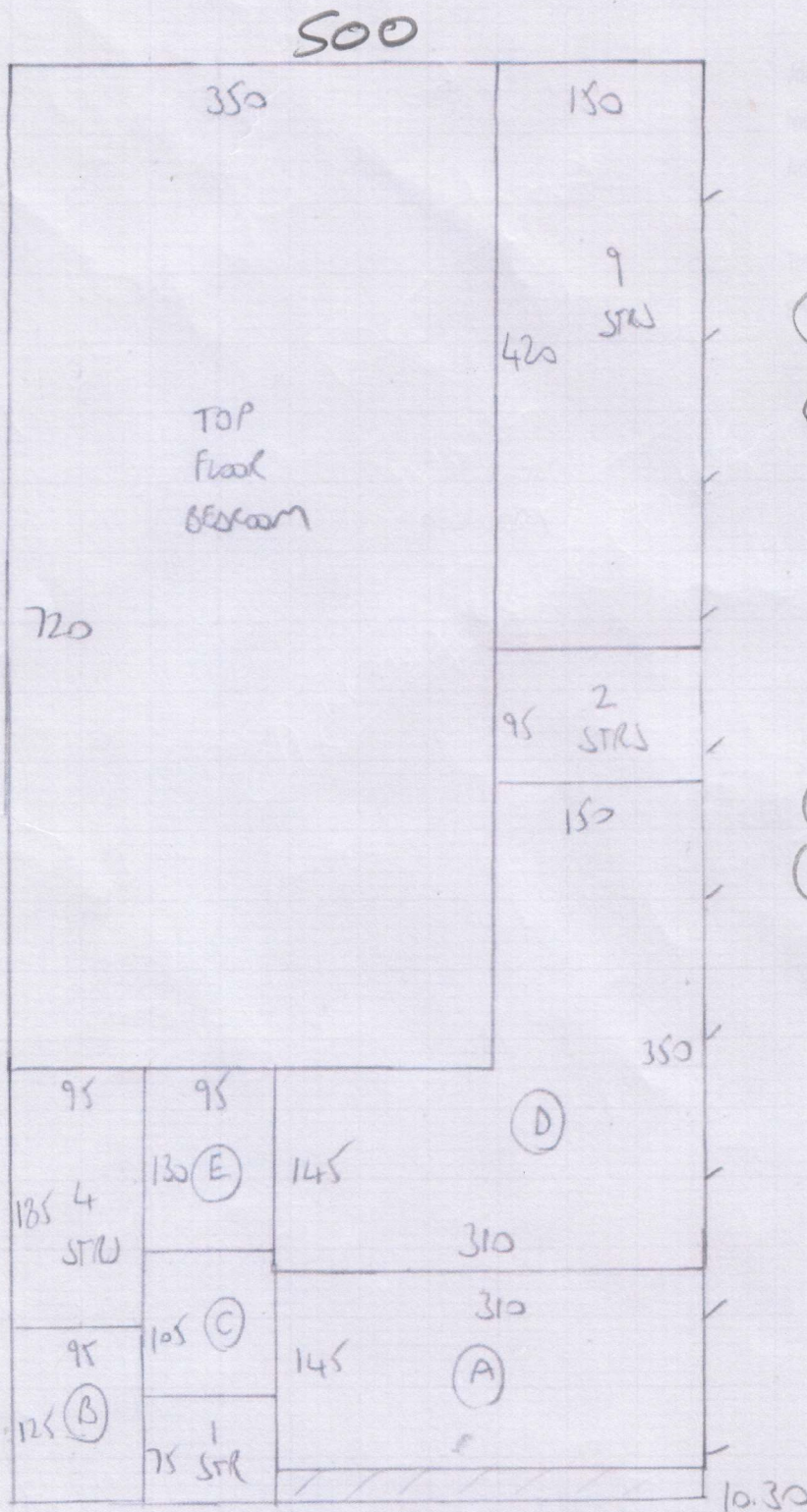

F30825

ADD  
31 FLOOR ST  
SW6 SAE

1 of 4

~~1030 x 500~~

① 1030 x 500

② 285 x 500

③ 315 x 500

④ 330 x 500

MAIN 465 x 500  
BED

~~1030 x 500~~  
~~285 x 500~~  
41.20 x 500 = 1603

2

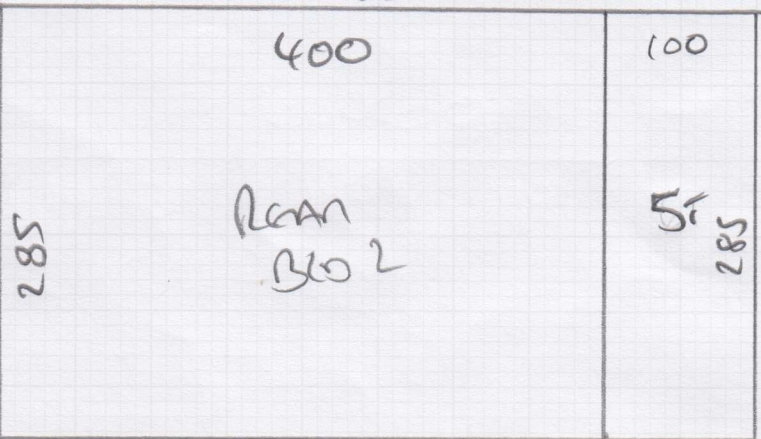

3

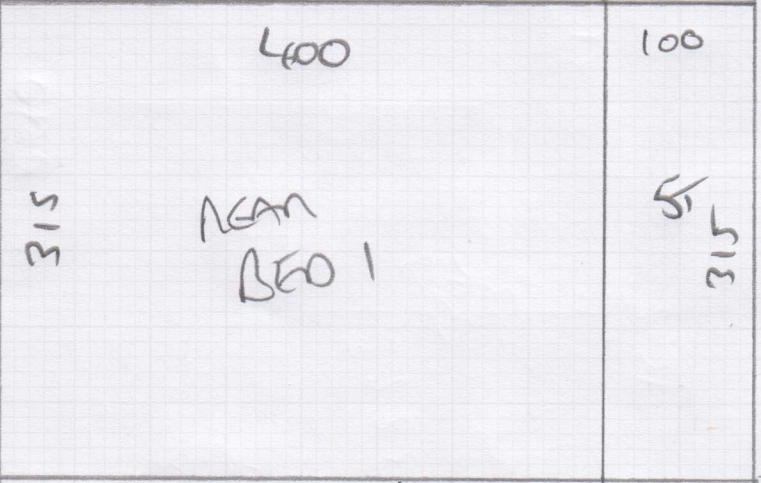

4

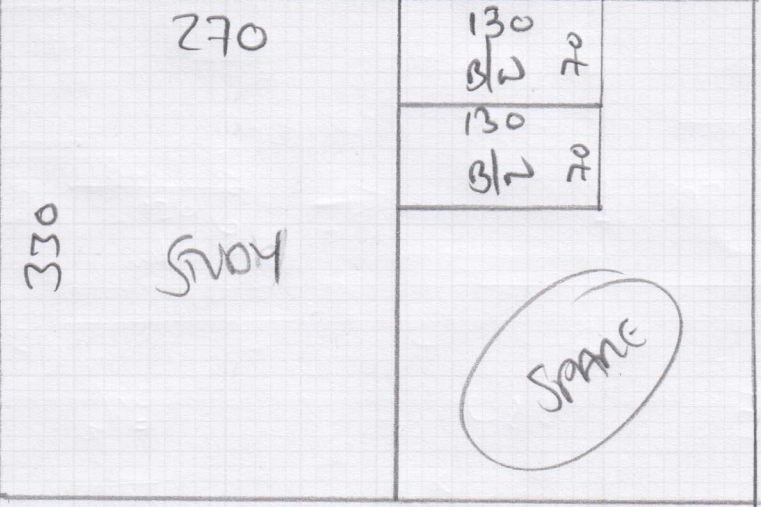

mrcarpets  
DESIGNS FOR FLOORS

Job No:

F30525

Name:

ADDA

Address:

20PK

Tel:

Sheet:

of:

F30525

~~ASWB~~

ADDA

31 FEUDEN ST

SW6 SAE

TOP FLOOR

~~ASWB~~ (3064)

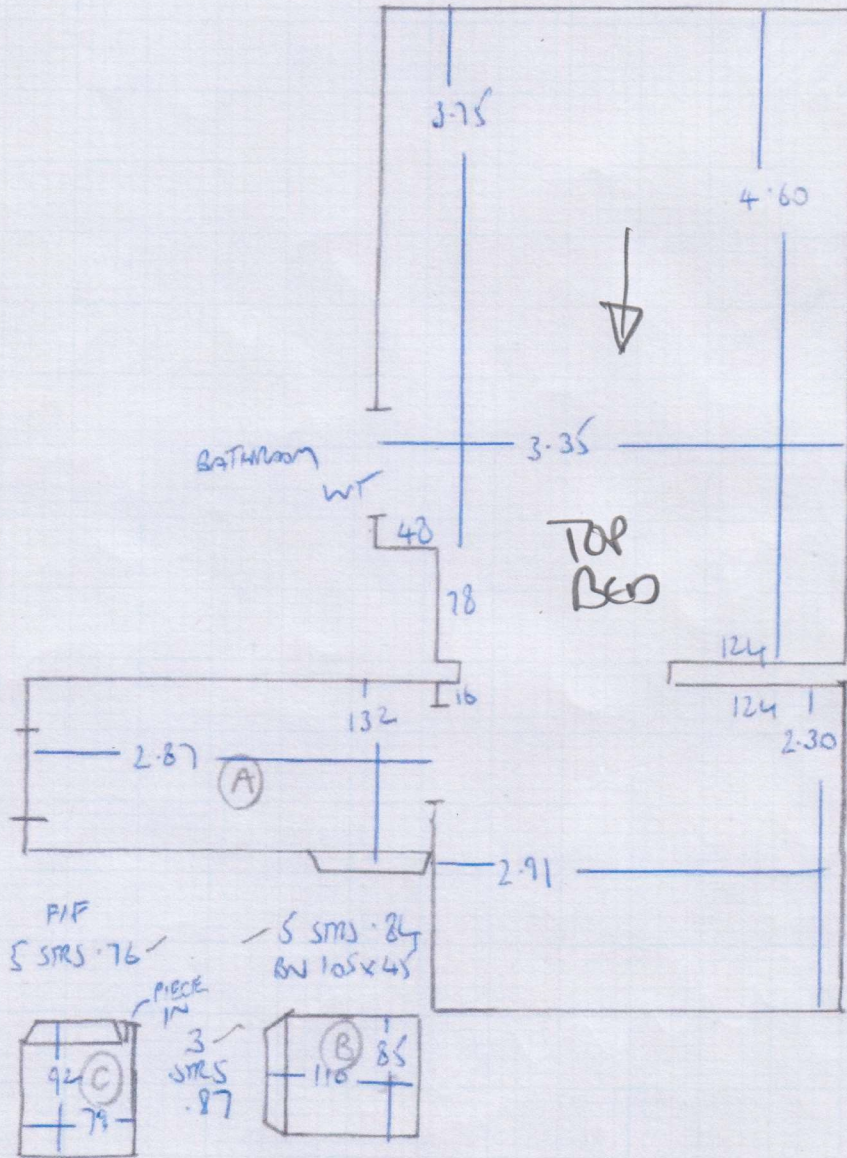



Job No: F30525  
 Name: ADDA  
 Address:  
 Tel: **10FF**  
 Sheet: 01

BROOKLYN

- BRU-WOG

① = 1030 x 500

② = 285 x 500

③ = 315 x 500

④ = 330 x 500

MAIN = 465 x 500  
 BGO

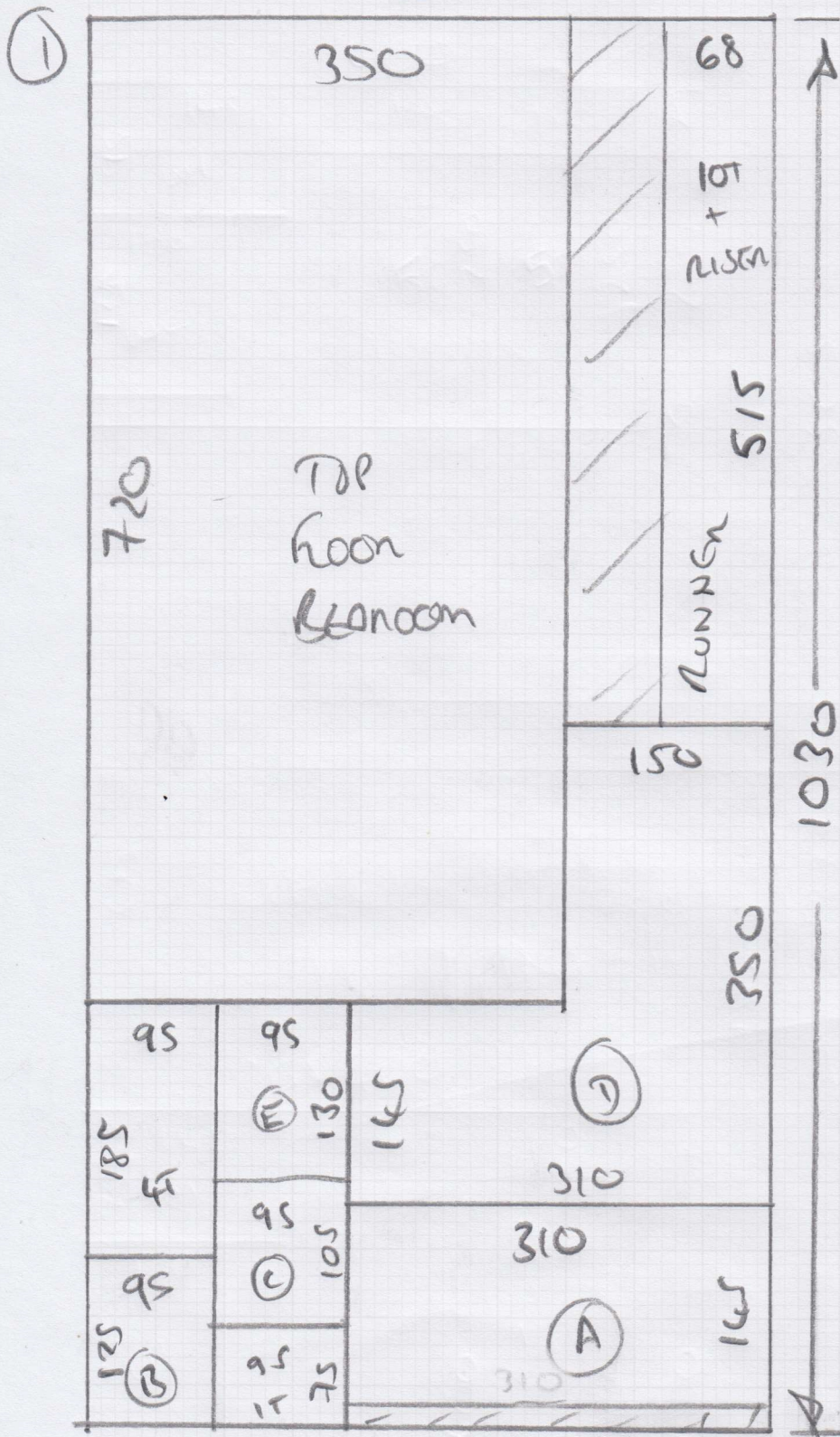

Job No: F30525

Name: ADPA

Address:

Tel:

Sheet:

20PK

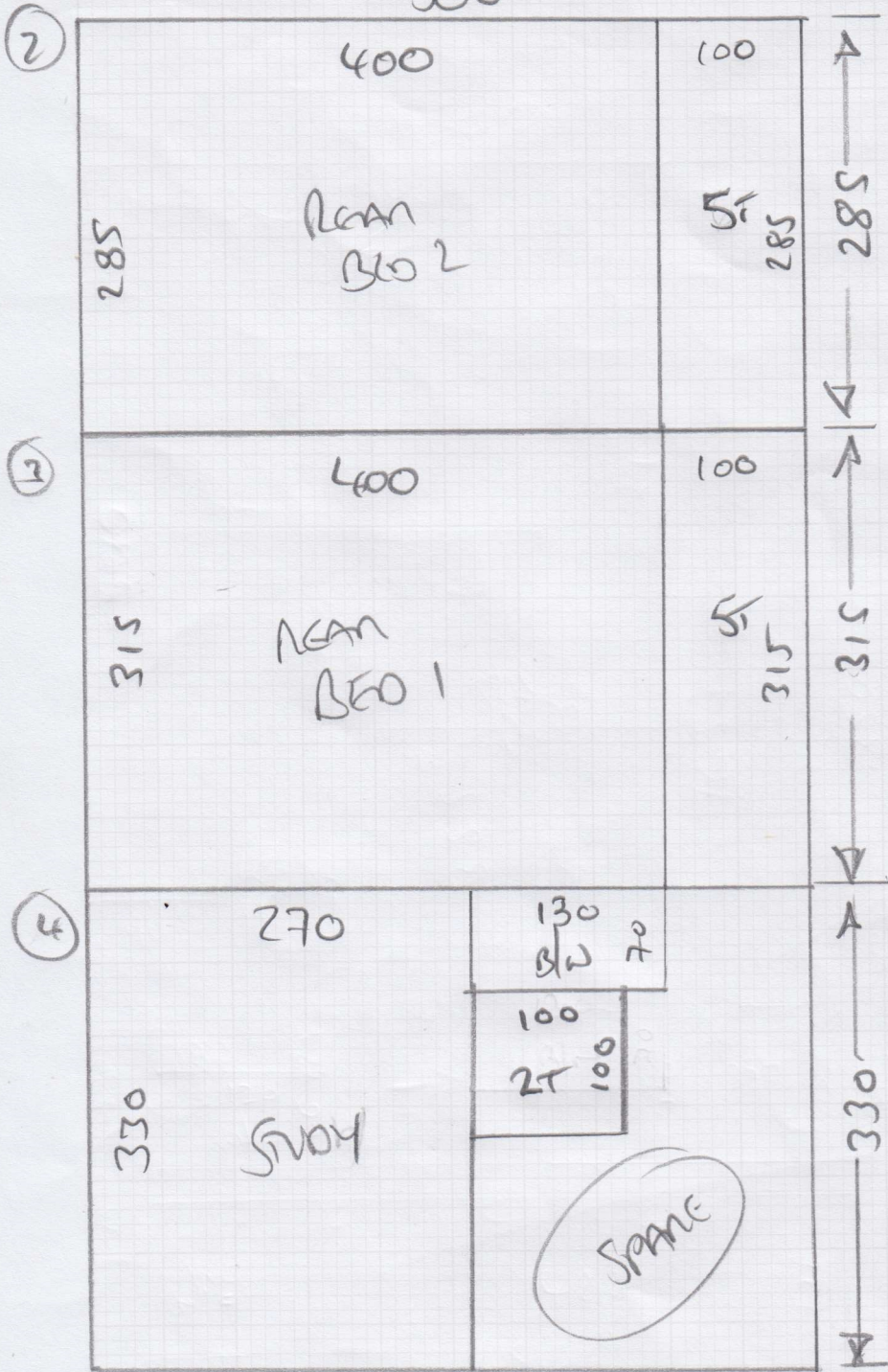

F30525

~~ADD~~

ADDA

31 FEUDEN ST

SWO SAE

TOP Floor

~~ADD~~ 30r4

