

mrcarpets
 Job No: P26413
 Name: Chartridge
 Address: Plot 1, 11 Galley Lane
 Tel: 1079
 Sheet: 1

Appleby 50
Col. AP50/OIN

- Leisure Room 890x500
 - Bed 6 370x500
 - Bed 2 455x500
 - Dining Room 395x500
 - Cut Plan ① 940x500
 - " " ② 1300x500
 - " " ③ 1305x500
 - " " ④ 970x500
- 6625 x 500
 = 331.25m²

Whipping = 28.40 Lm

STAIRRODS = 30 @ 80cm

* Cut Runners & Send for Whipping ASAP

30m	28.5	8.75
Roll A	Roll B	Roll C
1300	890	455
1305	940	395
370	970	<u>850</u>
<u>29.75</u>	<u>28.00</u>	

③

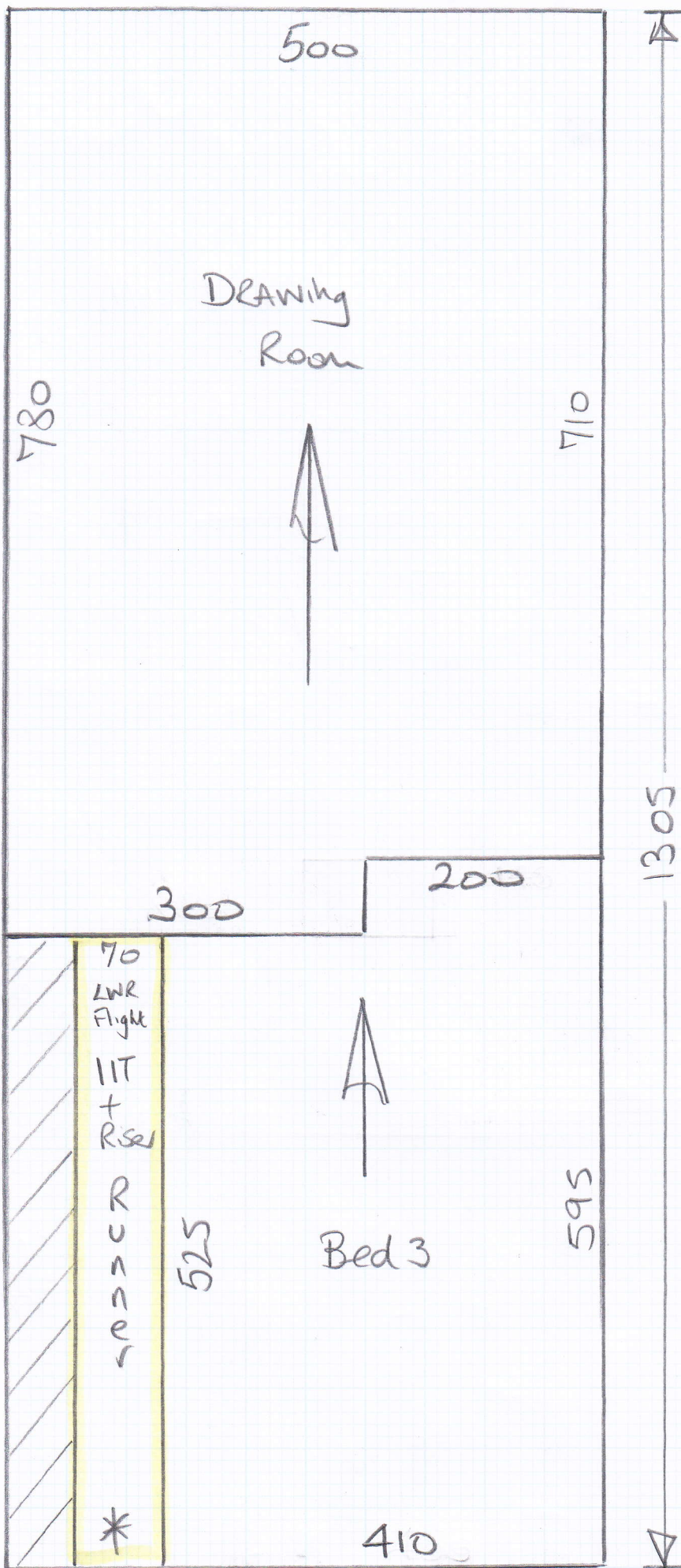

Job No: P26413
Name: Chartridge

Address:

Tel:

Sheet:

2 of 9

②

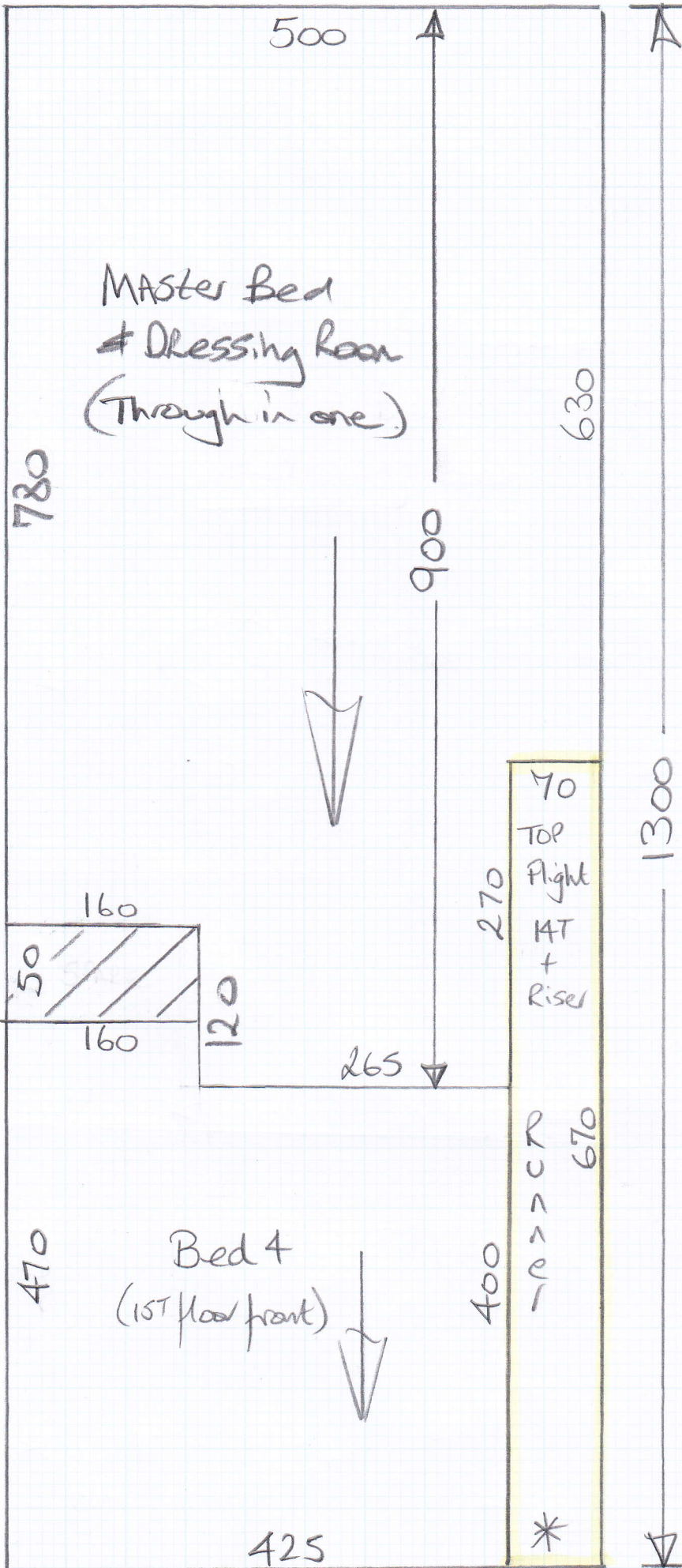

mrcarpet

Job No: P26413

Name: Chartridge

Address:

Tel:

Sheet: 3 of 9

④

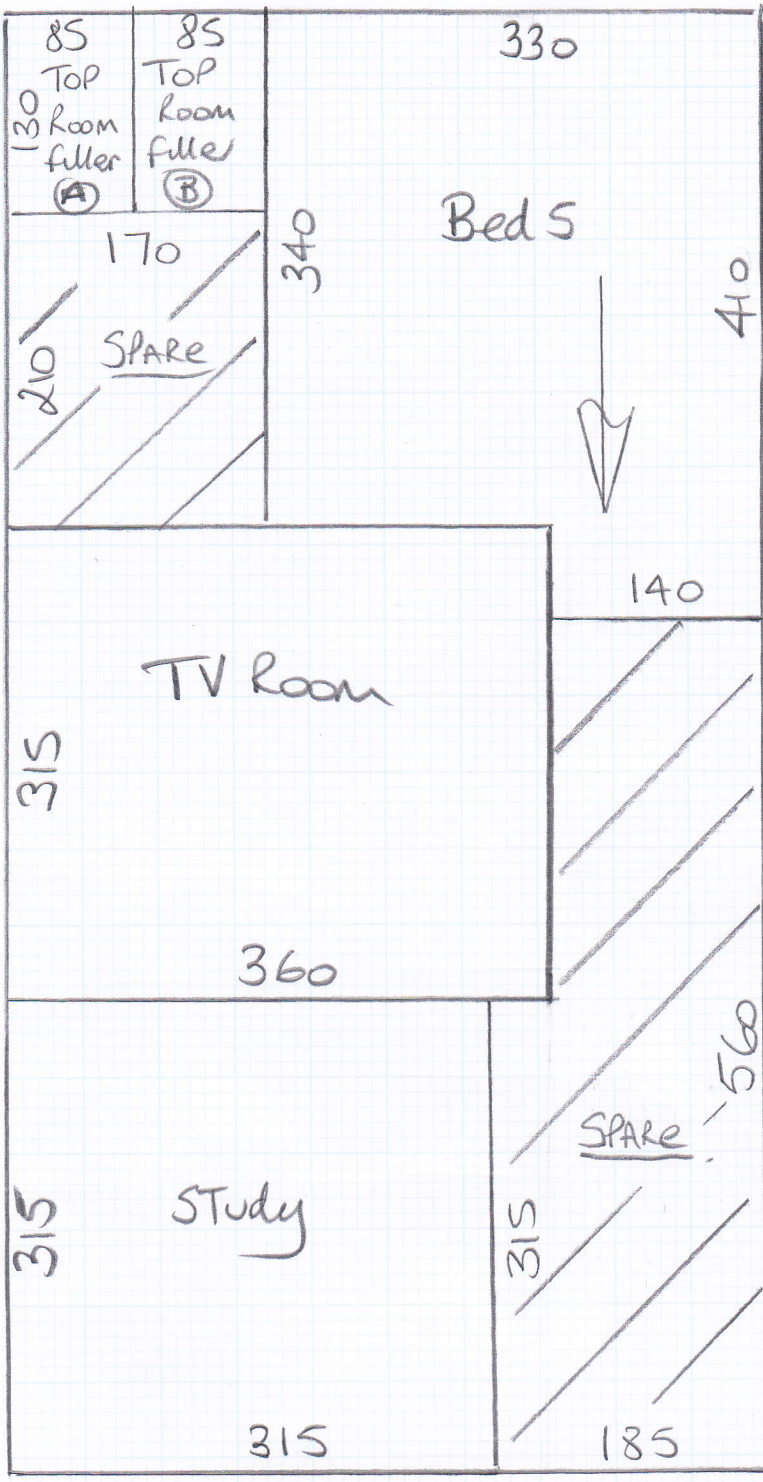

mr carpet
Job No: P26413
Name: Chantridge
Address:
Tel:
Sheet: 4 of 9

Cut Mats from Spare Carpet & position around the house at strategic places to protect carpet from getting dirty.

floor needs repair

mr carpet

P26413
Chartridge

Job No:

Name:

Address:

Tel:

Sheet:

7 of 9

1st floor

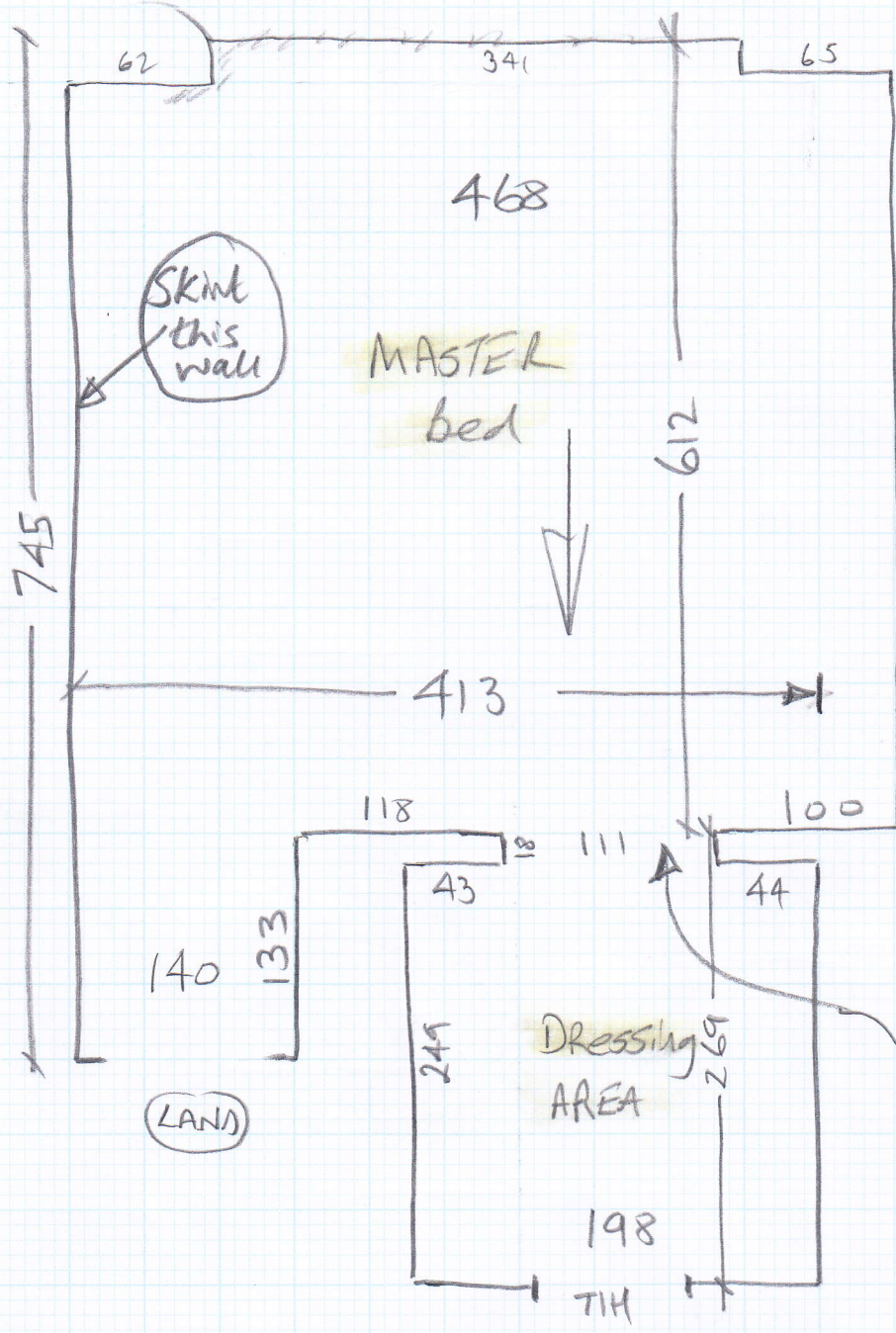

880 o/a

Through in one

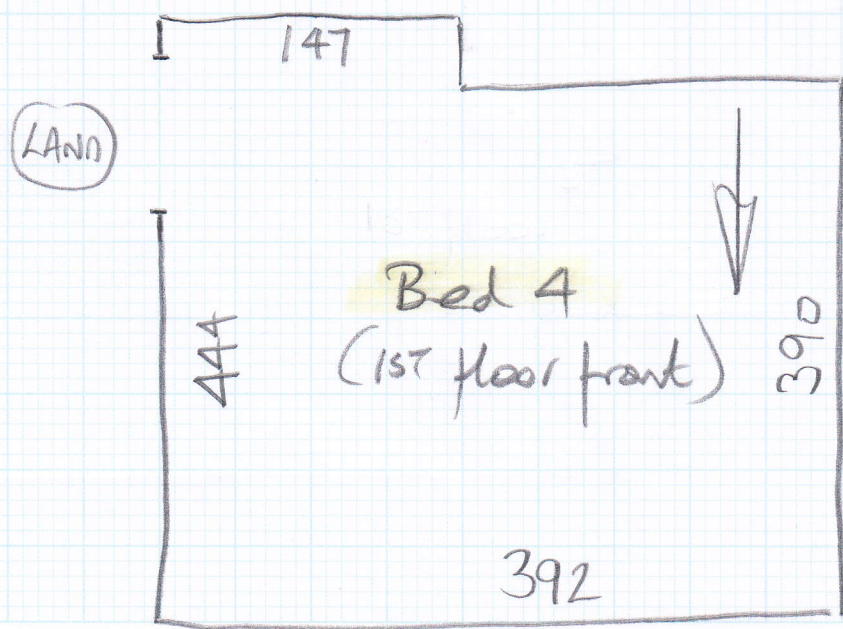

Job No: P26413
Name: Chanbridge
Address:

Tel:
Sheet:

8 of 9

Grand floor

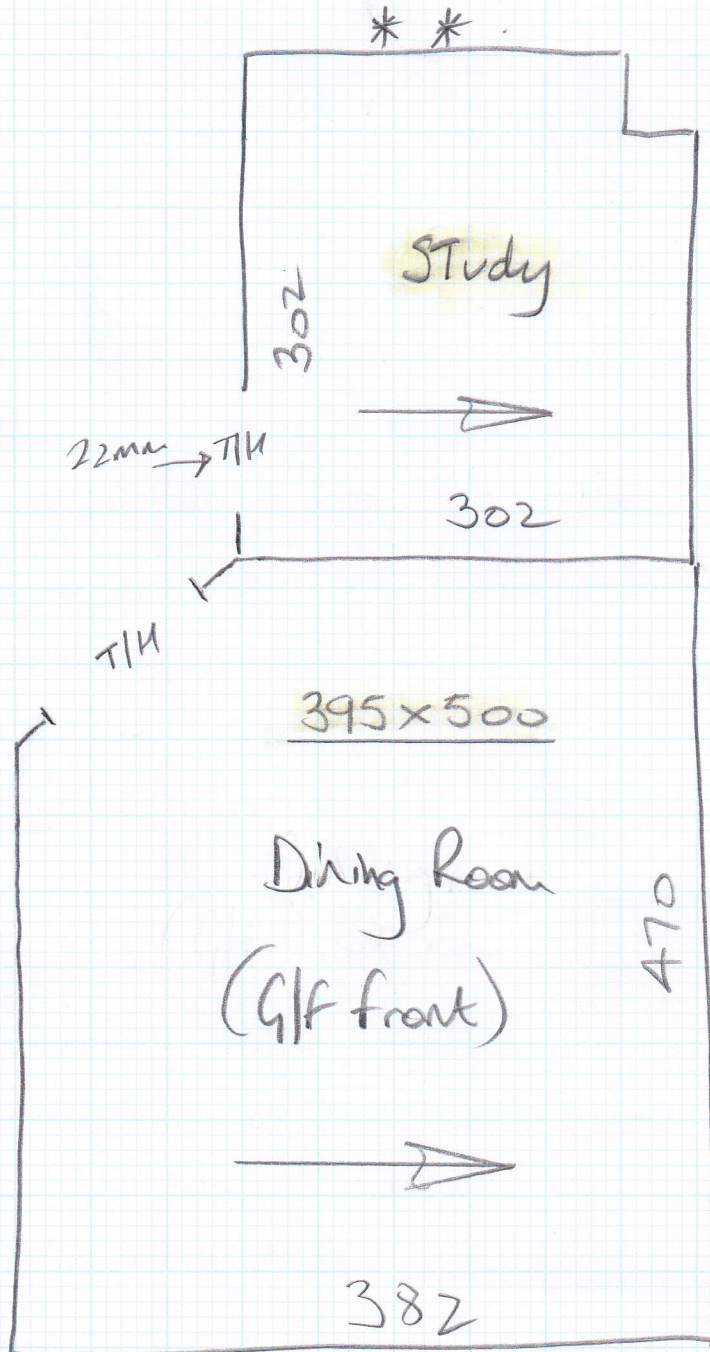

Concrete floors

Floor
Needs
Repair

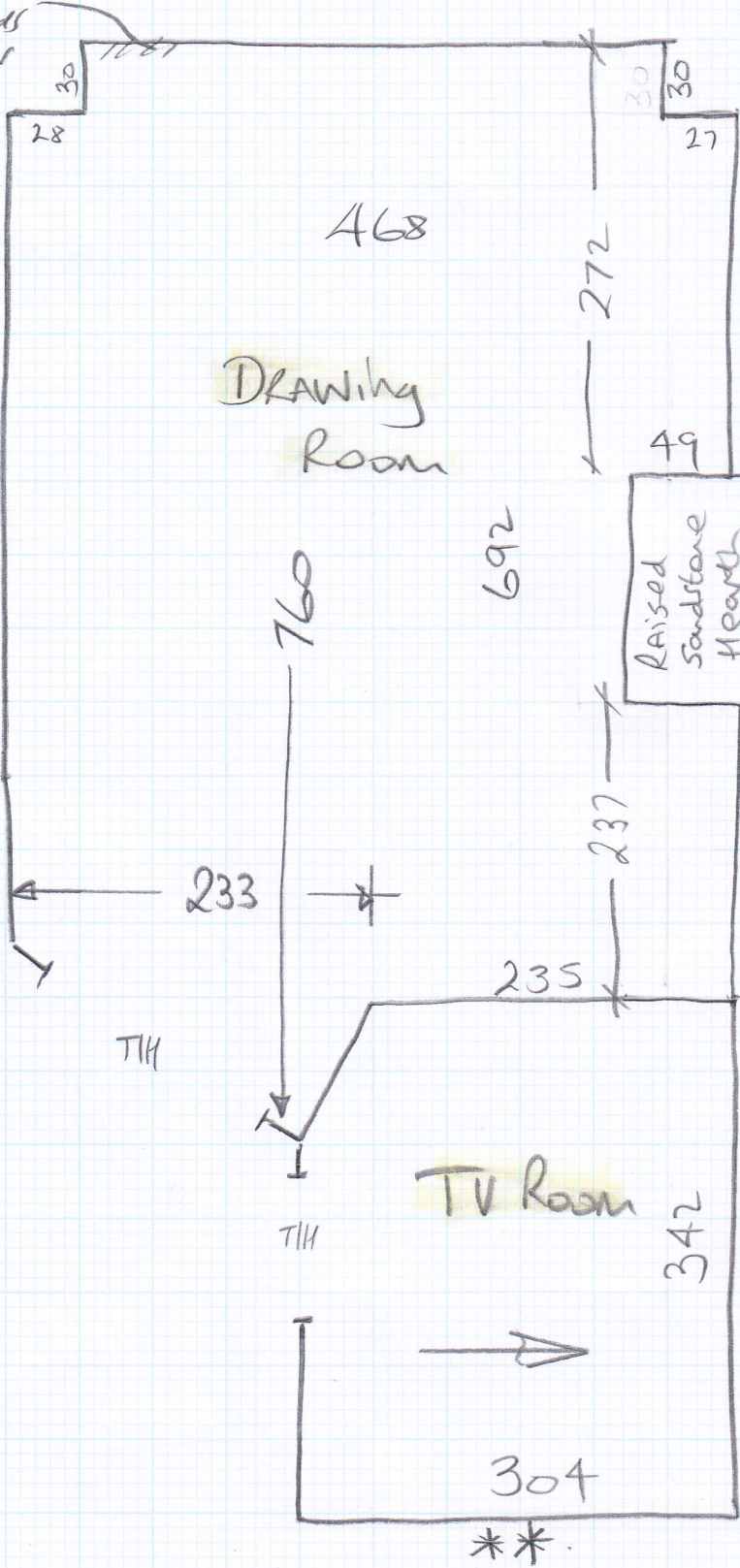

mrcarpets

P26413

Job No:

Chartridge Dev.

Name:

Address:

9 of 9

Tel:

Sheet:

Grand floor

Concrete
floors.

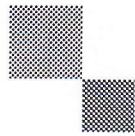

mrcarpet
DESIGNS FOR FLOORS

70 Lower Richmond Road
Putney
SW15 1LL

Tel Nr: 020-8789 3133
Fax Nr: 020-8780 2140

ROLL BREAKDOWN

Job No: P26413

Customer Name: Chartridge Developments

Carpet: Appleby 50

Colour: AP50-01N

All rolls are 5m wide Rolls

Roll A	Roll B	Roll C
30.00	28.50	8.75
13.00*	8.90	4.55
13.05	9.40	3.95*
3.70	9.70*	
0.25	0.50	0.25

*** Cut these pieces last on each roll & leave the roll balances on them**

* Lynne,
I need these back by
Wed Morning 1st thing
if possible Thanks, Nigel

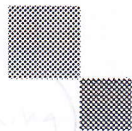

mrcarpet
DESIGNS FOR FLOORS

70 Lower Richmond Road
Putney
SW15 1LL
T 020-8789-3133
F 020-8780-2140

BH CARPETS - WHIPPING / BINDING FORM

Tel - 020-8665-9110 email: bhcarpets@gmail.com Fax 020-8665-6611

Customer Name:

Chartridge Developments

Job No.:

P26413

Description of carpet:

Appleby 50 - AP50-01N

Whipping / Blind Binding / Top Taping

All Round / Sides only (for Stair Runner)

Colour of Binding tape: _____ Size of Binding tape: _____

Amount showing on top _____ Colour of Whipping: To Match

Number of pieces: 3

Ready to collect on: 15 / 6 / 15 Needed back by: 17 / 6 / 15 (1st thing)

Sizes to be cut to: 2.25, 670, 525 x 70cm

Whipping: 2840 metres @ £2.00 linear metre £ 5680

Apply Tape: _____ metres @ £6.00 linear metre £ _____
(Supplied by MRC)

Blind Taping: _____ metres @ £7.00 linear metre £ _____
(including. Tape)

Trimming Charge (if applicable) £ _____

ANY QUERIES CALL:

Nigel Canice Jack

Total £ 5680

Collect from:

Warehouse / Putney Shop

Deliver Back to:

Warehouse / Putney Shop

Mr Carpet Use. (Copy to be faxed to Shop & accounts Dept. when returned)

Date Collected: _____ Collected By: _____

Date Returned: _____ Returned By: _____

Invoice No: _____ Comments: _____