

\* 6H

MUST CUT RUNNERS FOR LOWER STAIRS & SEND TO BH ASAP SO THEY ARE BACK & READY FOR FITTING ON FRI 9/9.

Job No: P27151  
 Name: Chartridge  
 Address:  
 Tel: 1 of 14  
 Sheet: or

Appleby 50 (Victoria Twist 50)  
Col. AP50-46N (Calibre)

Cut Plan ①	1500 x 500
Cut Plan ②	930 x 500
Cut Plan ③	1160 x 500
Cut Plan ④	1110 x 500
Cut Plan ⑤	320 x 500
Cut Plan ⑥	715 x 500
Cut Plan ⑦	1160 x 500
Dining Room	455 x 500
Bed T & Dressing	835 x 500
Bedroom 3	365 x 500
	<u>8550 x 500</u>
	<u>= 427.50M<sup>2</sup></u>

ORDER: - A) 30.00 x 500  
 B) 28.50 x 500  
 C) 28.50 x 500  
 87.00 x 500  
 = 435M<sup>2</sup>

①

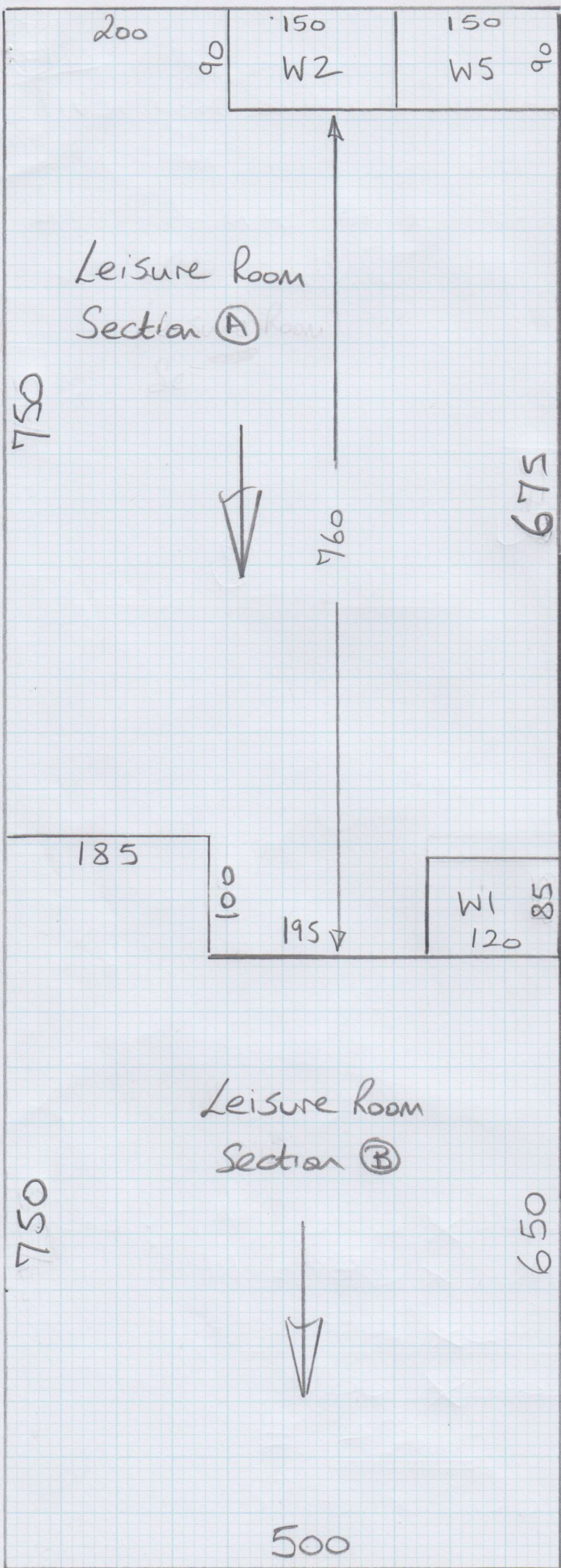

mrcarpet  
SERVICES FOR ALL

Job No: P27151  
Name: Chartridge  
Address:  
Tel:  
Sheet: 2 of 4

②

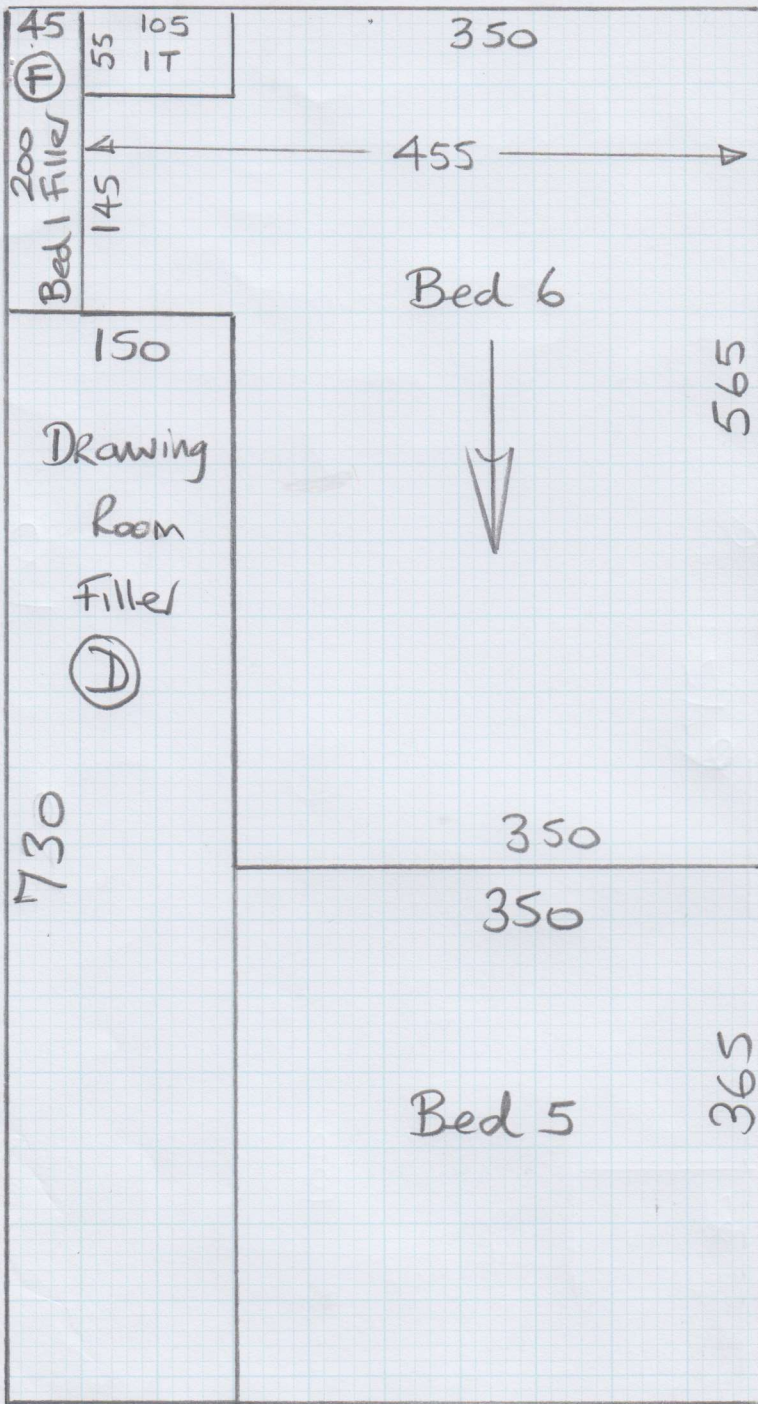

 mrcarpets  
 Job No: P27151  
 Name: Chartridge  
 Address:  
 Tel:  
 Sheet: 3 of 14

Job No: P27151  
Name: Chartridge

Address:

Tel:

Sheet:

4 of 14

3

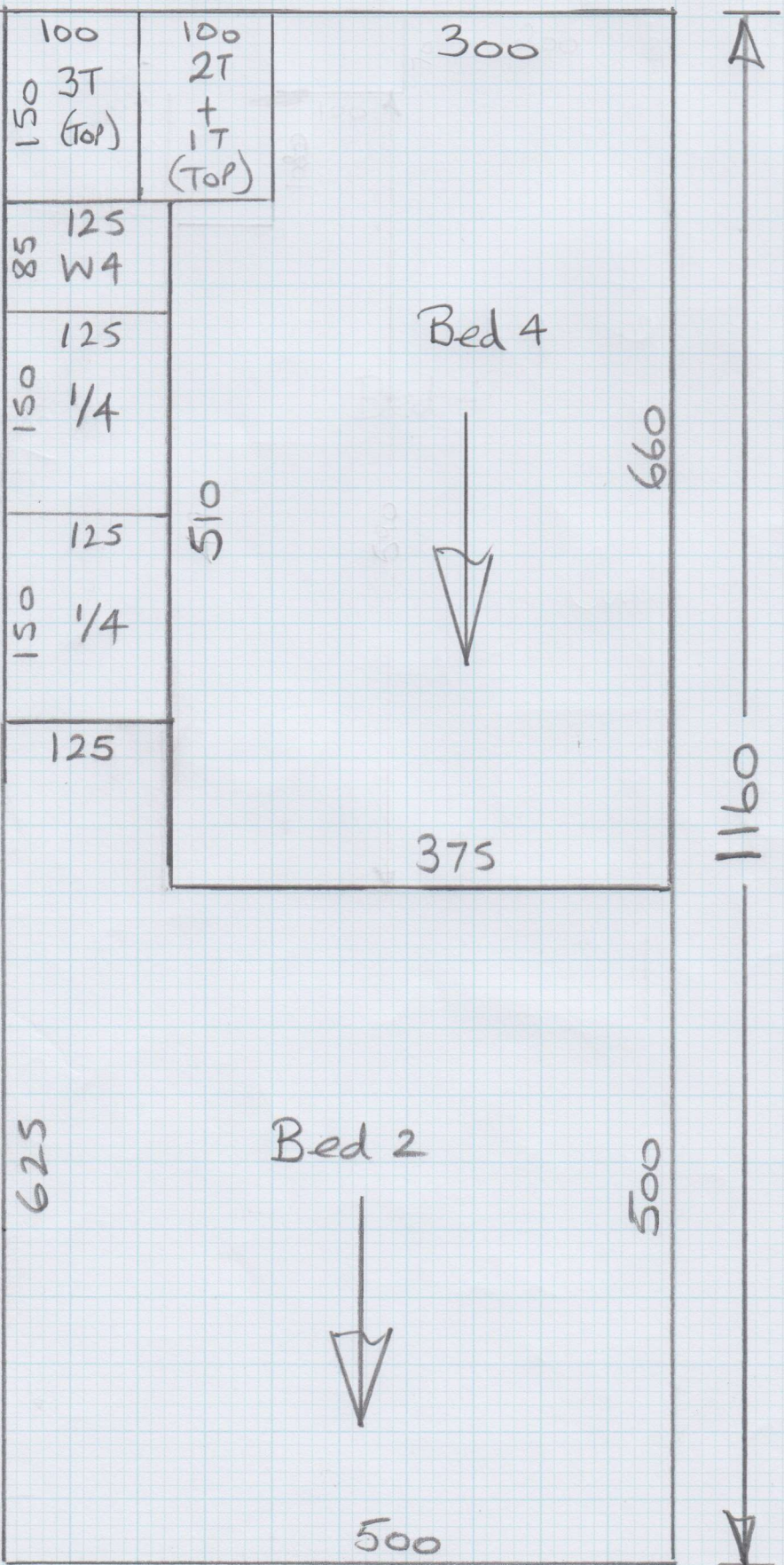

4

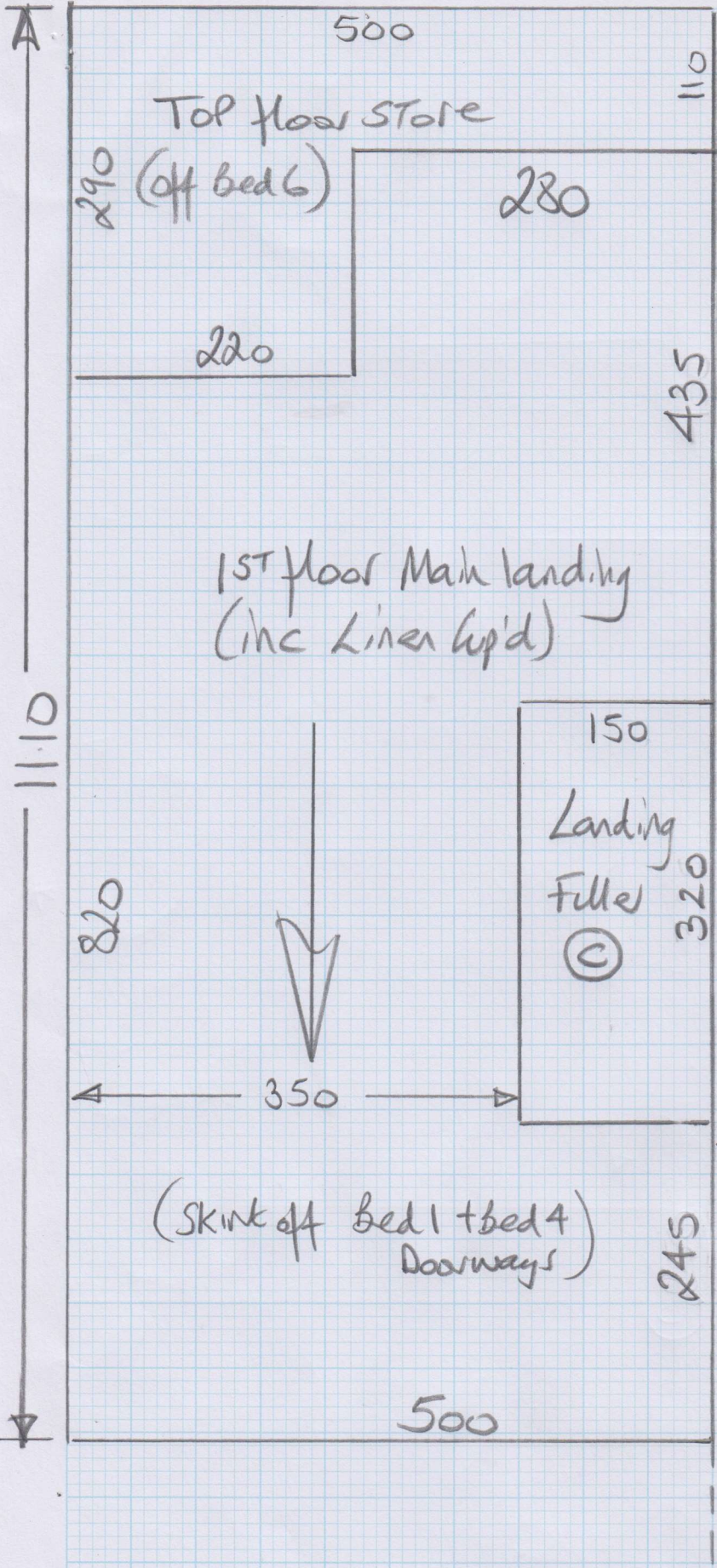

Job No: P27151  
Name: Chartridge

Address:

Tel:

Sheet: 5 of 14

5

320  
320  
715  
200

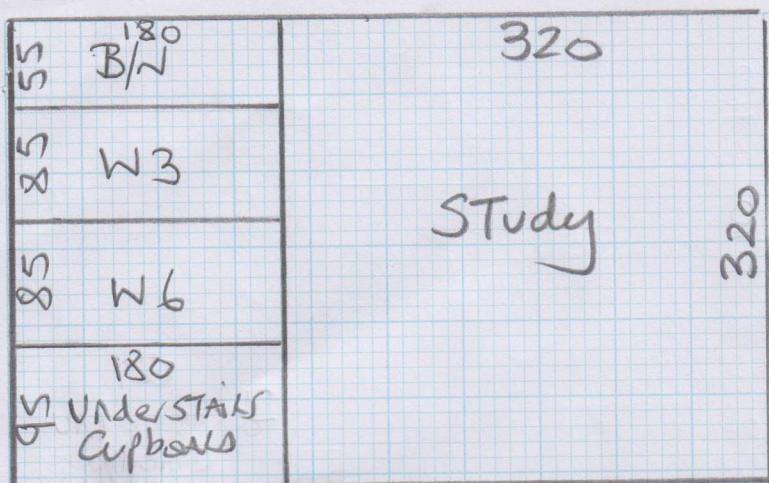

mrcarpet  
DESIGNS FOR FLOORS

Job No: P27151  
Name: Chartridge  
Address: \_\_\_\_\_  
Tel: \_\_\_\_\_  
Sheet: of: 6 of 14

6

1025  
715

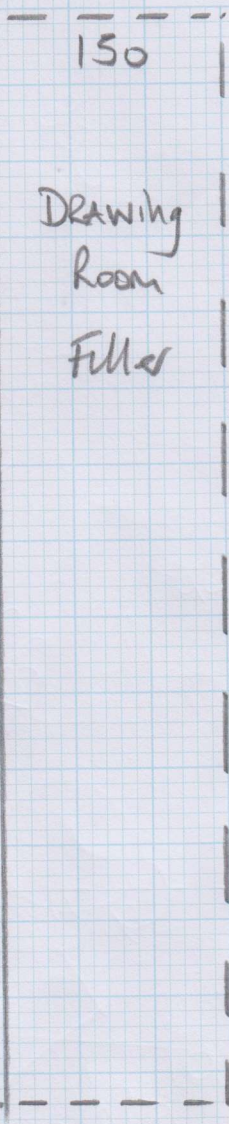
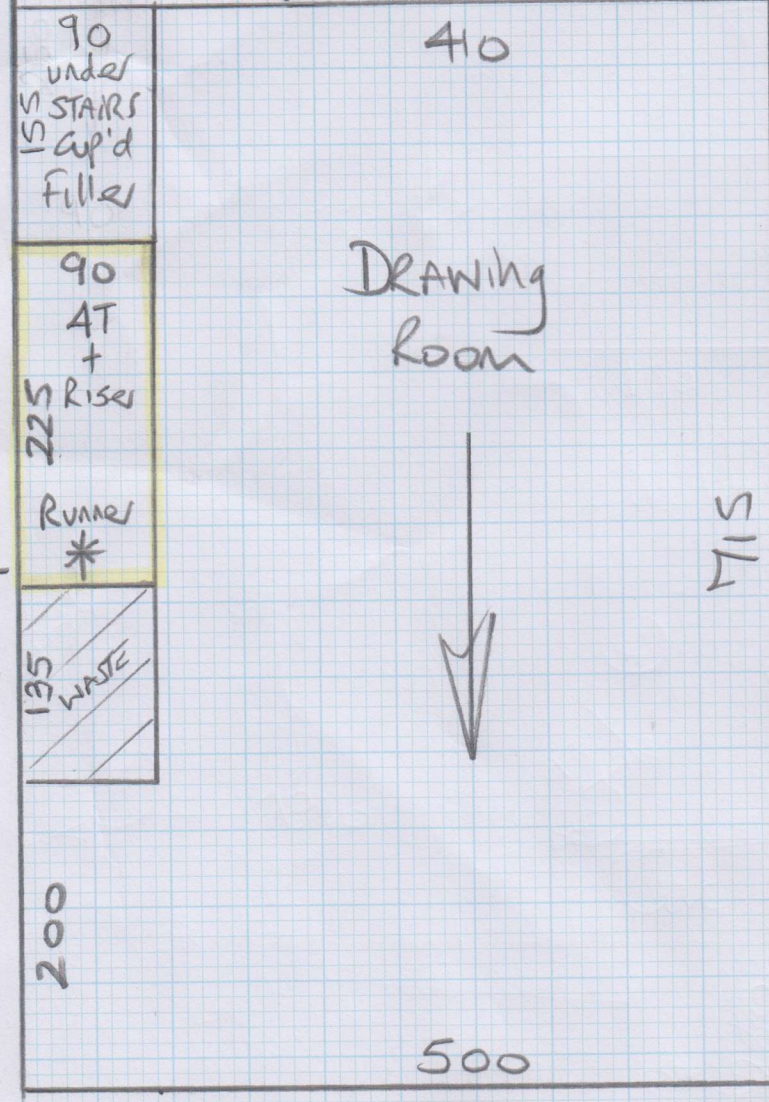

⑦

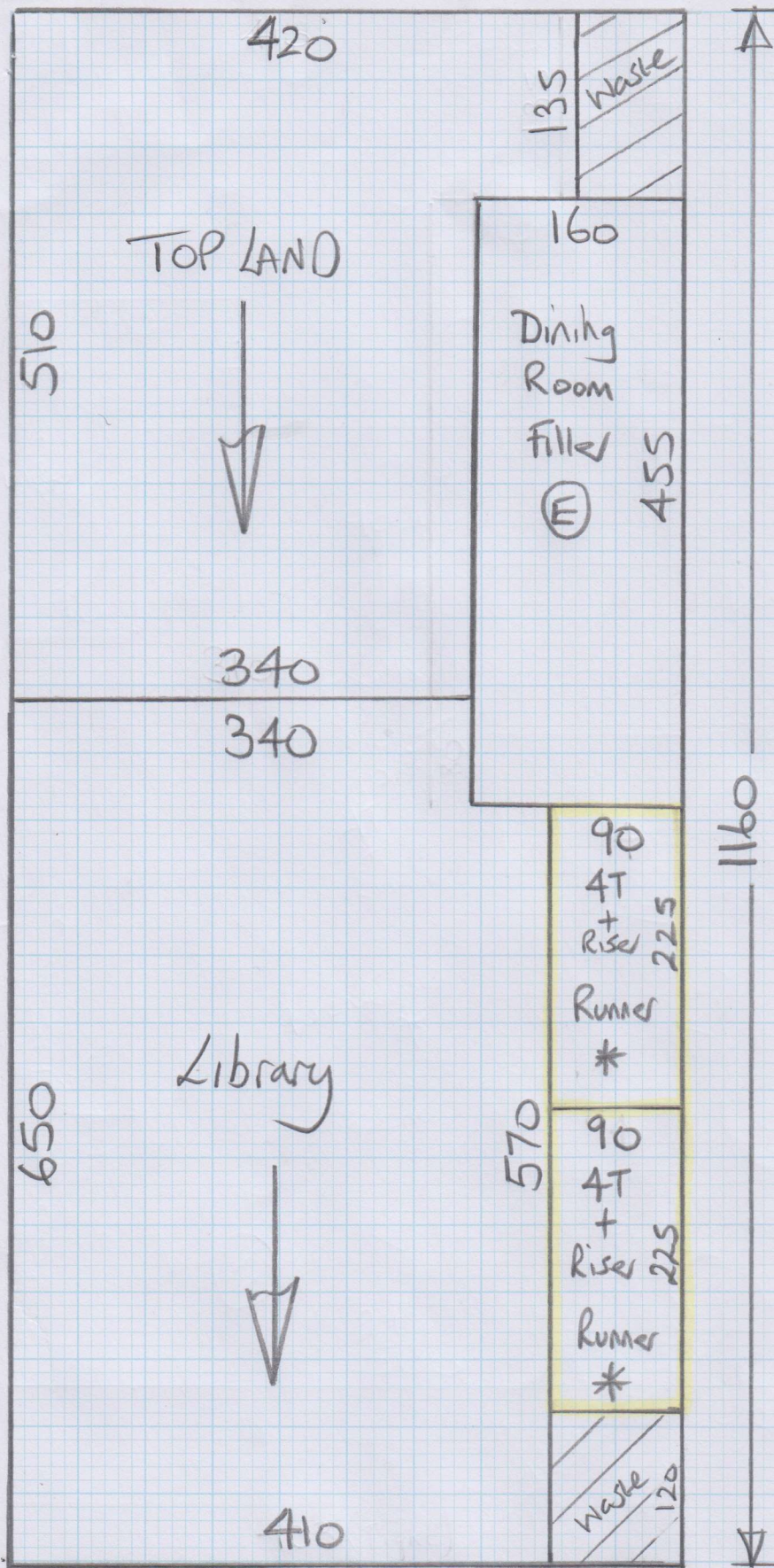

Job No: P27151  
 Name: Chartridge  
 Address: \_\_\_\_\_

Tel: \_\_\_\_\_  
 Sheet: 7 of 14

# Top floor

mrcarpet  
 Job No: P27151  
 Name: Chartridge  
 Address:  
 Tel:  
 Sheet: of

8 of 14

## TOP STAIRS

- STRS 3  $\rightarrow$  46x94
- W1 74x108
- W2 83x135
- W3 79x94
- Step 1  $\rightarrow$  46x94
- W4 73x107
- W5 82x131
- W6 79x94
- STRS 2  $\rightarrow$  46x94
- B/N 46x113

All Chipboard floors.

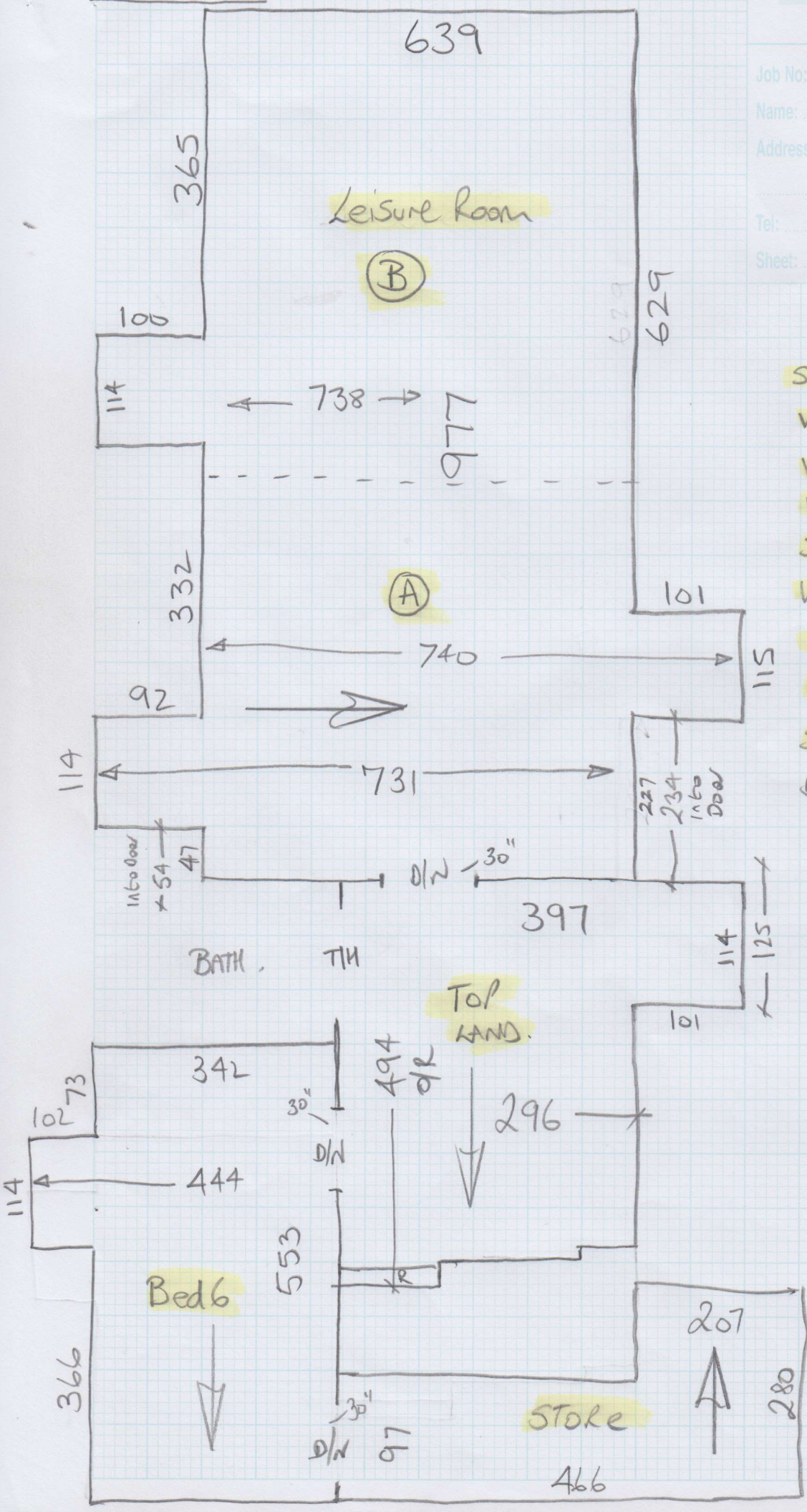

mrcarpet  
 Job No: P27151  
 Name: Charbridge  
 Address: 9 of 14  
 Tel: \_\_\_\_\_  
 of: \_\_\_\_\_

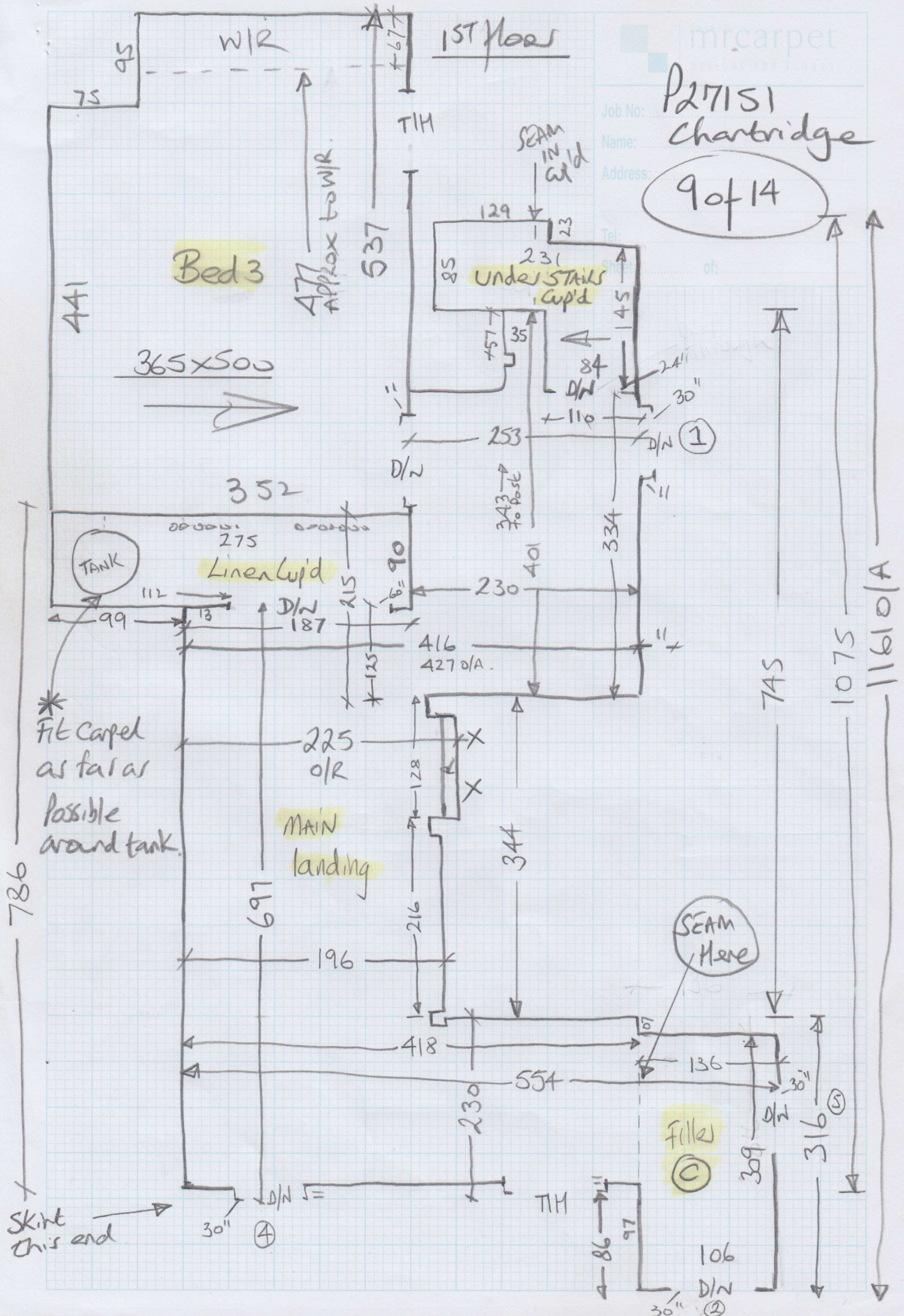

\* Fit Carpet as far as possible around tank.

SEAM HERE

Fitted ©

SKIRT this end

11610/A

1st floor

Job No: P27151  
Name: Chalbridge  
Address:  
Tel: 10 of 14  
Sheet: of:

All Concrete

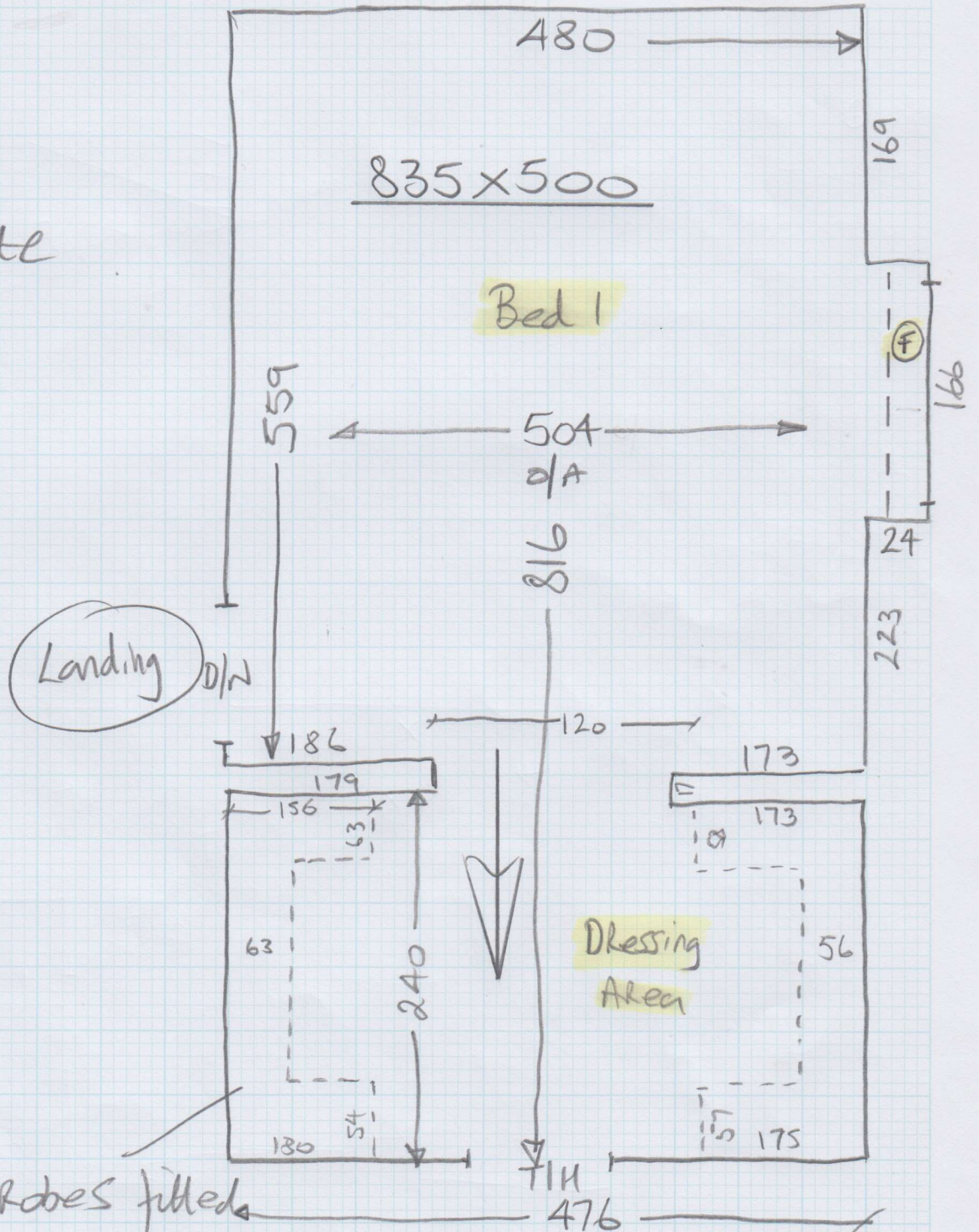

No W/Robes fitted  
Sizes are as per  
Markings on the floor  
(Approx only)

157 floor

Job No: P27151  
Name: Chartridge

Address:  
Tel: 11 of 14

Sheet: of:

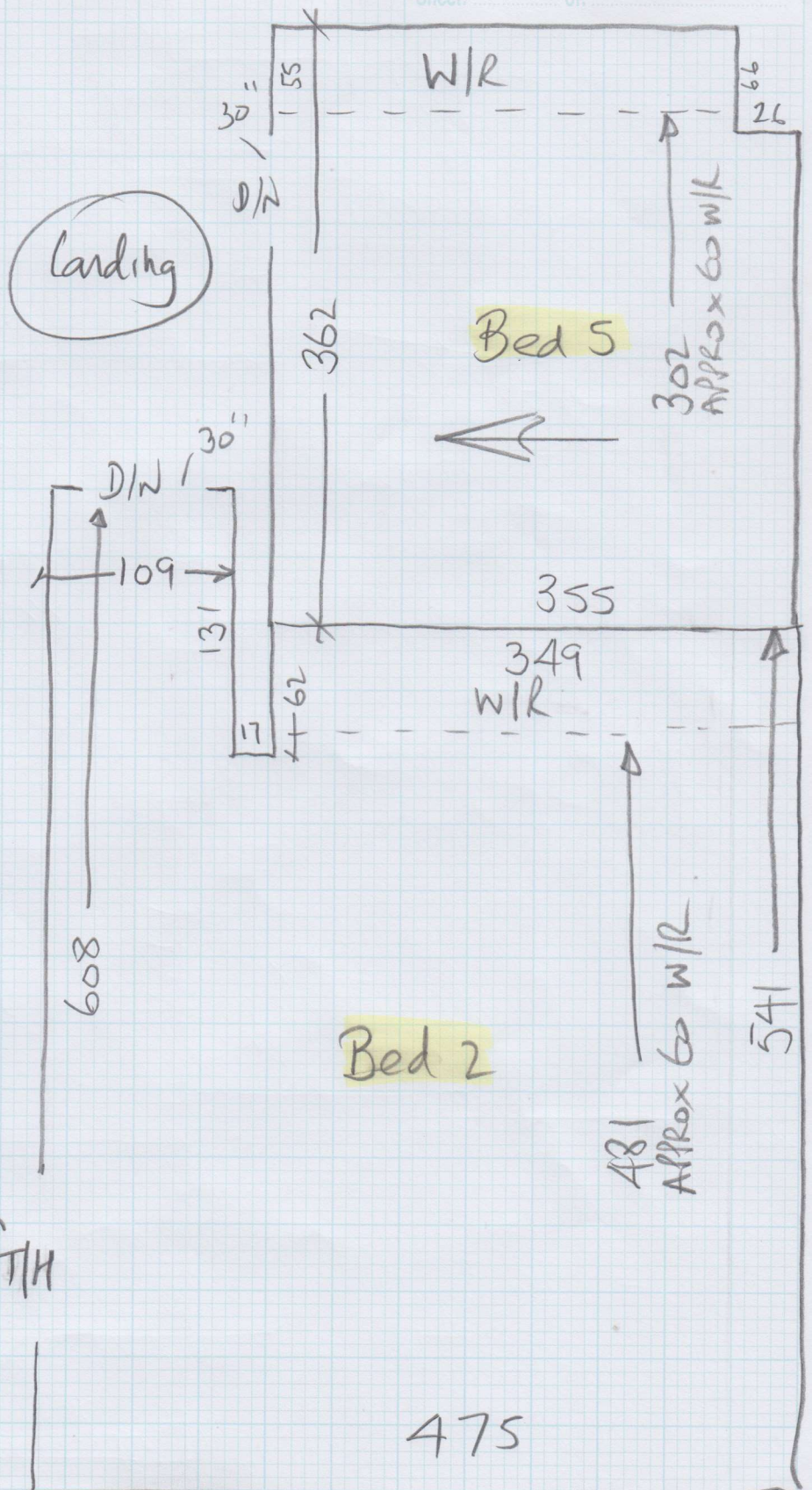

Concrete.

2mm  
T/H

# STAIRS Grand - 1ST floor

mrcarpets

Job No: P27151  
Name: Charbridge

Address:  
Tel:  
Sheet: 12 of 14

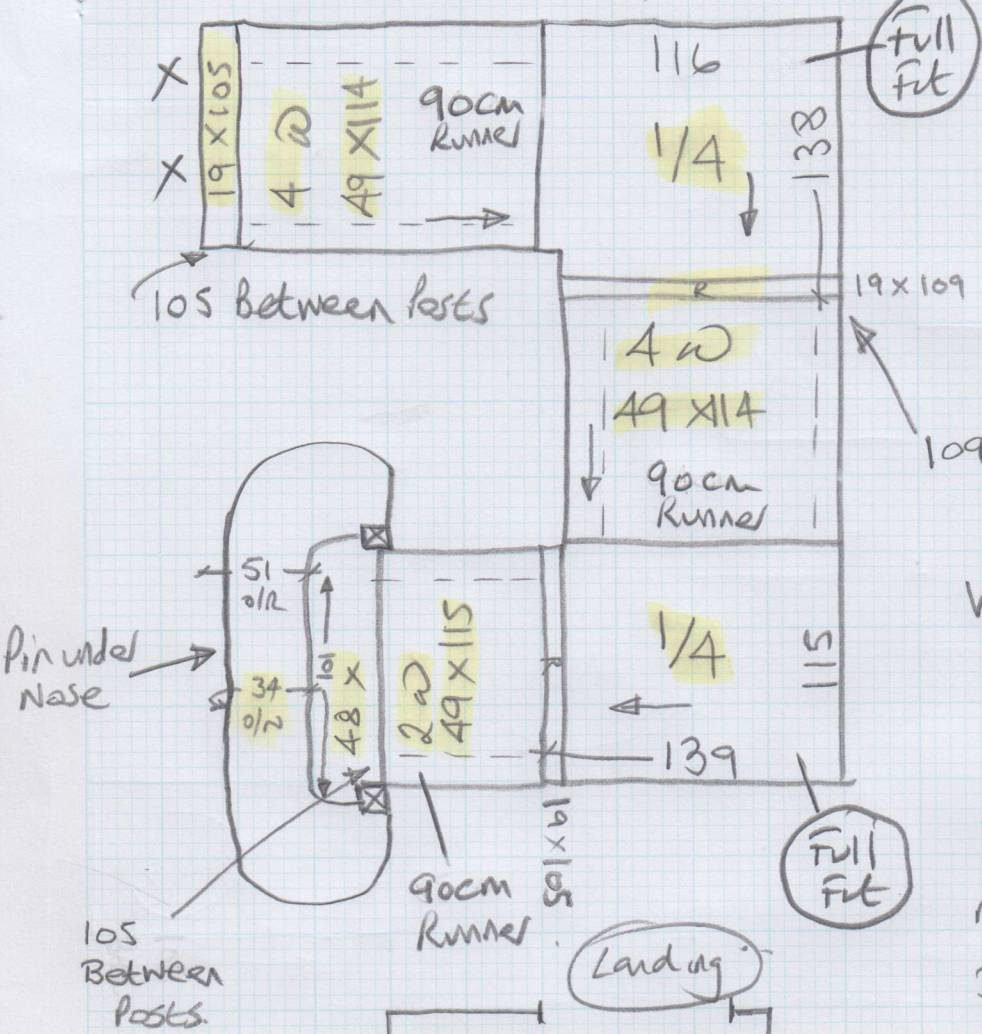

Wood floors

## Rods

- Top. 5
- middle 5
- Bottom 4

14.

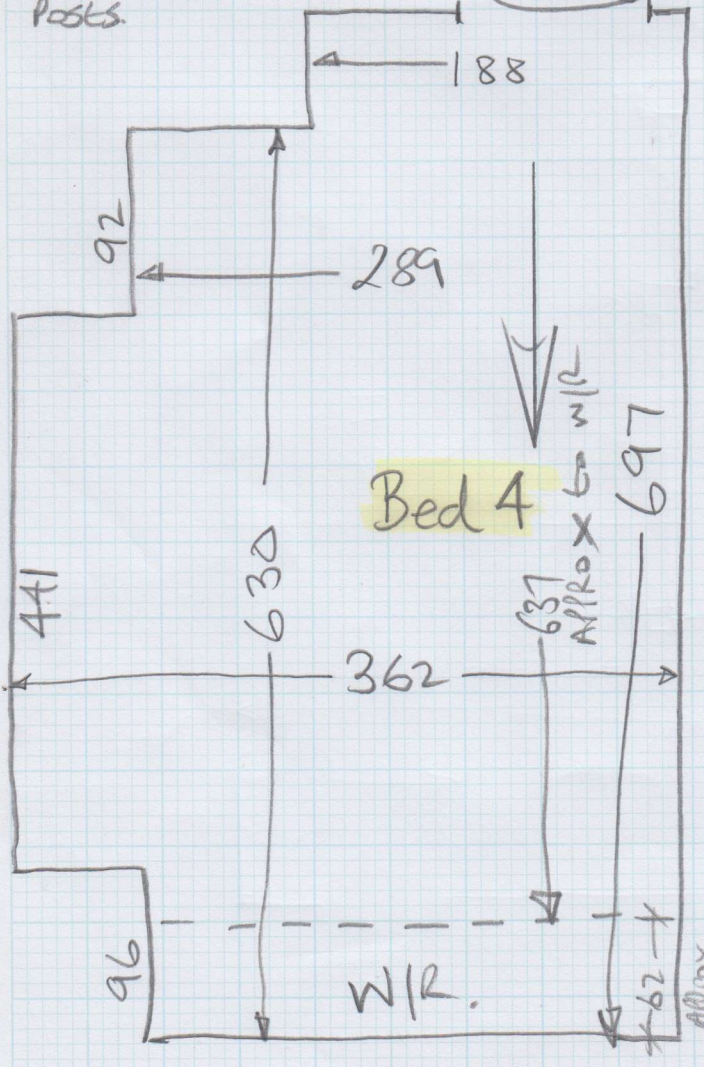

## 1ST floor



Job No: P2M151  
Name: Chartridge

Address:

Tel:

Sheet:

14 of 14

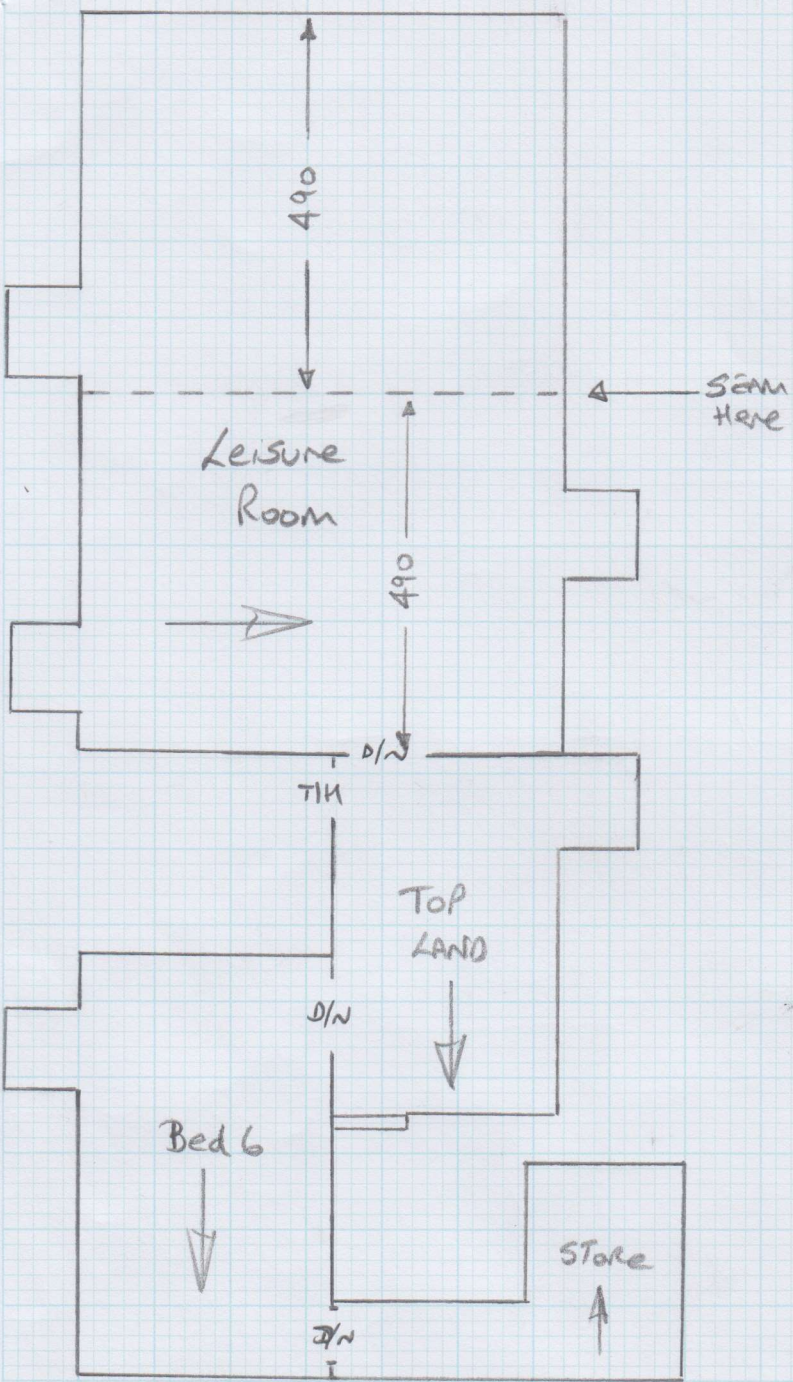

Top Floor layout plan

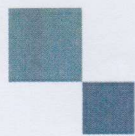

mrcarpet

DESIGNS FOR FLOORS

70 Lower Richmond Road  
Putney  
SW15 1LL

Tel Nr: 020-8789 3133

Fax Nr: 020-8780 2140

## ROLL BREAKDOWN

---

Job No: P27151

Customer Name: Chartridge Developments

Carpet: Appleby 50 (Victoria Twist 50)

Colour: AP50-46N (Calibre)

All rolls are 5m wide Rolls

Roll A	Roll B	Roll C
30.00	28.50	28.50
15.00*	11.60*	11.60*
11.10	9.30	8.35
3.20	7.15	4.55
		3.65

0.70

0.45

0.35

0.00

**\* Cut these pieces last on each roll & leave the roll balances on them**