

Ground floor
Drawing Room

Job No: R19815
Name: Fraser
Address:
Tel: (1 of 9)
Sheet:

Elysian Velvet Divine
Colour Ice

Cut Plan 735×500
 $= \underline{36.75m^2}$

Filler (A) 335×100
 $= \underline{3.35m^2}$

Total = 40.10m²

v/Lay = $37.50m^2$

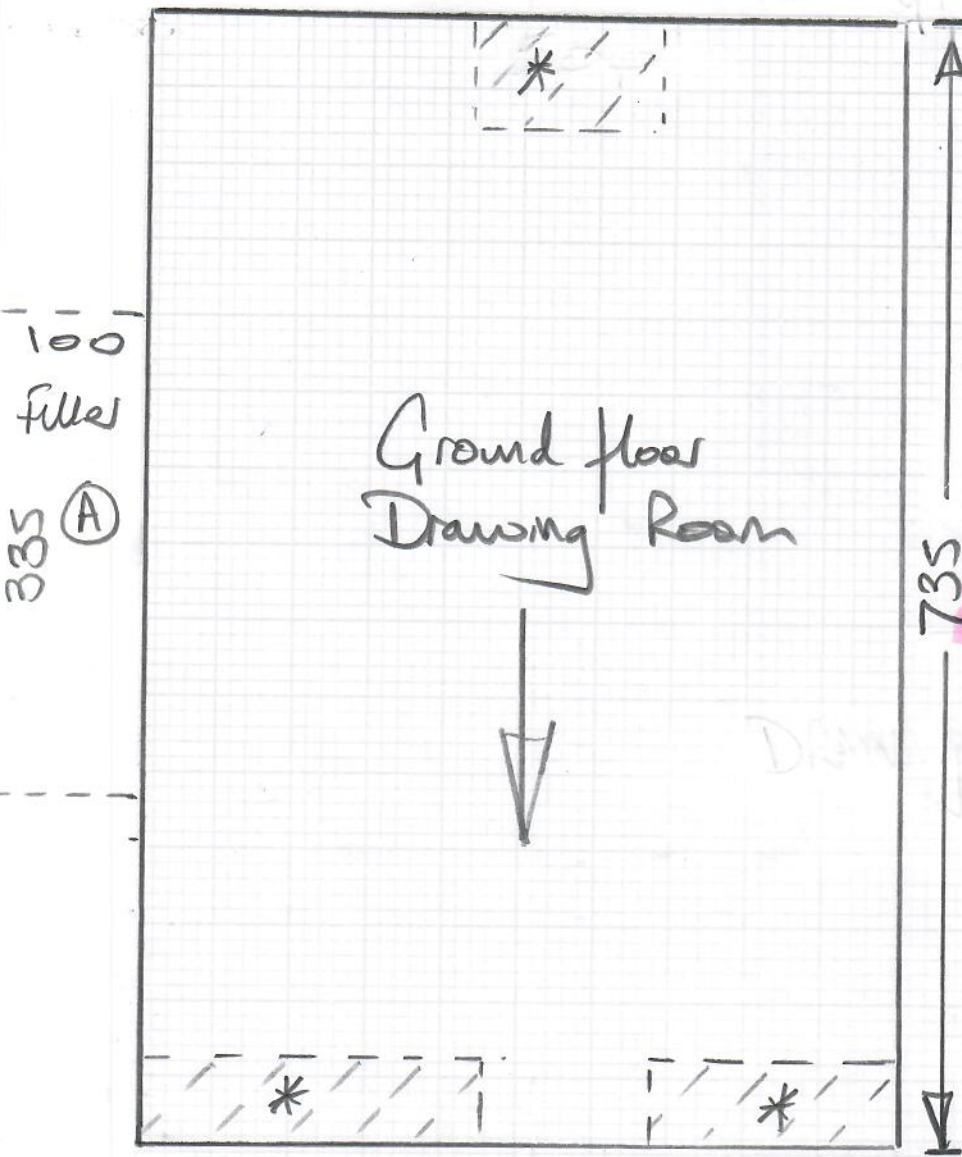

* Cut waste out on site
leave with customer
for Mats

Must order 5m wide + 1m wide to
Colour Match.

Ground floor Drawing Room

mrcarpet
DESIGNS FOR FLOORS

Job No: R19815
Name: Fraser
Address:

Tel:
Sheet: 2 of 9

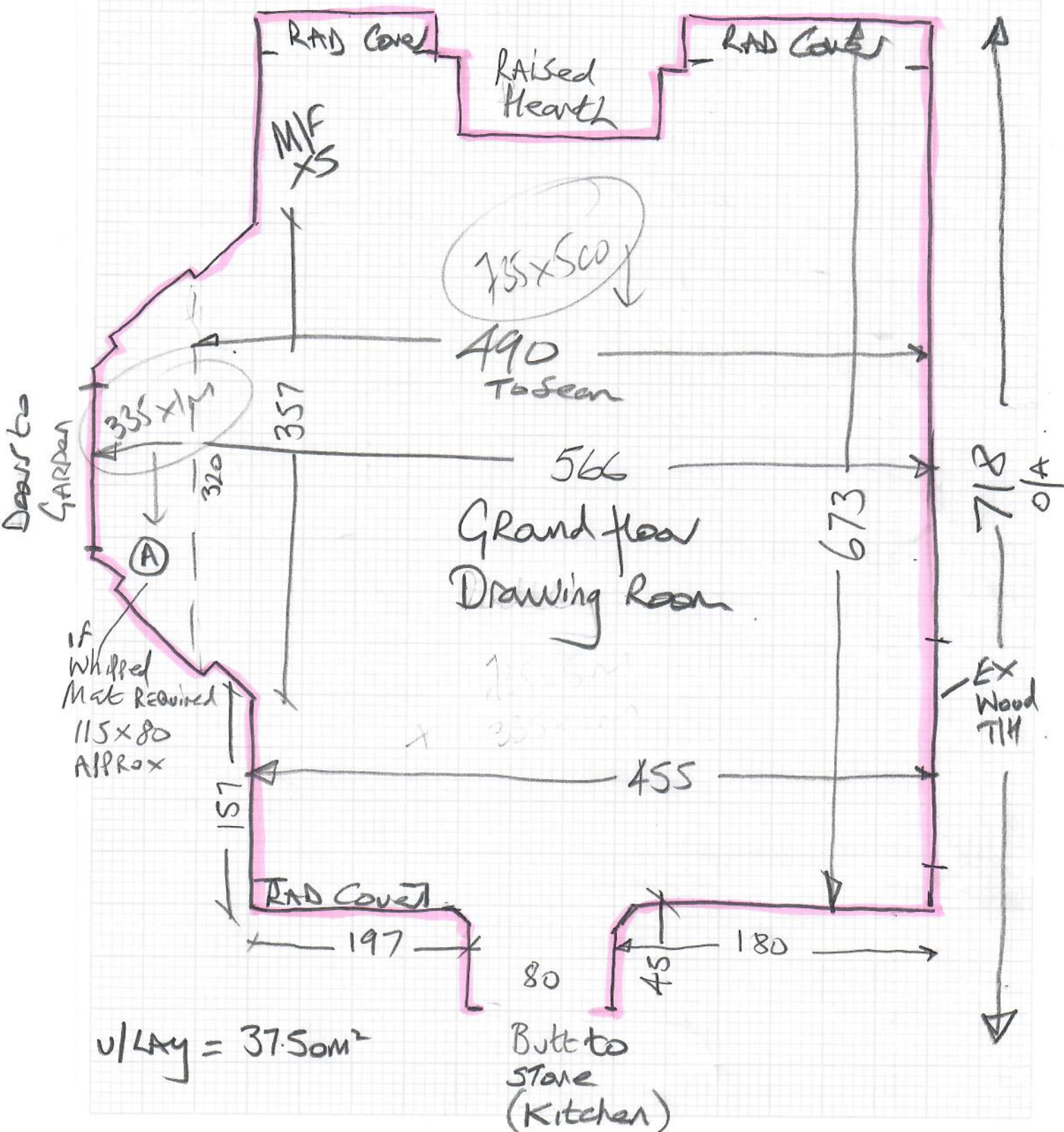

$U/LAY = 37.50m^2$

Top floor Beds

mrcarpet
DESIGNS FOR FLOORS

Job No: R19815
Name: Fraser
Address:
Tel:
Sheet: (3 of 9)

Elysian Divine
Col. Pearl.

Top floor Rear Bed 475×500
= $23.75m^2$

u/Lay = $22m^2$

TOP floor front Bed 625×500
= $31.25m^2$

u/Lay = $28m^2$

* Please drop any waste from these
2 rooms to Haynes LARK Shop when
finished for use in doorbar displays

Job No: R19815
Name: Fraser
Address:

Tel: (409)

2nd floor

v/Lay = 22m²

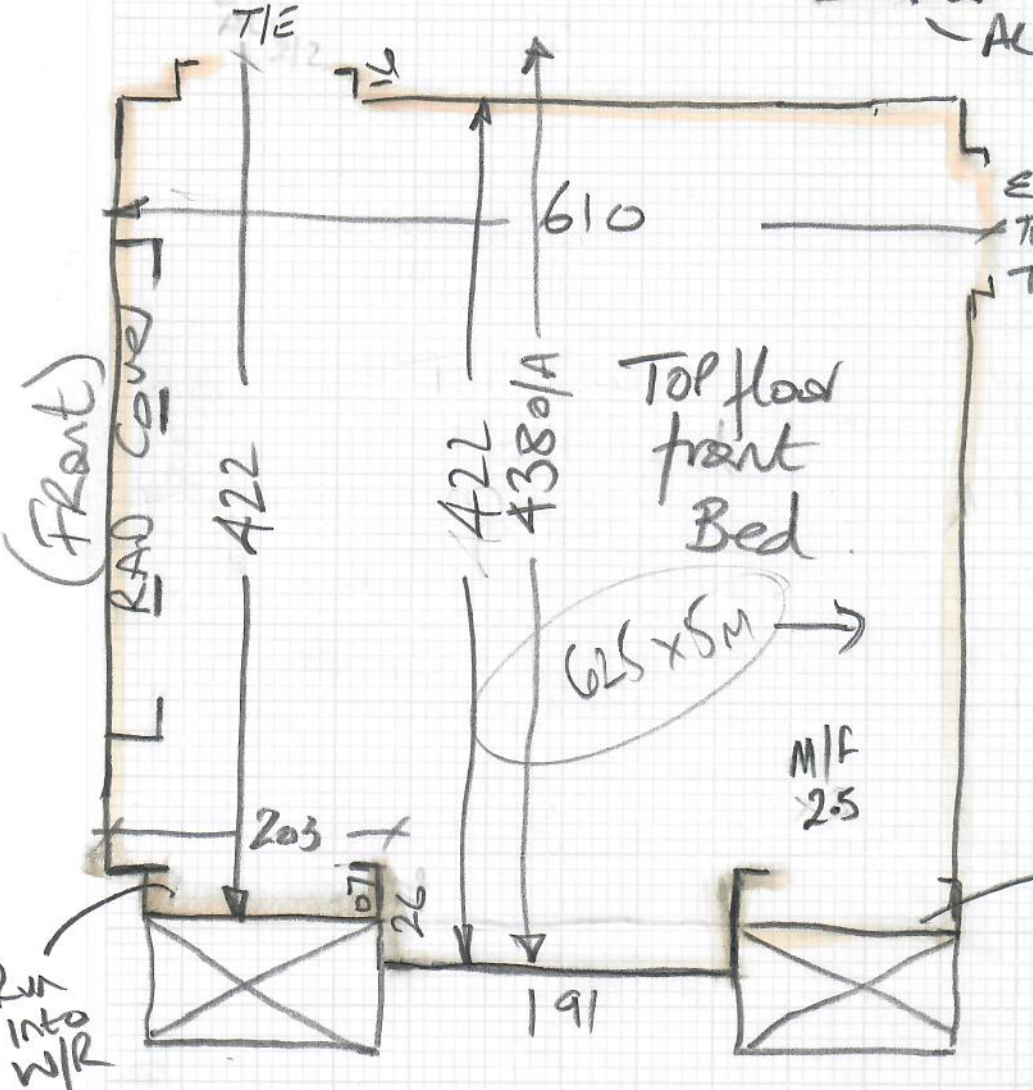
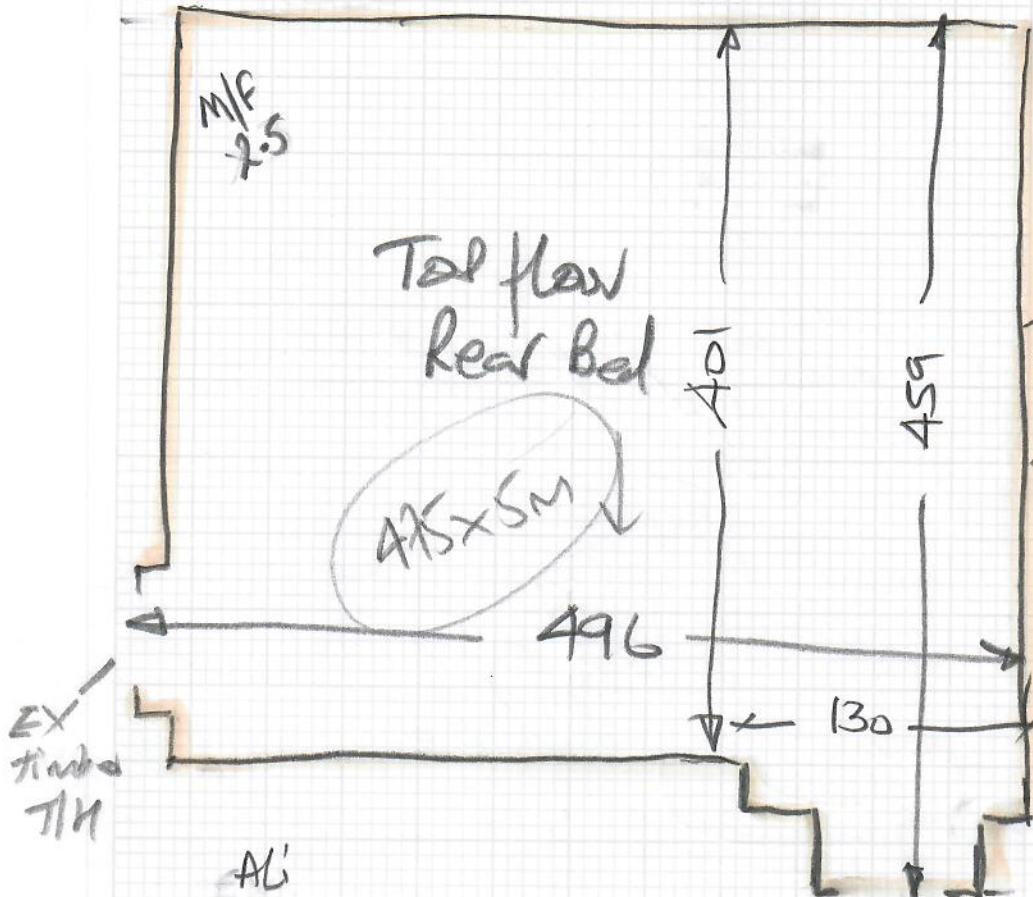

v/Lay = 28m²

Run into w/Robe

Run into w/R

Master Bed Suite

mrcarpet
DESIGNS FOR FLOORS

Job No: R19815
Name: Fraser
Address:
Tel:
Sheet: 5 of 9

WEST END PRISTIGE
Colour Sheepskin

$$\text{M/Bedroom} = 740 \times 500 \\ = \underline{37\text{m}^2}$$

$$\begin{array}{r} \text{EMMAS Dressing Rm} \quad 410 \times 400 \\ \text{Norman's Dressing Rm} \quad 210 \times 400 \\ \hline 6.20 \times 400 \\ = \underline{24.80\text{m}^2} \end{array}$$

$$\text{Total} = \underline{\underline{61.80\text{m}^2}}$$

$$\text{u/Lay} = 53\text{m}^2$$

ORDER 4m + 5m Wide to Colour Match

Cut Waste from 2 Dressing Rooms out on site & leave with Carter to make Mats for Dog to Lay on

Job No: R19815

Name: Fraser

Address:

Tel:

Sheet:

6 of 9

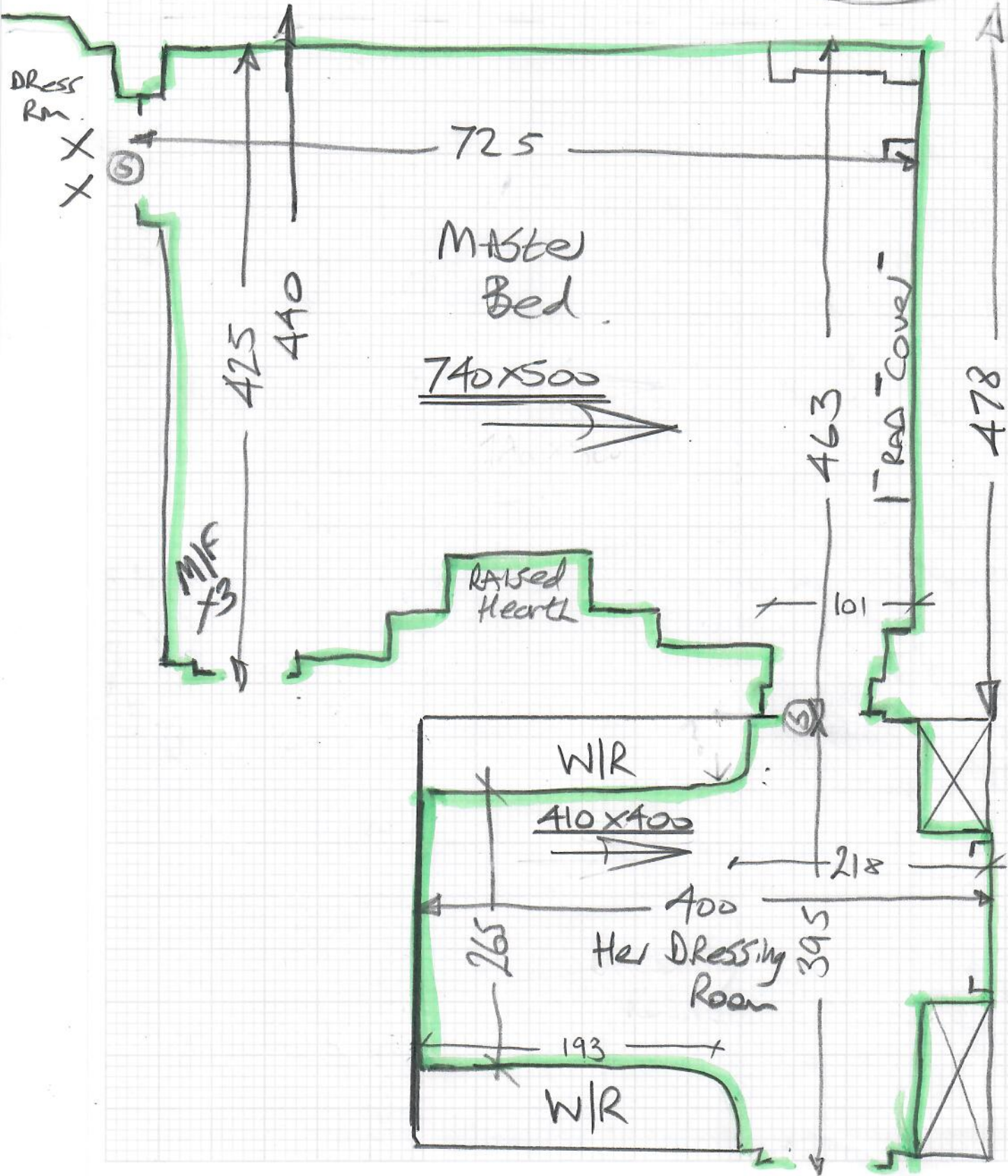

Job No: R19815
Name: fraser
Address:

Tel:
Sheet: 7 of 9

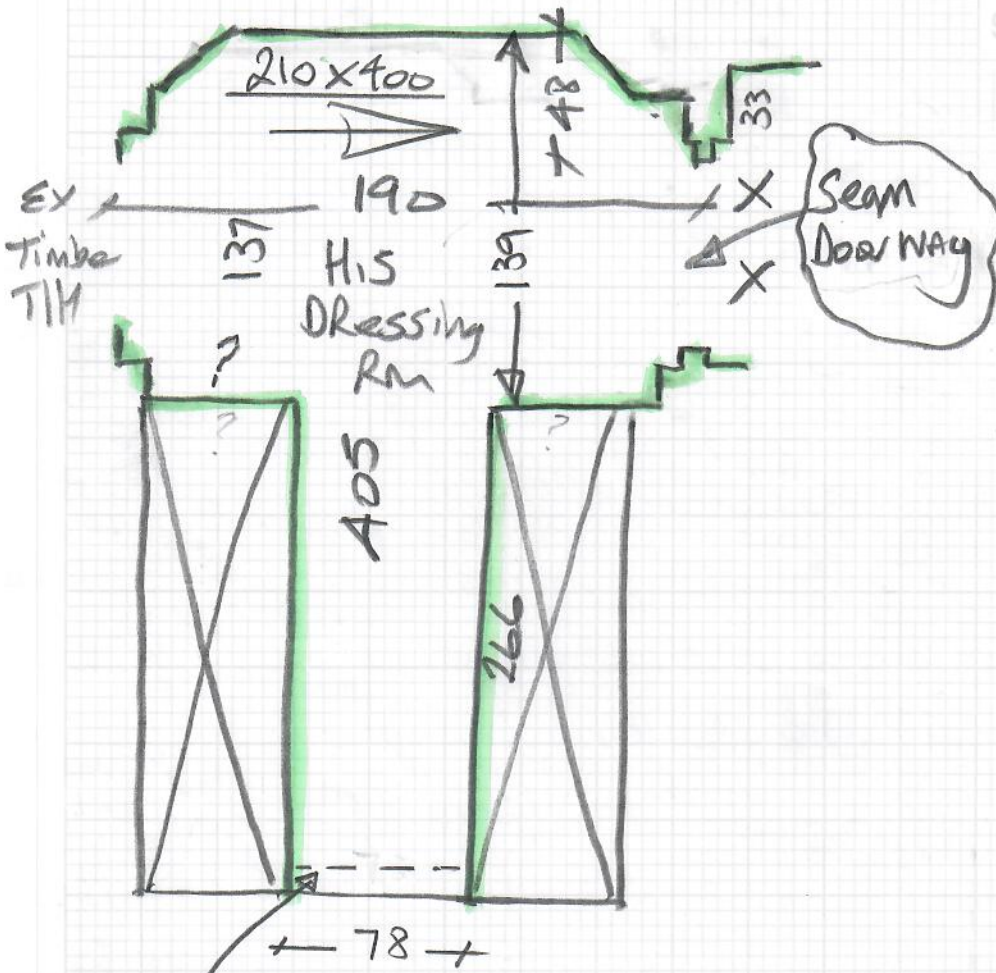

M/Bed
→

Seam
Here

240	90	90	90	130
	5T	2T 90	W2 120	W1 90
		RISE 120		W3 90
	<u>SPARE</u>	W4 120		<u>SPARE</u> 60

BASEMENT STAIRS

mrcarpet
DESIGNS FOR FLOORS

Job No: R19815

Name: Fraser

Address:

Tel:

Sheet:

8 of 9

Ludlow

Col. LUD-121

Cut Plan 240×400
 $= \underline{\underline{9.60m^2}}$

$v/hay = 7m^2$

Basement STRS

Job No: R19815
Name: FRASEL
Address:

Tel:
Sheet: 9 of 9

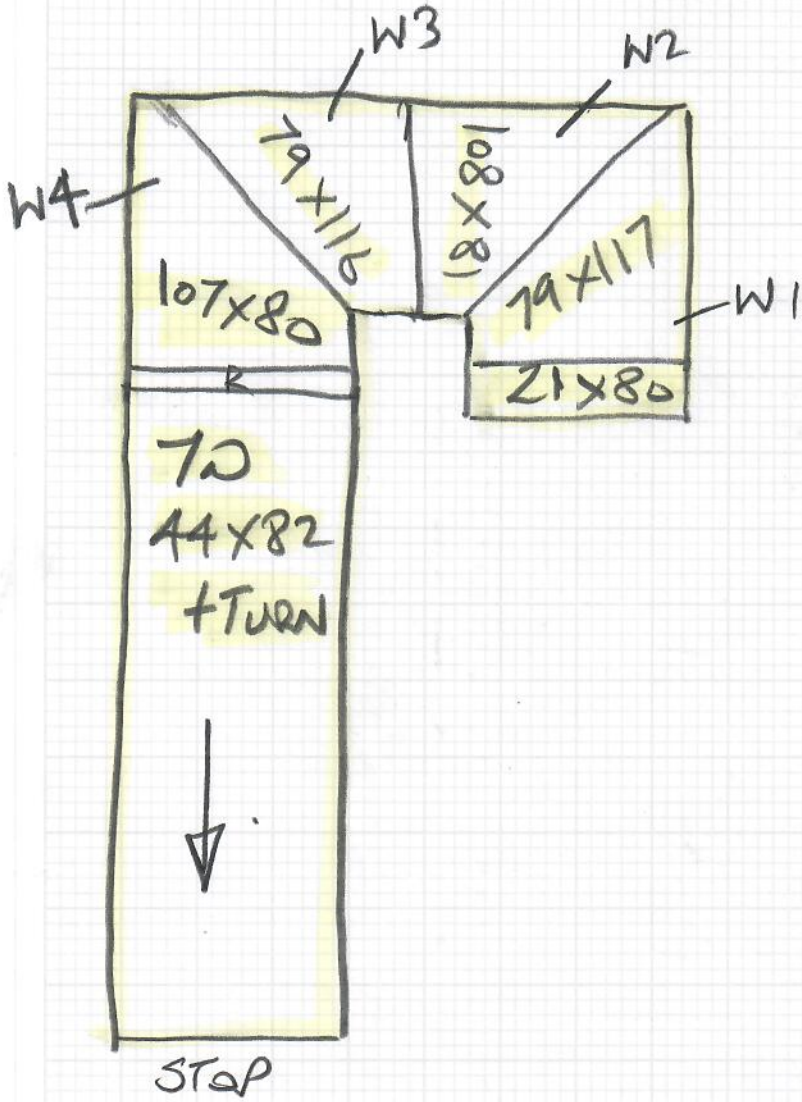

Ludlow
Col. LUD-121