

Job No: 3174

Name: PRANSLEY

Address:

Tel:

Sheet: (1) OF (4)

NOTE
DIFF CUTS

✓ REAR BED 2.95 x 4m
- PANDA GL 19

✓ PLAN 1 3.100 x 5m

✓ PLAN 2 1.80 x 4m

✓ PLAN 3 2.70 x 4m ✓
(LOFT STAIRS)

✓ PLAN 4 1.40 x 4m ✓

✓ PLAN 5 2.20 x 4m ✓
(MAIN STAIRS)
SEE (P2)

PLEASE
CUT FROM

4.85 x 4m
BUSTON

GL 27

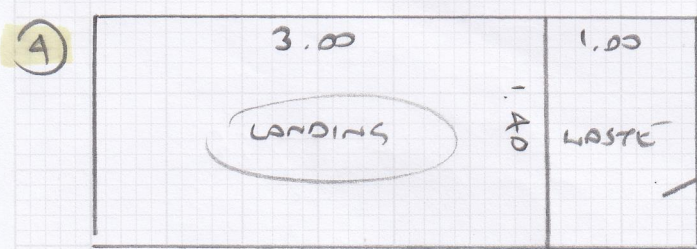
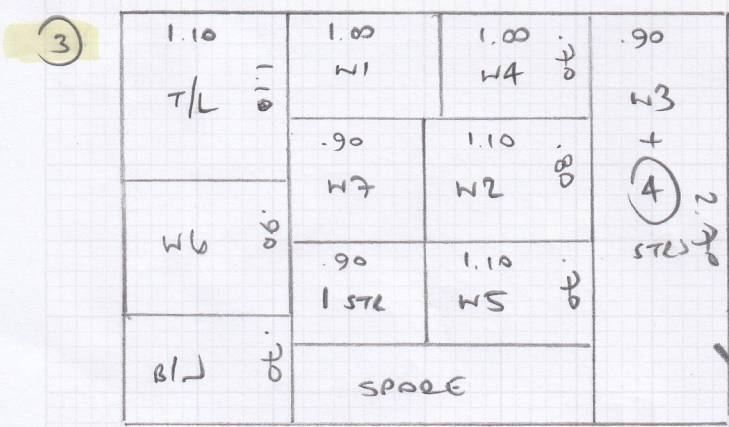
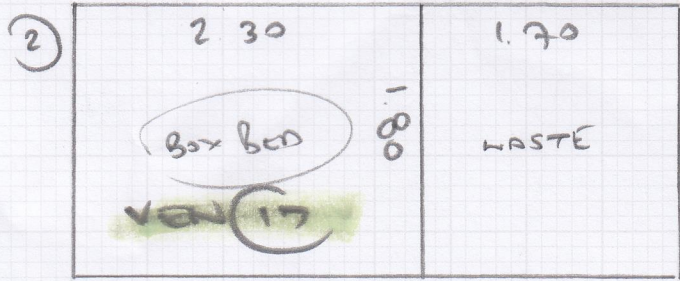
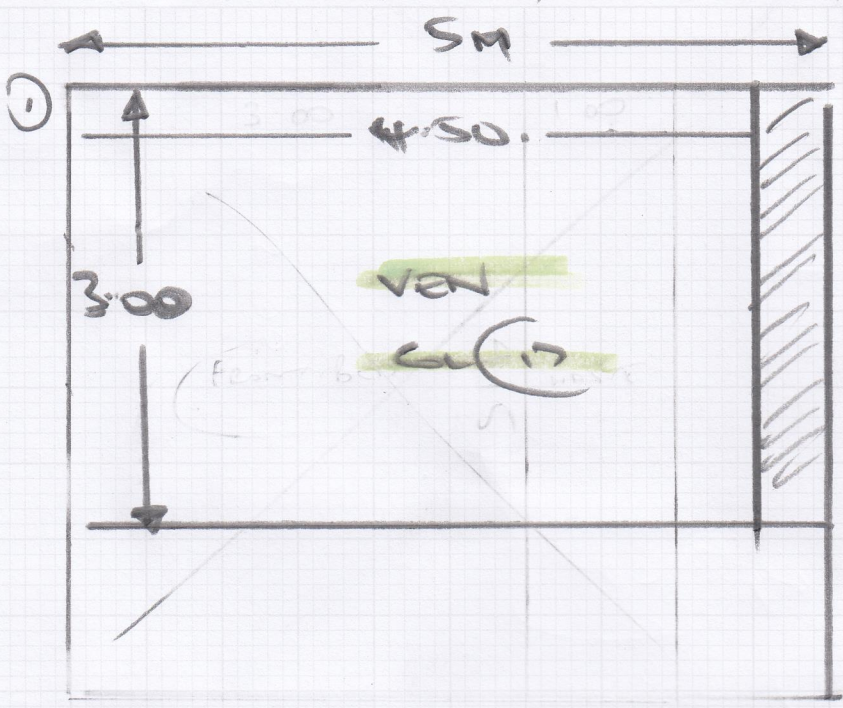

⑤	.90 RISER + ④	.90 ④ 2.20	1.20 W9	1.00 28 0
			.90 W10 + - 1.40	1.30 8/2 0
			1 STRCS 0	

mrcarpet
DESIGNS FOR FLOORS

Job No: S31761
 Name: PRANSLEY
 Address: _____
 Tel: _____
 Sh: (2 of 4)

1ST STRIP
 FIT FULL
 WIDTH
 BLUE STRIPE
 IRVINE CPT
 27' 0" PA, W/4"

NOTE (3 BED) 12/17
 LEAVE ALWAYS LOW.

S/L FIT 24/17
 1ST STRIP BLUE STRIPE

REST OF S/L BUS 27'

531761

Job No:

Name: PRANGLEY

Address:

Tel:

Sheet: NOT LOT of BED

(3 of 4)

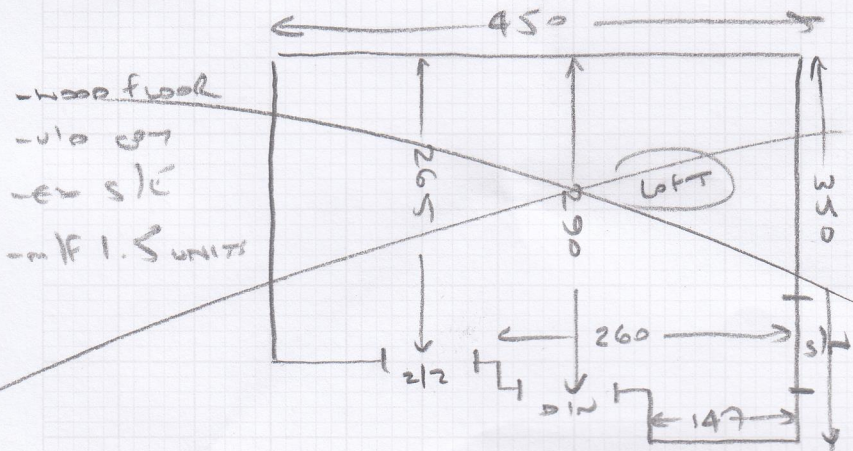

LAYOUT ONLY

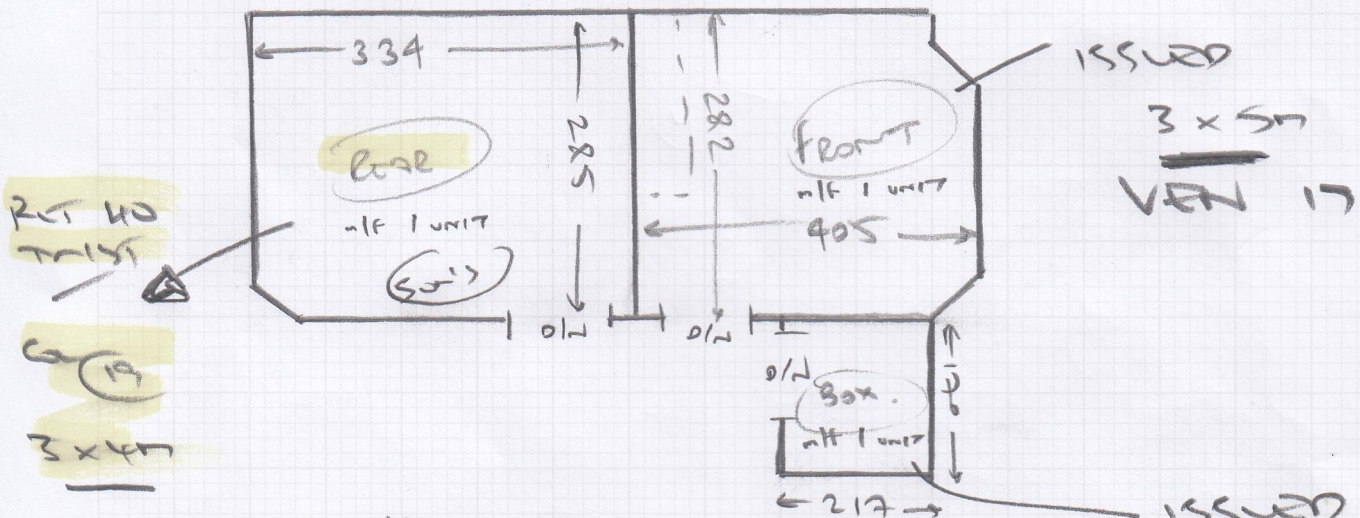

- wood floors
- u/c cpts
- ex s/c
- m/f see rooms

ISSUED
 1.80x
 4m
 VENT 17

(S 31761

Job Name: PRANGLEY

Address:

Tel:

Sheet: (4) of (4)

✓ rlc	96	96	(1x dlw)
✓ 1e	46	74	
✓ w1	61	83	
✓ w2	70	101	
✓ w3	66	73	
✓ 4e	46	73	
✓ w4	55	80	
✓ w5	60	105	
✓ w6	75	101	
✓ w7	55	75	
✓ blw	46	101	

- NOOD fudds

- no uld

- ex slE

(h,)

1st front
STRIP

REST OF

S/L

BUSTON

GA BUS 027

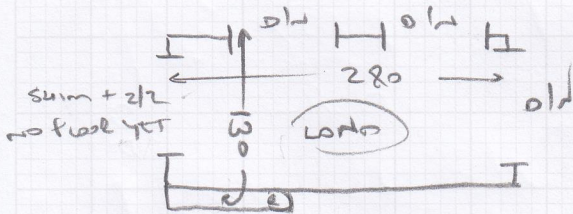

Riser	20	85
w8	63	85
w9	70	110
w10	66	75
10e	44	75
blw	45	92

