

Job No: KEVIN HILL

Name: _____

Address: _____

Tel: _____

Sheet: 1 OF 2 of _____

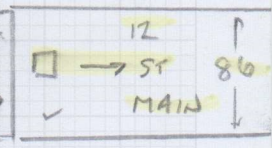
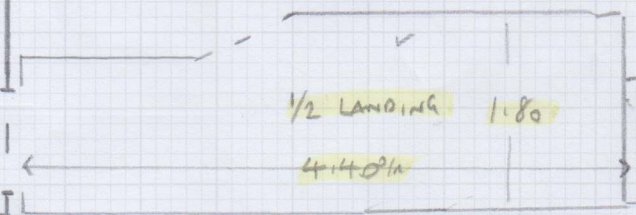
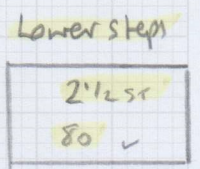
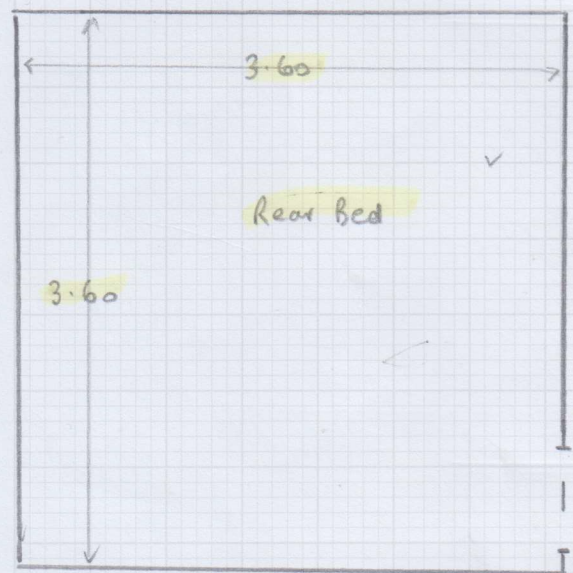
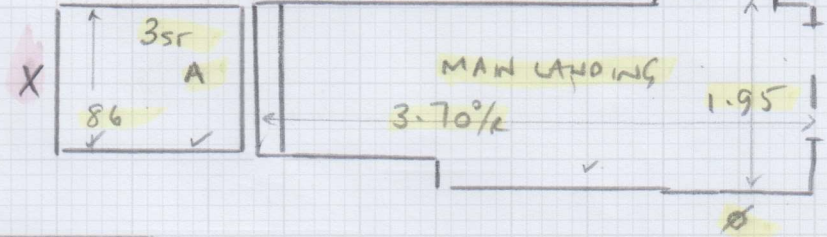
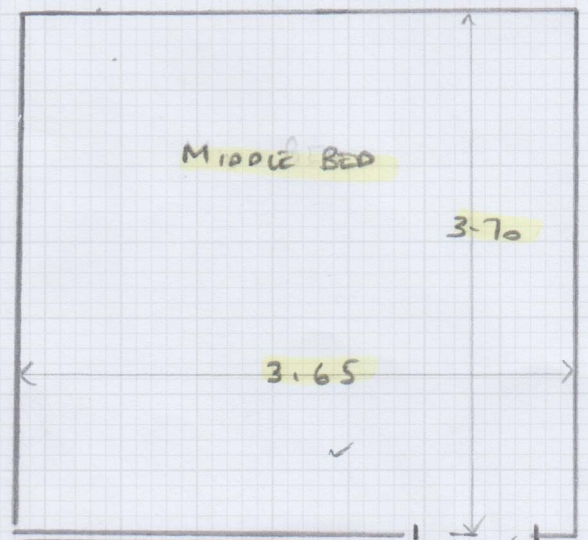
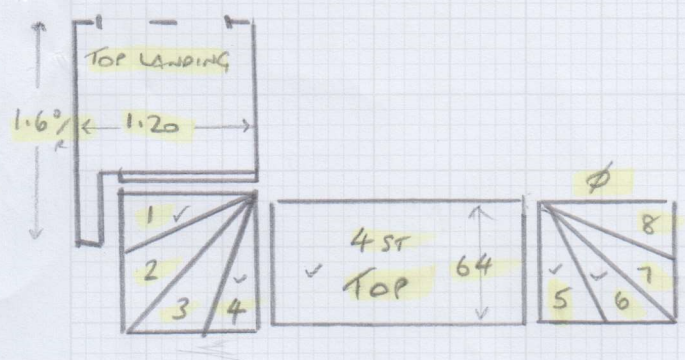

Job No: KEVIN HU

Name: _____

Address: _____

Tel: _____

Sheet: 2 of 2

CUTS + PLANS

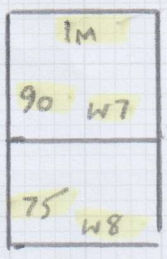

CUTS

Plan = 15.75 x 1M STAIN + W'S

3.70 x 4M Rear bed

3.80 x 4M MIDDLE BED

Plan = 5.50 x 4M 1/2 + MAIN LAND

- 1M
- 6.0
- 12 MAIN ST
- Lower steps 1.50
- 3x A 1.50
- 4st Top 2.0
- 70 W1
- 80 W4
- 80 W5
- 80 W6

4M

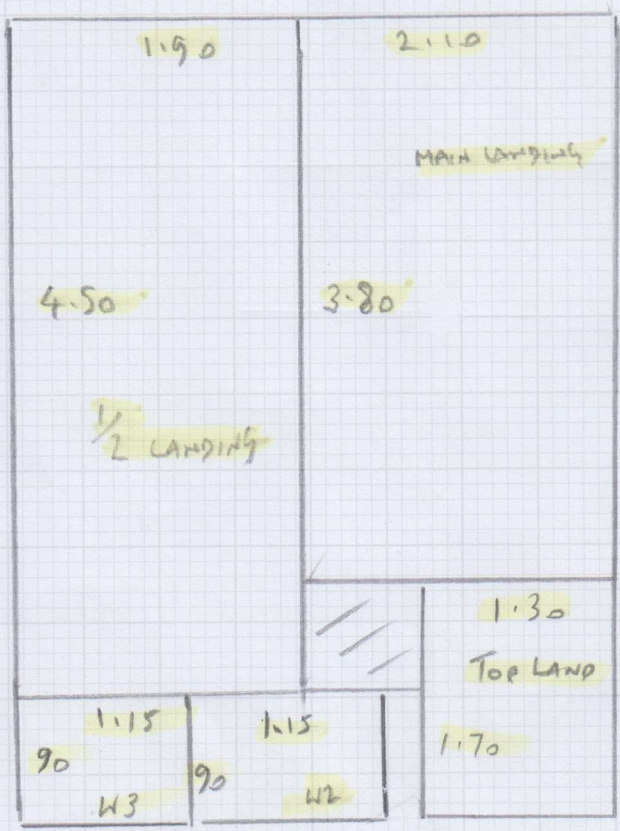

67.75² M

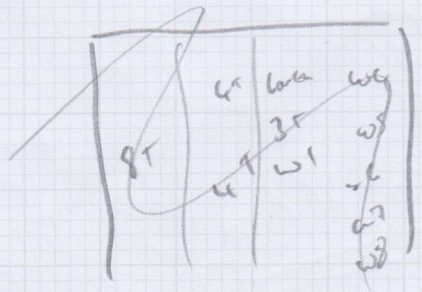

15.75
14.75
13.75
12.75
11.75
10.75
9.75
8.75
7.75
6.75
5.75
4.75
3.75
2.75
1.75
0.75
0.25